

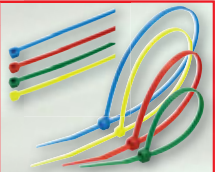

Klasické sťahovacie pásky 2



Klasické sťahovacie pásky farebné 3



Sťahovacie pásky s kovovým jazýčkom, čierne 4

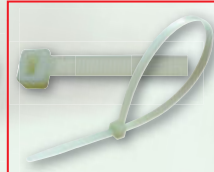

Sťahovacie pásky so zvýšenou tepelnou odolnosťou 4



Sťahovacie pásky s dvoma jazýčkami 5



Sťahovacie pásky pre viacnásobné použitie 5



Sťahovacie pásky perličkové, rozpinacie 6

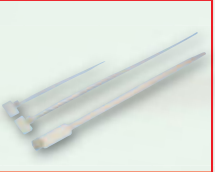

Sťahovacie pásky so štítkom 6



Sťahovacia páska so zastrkávacou hlavou 7

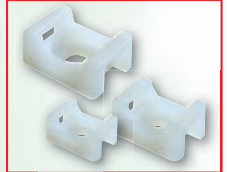

Skrutkovacie pátky k sťahovacím páskam 7

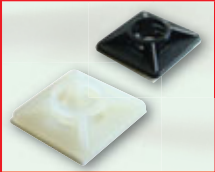

Samolepiace pátky k sťahovacím páskam 8

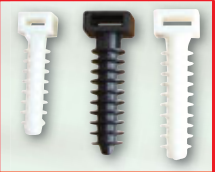

Zatlačiacie hmoždinky k sťahovacím páskam 9



Prichytky na káble, s klincom 10



Samoupinacie prichytky 10

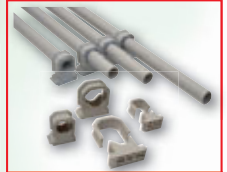

Umelohmotné káblové prichytky 11



Hmoždinky na uchytienie káblov 11



Hmoždinky s profilovými skrutkami 12



Hmoždinky lemované, so šesťhrannou skrutkou 12



Hmoždinky nylon s vysokou zaťažiteľnosťou 13

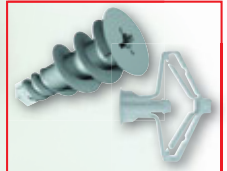

Hmoždinky do sádkartónu 13



Hmoždinky polyetylénové 14



Hmoždinky so zatlačacou skrutkou 14



Hmoždinky dlhé, PA6.6 14



Hmoždinky lemované 15



Hmoždinky uzlovacie 15



Sklápacie závesy do dutých priestorov 16



Lanové očnice 16



Háky "S" 17



Lanové svorky, profil "U" 17



Lanové svorky dvoj-skrutkové "duplex" 18



Lanové svorky ploché "AMAX" 18



Karabiny so skrutkou 19



Napínacie skrutky 20



Káblové zväzovacie špirály 21



Plastové zväzovacie sieťky 21

## C/O Vysvetlenie piktogramov hlavičky tabuliek

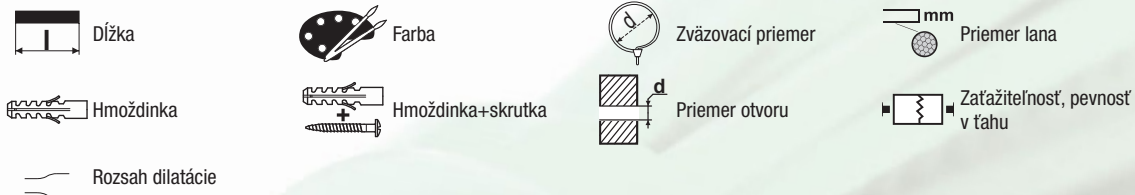

## C/O Piktogramy technických parametrov

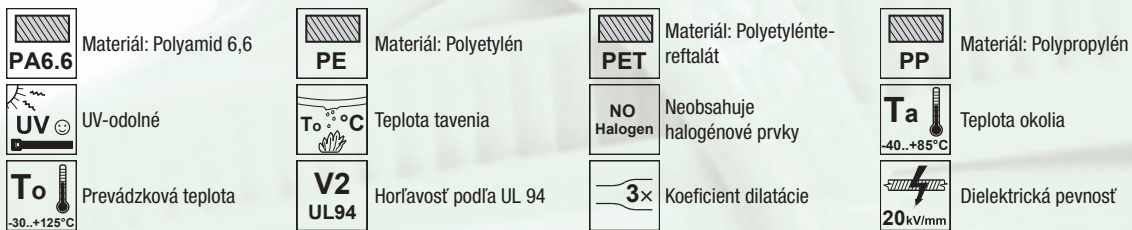

## Klasické sťahovacie pásky



C/O

TRACON						
<b>80PR</b>		<b>81PR</b>		75 × 2.2 mm	0.75-15 mm	35 N
<b>120PR</b>		<b>121PR</b>		98 × 2.5 mm	1-21 mm	45 N
<b>130PR</b>		<b>131PR</b>		135 × 2.6 mm	1-32 mm	45 N
<b>150PR</b>		<b>151PR</b>		140 × 3.6 mm	2-36 mm	80 N
<b>160PR</b>		<b>161PR</b>		160 × 2.6 mm	1-40 mm	45 N
<b>180PR</b>		<b>181PR</b>		180 × 7.8 mm	3.5-45 mm	250 N
<b>200PR</b>		<b>201PR</b>		200 × 2.6 mm	1-52 mm	45 N
<b>170PR</b>		<b>171PR</b>		200 × 3.6 mm	2-50 mm	80 N
<b>190PR</b>		<b>191PR</b>		200 × 4.8 mm	3-50 mm	110 N
<b>250PR</b>		<b>251PR</b>		250 × 4.8 mm	3-68 mm	110 N
<b>280PR</b>		<b>281PR</b>		280 × 8.0 mm	4-65 mm	180 N
<b>230PR</b>		<b>231PR</b>		290 × 3.6 mm	2-80 mm	80 N
<b>210PR</b>		<b>211PR</b>		290 × 4.8 mm	3.5-79 mm	110 N
<b>300PR</b>		<b>301PR</b>		300 × 7.8 mm	5-80 mm	250 N
<b>220PR</b>		<b>221PR</b>		360 × 4.8 mm	3.5-103 mm	110 N
<b>260PR</b>		<b>261PR</b>		365 × 7.8 mm	8-100 mm	250 N
<b>370PR</b>		<b>371PR</b>		370 × 3.6 mm	5-108 mm	80 N
<b>430PR</b>		<b>431PR</b>		430 × 4.8 mm	3.5-115 mm	110 N
<b>450PR</b>		<b>451PR</b>		450 × 7.8 mm	35-130 mm	250 N
<b>530PR</b>		<b>531PR</b>		550 × 8 mm	10-160 mm	250 N
<b>540PR</b>		<b>541PR</b>		540 × 7.8 mm	35-158 mm	250 N
<b>760PR</b>		<b>761PR</b>		780 × 9 mm	35-233 mm	350 N
<b>850PR</b>		<b>851PR</b>		850 × 12.6 mm	40-255 mm	450 N
<b>1000PR</b>		<b>1001PR</b>		1000 × 12.6 mm	40-302 mm	450 N

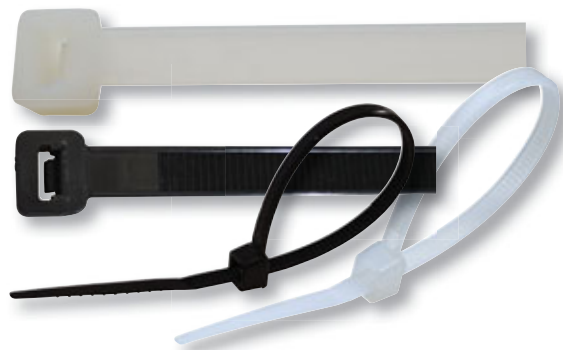

RELEVANT STANDARD  
EN 62275



### Vlastnosti:

Trvale odolné voči olejom, benzínu, derivátom uhlíkovdika, syntetickým rozpúšťadlám, plesniam, alkoholom.

Krátkodobu odolné voči organickým kyselinám, zásadám, anorganickým soľam a organickým látkam.

Nie sú odolné voči anorganickým kyselinám a oxidačným prípravkom.

B/14

TG008



TG007



TG010



## Klasické sťahovacie pásky farebné

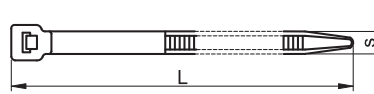
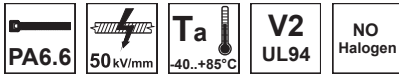

TRACON					
<b>120K</b>		98 × 2.5 mm	1-21 mm	45 N	
<b>150P</b>		140 × 3.6 mm	2-36 mm	80 N	
<b>150Z</b>		140 × 3.6 mm	2-36 mm	80 N	
<b>200K</b>		200 × 2.6 mm	1-52 mm	45 N	
<b>170K</b>		200 × 3.6 mm	2-50 mm	80 N	
<b>170P</b>		200 × 3.6 mm	2-50 mm	80 N	
<b>190K</b>		200 × 4.8 mm	3-50 mm	110 N	
<b>230NZ</b>		290 × 3.6 mm	2-80 mm	80 N	

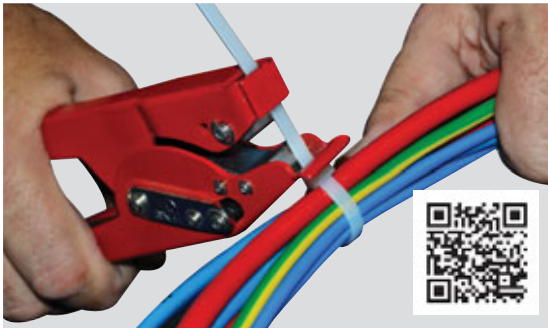

RELEVANT STANDARD  
EN 62275

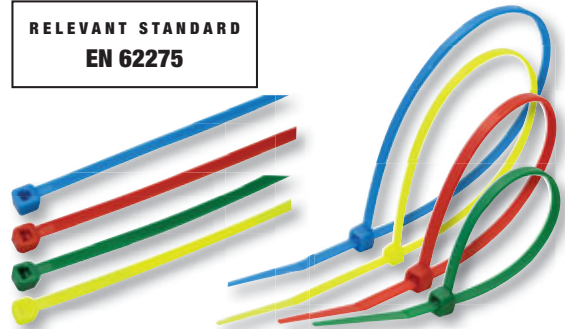

## Sťahovacie pásky s kovovým jazýčkom, prírodné

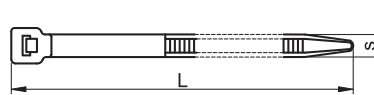
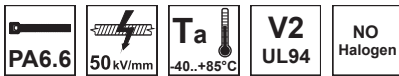

TRACON				
<b>T92</b>		92 × 2.4 mm	2-16 mm	35 N
<b>T140</b>		140 × 3.6 mm	2-29 mm	75 N
<b>T186</b>		186 × 4.8 mm	3.5-45 mm	110 N
<b>T200</b>		200 × 2.4 mm	2-50 mm	35 N
<b>T208</b>		208 × 3.6 mm	2-50 mm	75 N
<b>T281</b>		281 × 3.6 mm	2-76 mm	75 N
<b>T293</b>		293 × 4.8 mm	3.5-78 mm	110 N
<b>T338</b>		338 × 7.6 mm	3.5-120 mm	110 N
<b>T360</b>		360 × 4.8 mm	3.5-102 mm	110 N





## Sťahovacie pásky s kovovým jazyčkom, čierne

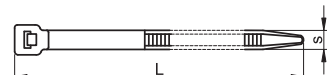

TRACON				
<b>TU92</b>		92 × 2.4 mm	2-16 mm	35 N
<b>TU140</b>		140 × 3.6 mm	2-29 mm	75 N
<b>TU186</b>		186 × 4.8 mm	3.5-45 mm	110 N
<b>TU200</b>		200 × 2.4 mm	2-50 mm	35 N
<b>TU208</b>		208 × 3.6 mm	2-50 mm	75 N
<b>TU281</b>		281 × 3.6 mm	2-76 mm	75 N
<b>TU293</b>		293 × 4.8 mm	3.5-78 mm	110 N
<b>TU338</b>		338 × 7.6 mm	3.5-120 mm	110 N
<b>TU360</b>		360 × 4.8 mm	3.5-102 mm	110 N



## Sťahovacie pásky so zvýšenou tepelnou odolnosťou

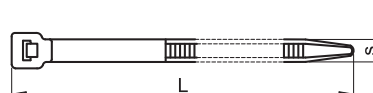

TRACON					
<b>260T</b>		365 × 7.8 mm	8-100 mm	135 °C (5-8 min)	250 N

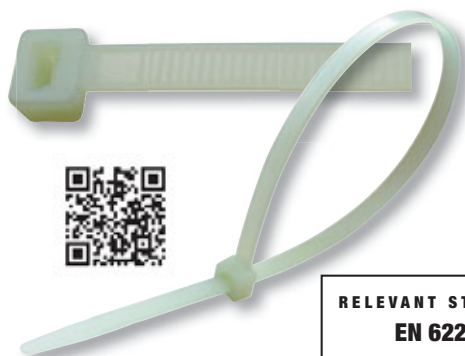

RELEVANT STANDARD  
EN 62275



### NAČITAJTE KÓD!

- Pozrite si naše novinky!
- Buďte informovaný!

Náš sortiment sa neustále a rýchlo rozrastá.  
Predložený katalóg odráža stav k aprílu 2019.  
Pre aktuálne informácie, prosím,  
navštívte našu internetovú stránku!

## Sťahovacie pásky s dvoma jazýčkami

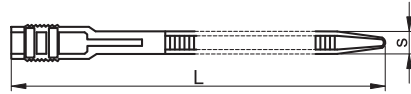
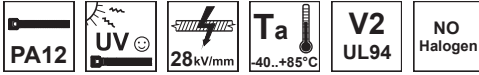

TRACON				
115-12		115 × 6.0 mm	4-25 mm	120 N
132-12		132 × 9.0 mm	4-27 mm	120 N
180-12		180 × 9.0 mm	5-45 mm	150 N
265-12		260 × 9.0 mm	25-65 mm	250 N
300-12		300 × 9.0 mm	25-80 mm	225 N
360-12		350 × 9.0 mm	25-93 mm	250 N

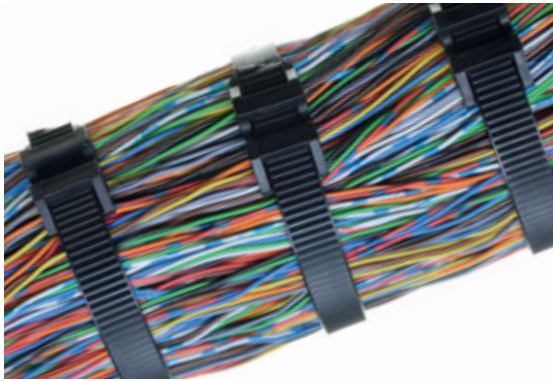

RELEVANT STANDARD  
EN 62275



## Sťahovacie pásky pre viacnásobné použitie

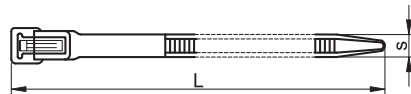
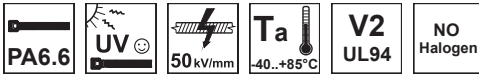

TRACON				
180-NY		200 × 7.5 mm	10-50 mm	10-45 N
260-NY		250 × 7.5 mm	10-65 mm	10-45 N
280-NY		300 × 7.5 mm	10-70 mm	10-45 N
350-NY		350 × 8 mm	10-120 mm	10-45 N



RELEVANT STANDARD  
EN 62275

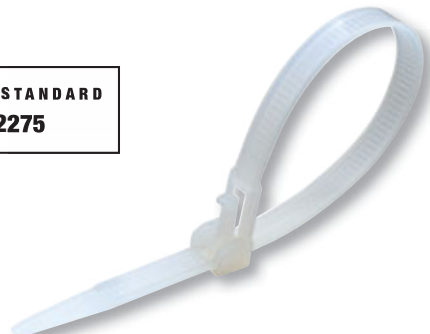

## Sťahovacie pásky perličkové, rozpínacie

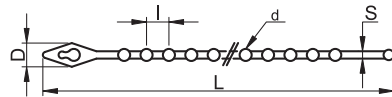
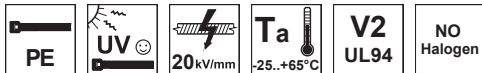

TRACON		L x S (mm)	d (mm)	D (mm)	l (mm)		
120N-GY	120F-GY	120 x 1.3	2.5	5.5	3	6-25 mm	40 N
150N-GY	150F-GY	150 x 2	3	7.5	4.5	8-35 mm	40 N
180N-GY	180F-GY	180 x 2	3	7.5	4.5	8-45 mm	40 N



RELEVANT STANDARD  
EN 62275



## Sťahovacie pásky so štítkom

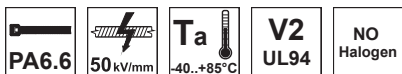

TRACON	L x S (mm)	a (mm)	b (mm)		
190J	190 x 3.6	27	13	10-48 mm	70 N
120J	110 x 2.5	8	25	1-20 mm	40 N
200J	210 x 2.5	15	30	5-45 mm	40 N

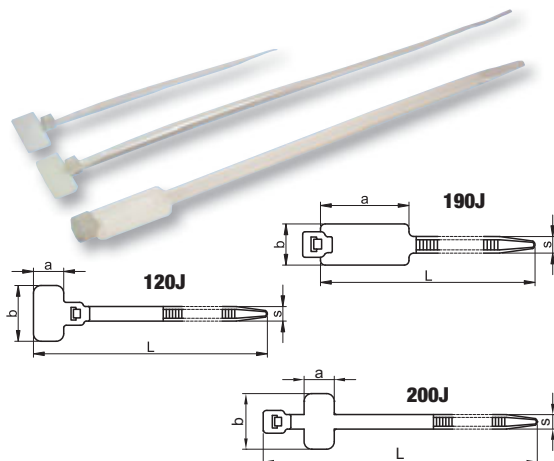

## Sťahovacia páska so zastrkávacou hlavou

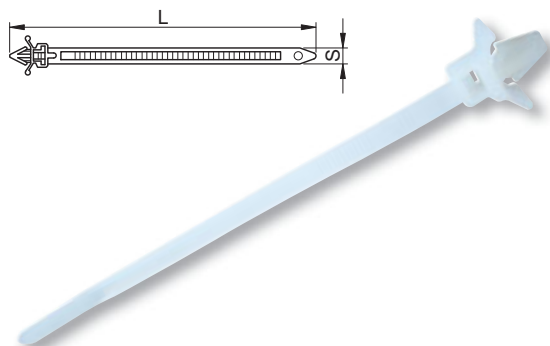
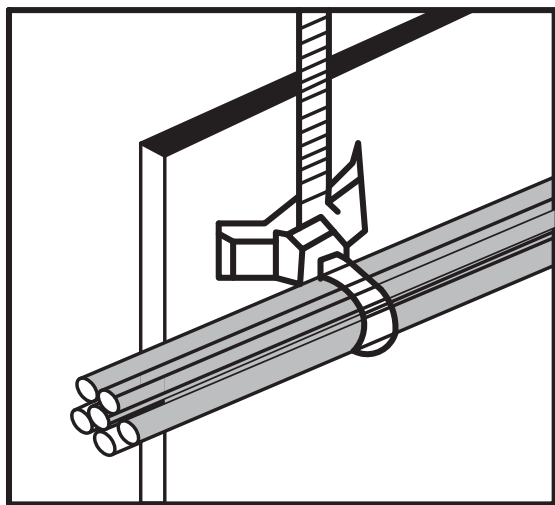
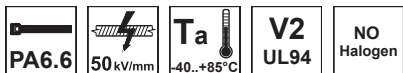

RELEVANT STANDARD  
EN 62275



## Skrutkovacie pätky k sťahovacím páskam

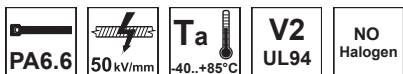

TRACON	a (mm)	b (mm)	L (mm)	d (mm)	D (mm)
CSTALP	15	10	5.1	3.5	7
CSTALP-3	12.8	7	4	3.3	5.8
CSTALP-2	23	16	9	6.3	9.8

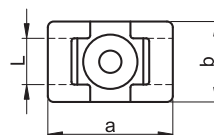
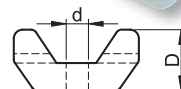
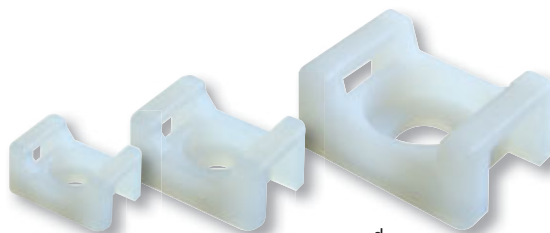
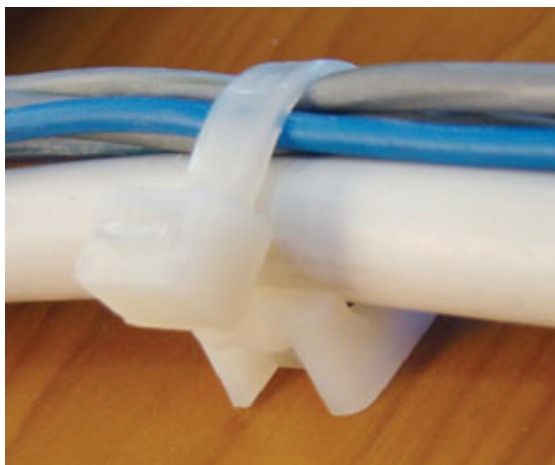



## Dvojvstupové samolepiace pätky k sťahovacím páskam

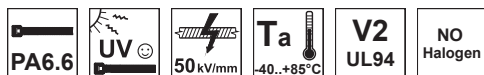

TRACON		a (mm)	b (mm)	L (mm)	d (mm)	D (mm)
TALP190-2		18.7	18.7	4	4.4	5.7
TALP191-2		18.7	18.7	4	4.4	5.7
TALP270-2		26.5	26.5	5.8	4.3	8.1
TALP271-2		26.5	26.5	5.8	4.3	8.1

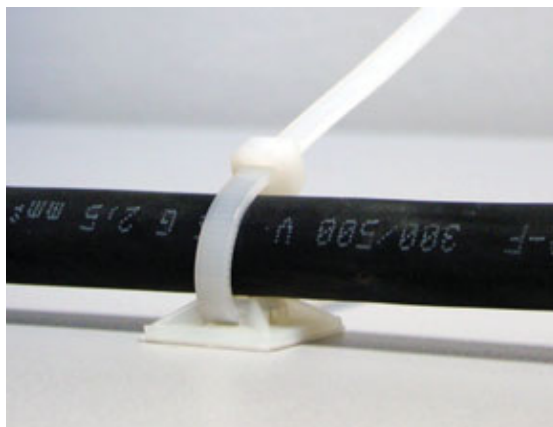
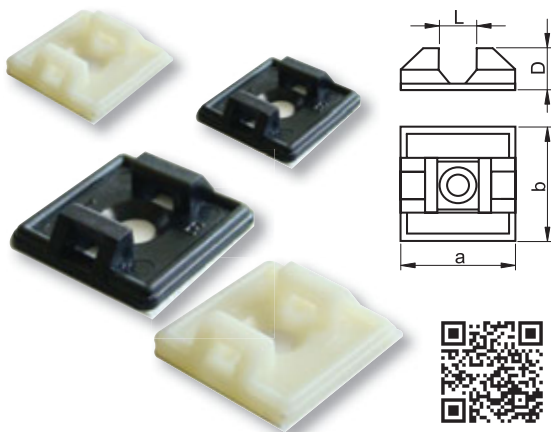

## Štvorvstupové samolepiace pätky k sťahovacím páskam



TRACON		a (mm)	b (mm)	L (mm)	d (mm)	D (mm)
TALP190		20	20	5	2.9	6.1
TALP191		20	20	5	2.9	6.1
TALP270		25	25	6.2	3.5	7.5
TALP271		25	25	6.2	3.5	7.5

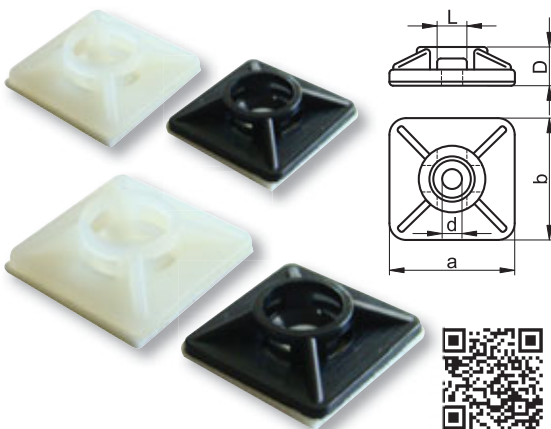

## Zatláčacie hmoždinky k sťahovacím páskam

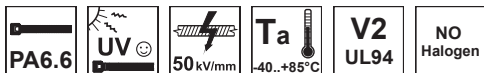

TRACON			a (mm)	b (mm)	c (mm)	W <sub>1</sub> (mm)	W <sub>2</sub> (mm)	L (mm)	D (mm)
5458		8 mm	10.6	6.3	3.1	12.8	12.6	43.8	9.9
5458N		8 mm	6.4	6.5	2.2	9.8	9.2	35.7	7.7

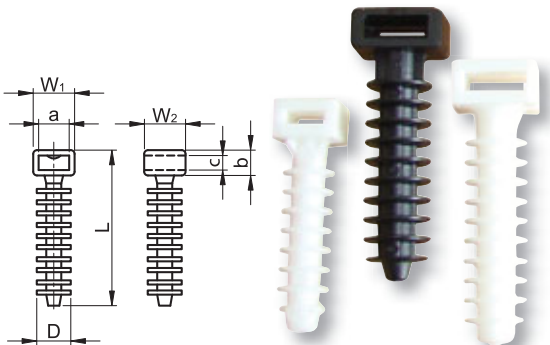
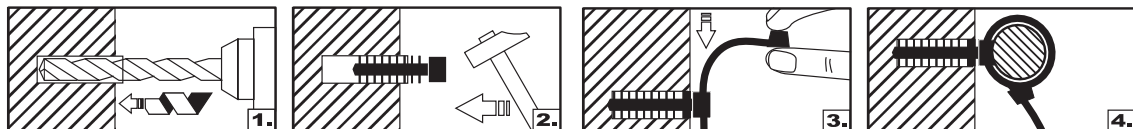

## Zatláčacie príchytky so sťahovacou páskou

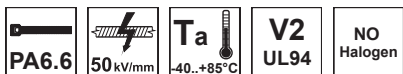

TRACON				A (mm)	B (mm)	D (mm)		
TBK-3		RAL 7035	180 × 7.5 mm	16-32 mm	17.6	24.5	5.9	150 N
TBK-4		RAL 7035	280 × 7.5 mm	40-63 mm	17.6	40.5	5.9	150 N

TRACON		
TBKT		6-7 mm

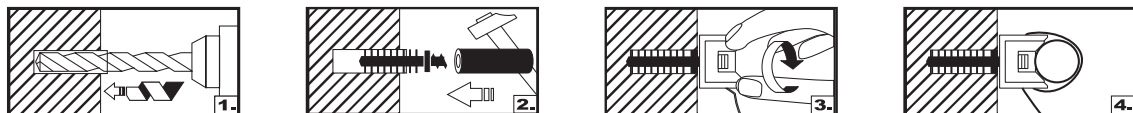
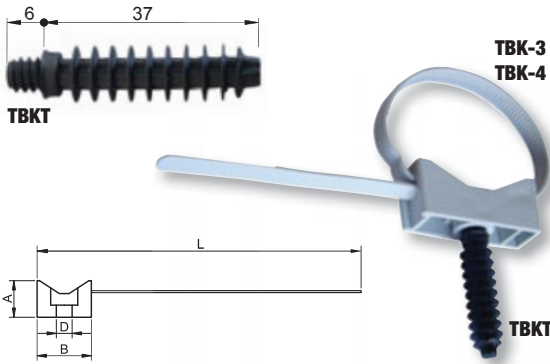

## Príchytky na káble, s klincom

TRACON			a (mm)	b (mm)
100 pcs	20 pcs			
NOF	NOF-20		2.5	4.5
N1	N1-20		6	7.3
N2	N2-20		8	8.1
N3	N3-20		9	8.3
N4	N4-20		11	10







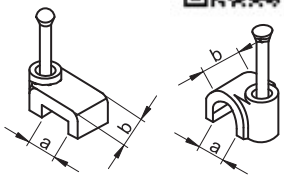





## Samoupínacie príchytky







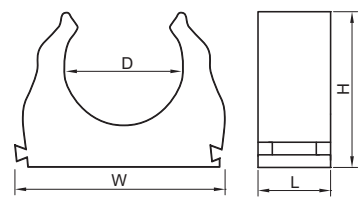

**Vysvetlivky piktogramov**
**C/O**

TRACON		D (mm)	W (mm)	L (mm)	H (mm)	
CSS-16		16	29.3	12.9	21.7	3/8" (coll)
CSS-20		20	33	12.9	24.2	1/2" (coll)
CSS-25		25	37.5	12.9	27.9	3/4" (coll)



## Samolepiace klipsy





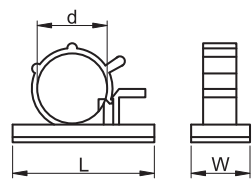
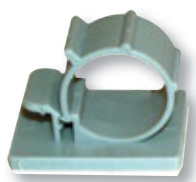

**Vysvetlivky piktogramov**
**C/O**

TRACON		d (mm)	W (mm)	L (mm)
TKCR-0708		7-8	20	25

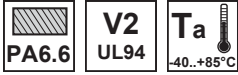

## Rozpínacie káblové príchytky



TRACON		d (mm)	L (mm)	H (mm)
TKCRZ-12		12	28	24.5
TKCRZ-15		15	28	28.5
TKCRZ-18		18	28	33
TKCRZ-20		20	28	34
TKCRZ-22		22	34	37
TKCRZ-28		28	38,5	45
TKCRZ-32		32	38	47.5
TKCRZ-35		35	41	49



## Umelohmotné káblové príchytky



TRACON		a (mm)	b (mm)	L (mm)	I (mm)	H (mm)	W (mm)
BCSV-3		10-18	18.6	26.4	16.2	19.8-37.5	17.7
BCSV-4		19-31	28.8	39.4	15.1	39.5-51.6	18.2

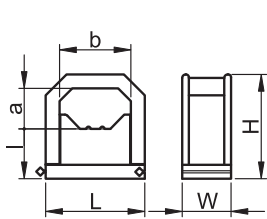

## Hmoždinky na uchytenie káblov



TRACON		d <sub>1</sub> (mm)	d <sub>2</sub> (mm)	B (mm)	L (mm)
KRT		6	6	10	36.5
KRT8		8	7.7	12.2	42.7

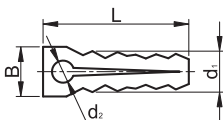



### Hmoždinky s profilovými skrutkami



V2  
UL94



TRACON		D × L (mm)	d (mm)	l <sub>1</sub> (mm)	l <sub>2</sub> (mm)	B (mm)
T6H		6 × 30	3.3	37	24.2	15.4
T6K		6 × 30	3.3	38.5	10	13.4

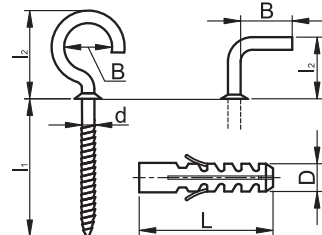

### Hmoždinky lemované, so šesťhrannou skrutkou



V2  
UL94



TRACON	D × L (mm)	d × l (mm)
T10080P	10 × 80	6.8 × 95
T10100P	10 × 100	6.8 × 115
T10120P	10 × 120	6.8 × 135
T10140P	10 × 140	6.8 × 155
T10160P	10 × 160	6.8 × 175
T10200P	10 × 200	6.8 × 215
T10240P	10 × 240	6.8 × 255
T10300P	10 × 300	6.8 × 315

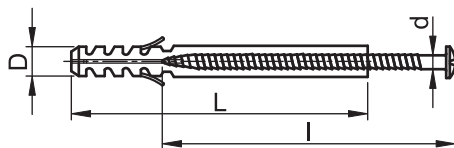

## Hmoždinky s vysokou zaťažiteľnosťou



TRACON	D × L (mm)	d × l (mm)*
T5-UNI	5 × 25	3.5 × 35
T6-UNI	6 × 30	4 × 40
T8-UNI	8 × 40	5 × 50
T10-UNI	10 × 50	6 × 60

\* Rozmery odporúčanej skrutky



Jedinečné vyhotovenie vnútra, s vynikajúcim uložením použitej skrutky.

Krídlička proti otočeniu, ktoré fixujú hmoždinku v každom type muriva, ako aj v mäkkých materiáloch.

Ryhovanie pod hlavou zvyšuje bezpečné zafixovanie hmoždinky v každom materiáli.

Hmoždinka sa doťahovaním skrutky skracuje a plášť sa v dutých materiáloch rozširuje, čo umožňuje vynikajúce fixovanie.

Rozširovanie do 4 strán umožňuje použiteľnosť v murive ľubovoľného typu a materiálu.

Zosilnený hrot hmoždinky zabezpečuje vhodné vedenie skrutky pri montáži.



Betón



Duté murivo

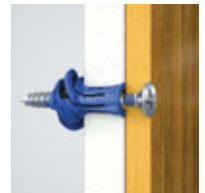

Stavebná doska

## Hmoždinky do sádrokartónu



TRACON	Popis	D × L (mm)	d × l (mm)*
GBT	Hmoždinka skrutkovacia do sádrokartónu	16 × 36	4 × 35
GSZT	Hmoždinka s krídičkami do sádrokartónu	10 × 55	4 × 50

\* Rozmery odporúčanej skrutky

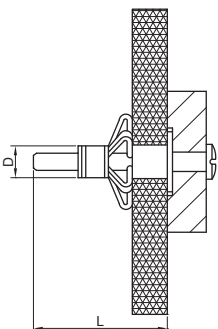

GSZT

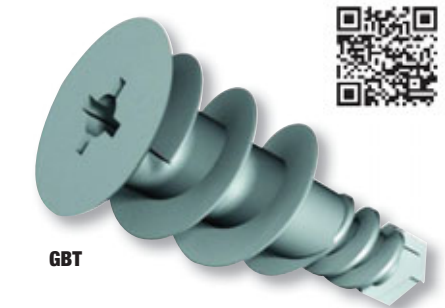

GBT

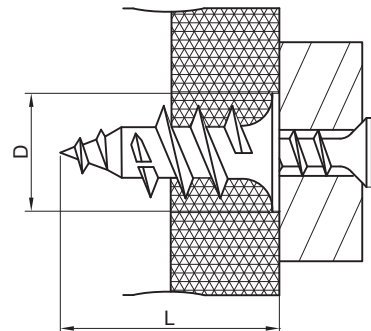

## Hmoždinky štvorhranné



V2  
UL94

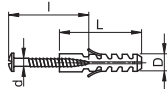

Vysvetlivky  
piktogramov

C/O



TRACON		D x L (mm)	d x l (mm)
<b>TN6</b>	<b>TNCS6</b>	6 x 23	2.6 x 30
<b>TN8</b>	<b>TNCS8</b>	8 x 34	3.5 x 38
<b>TN10</b>	<b>TNCS10</b>	10 x 42	4.4 x 46
<b>TN12</b>	<b>TNCS12</b>	12 x 52	5.4 x 61
<b>TN14</b>	-	14 x 65	-



## Hmoždinky so zatíkovou skrutkou



V2  
UL94

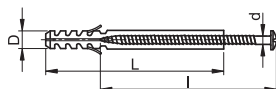

TRACON		D x L (mm)	d x l (mm)	TRACON		D x L (mm)	d x l (mm)
<b>TB525</b>		5 x 25	3.5 x 29	<b>TB845</b>		8 x 45	4.9 x 48
<b>TB535</b>		5 x 30	3.5 x 38	<b>TB860</b>		8 x 60	4.4 x 60
<b>TB545</b>		5 x 50	3.5 x 47	<b>TB875</b>		8 x 80	4.7 x 78
<b>TB635</b>		6 x 35	3.7 x 39	<b>TB8100</b>		8 x 100	4.7 x 102
<b>TB645</b>		6 x 40	3.7 x 48	<b>TB8120</b>		8 x 120	4.4 x 122
<b>TB655</b>		6 x 55	3.7 x 58	<b>TB8135</b>		8 x 135	4.4 x 137
<b>TB670</b>		6 x 60	3.7 x 73				



## Hmoždinky dlhé, PA6.6



V2  
UL94

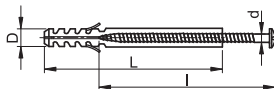

TRACON		D x L (mm)	d x l (mm)
-	<b>THC8100</b>	8 x 100	5.3 x 104
<b>TH8100</b>	<b>THC8120</b>	8 x 120	5.5 x 126
<b>TH8120</b>	<b>THC8135</b>	8 x 135	5.4 x 134
<b>TH1080</b>	<b>THC1080</b>	10 x 80	6.8 x 85
<b>TH10100</b>	<b>THC10100</b>	10 x 100	6.8 x 105
<b>TH10115</b>	<b>THC10115</b>	10 x 115	6.8 x 119
<b>TH10135</b>	<b>THC10135</b>	10 x 135	6.8 x 141
<b>TH10160</b>	<b>THC10160</b>	10 x 160	7 x 165



## Hmoždinky klasické

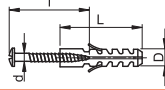

TRACON		D x L (mm)	d x l (mm)
<b>T6-PA</b>	<b>T6CS-PA</b>	6 x 30	4 x 40
<b>T8-PA</b>	<b>T8CS-PA</b>	8 x 40	5 x 50
<b>T10-PA</b>	<b>T10CS-PA</b>	10 x 50	5.5 x 60
<b>T12-PA</b>	-	12 x 60	-
<b>T14-PA</b>	-	14 x 75	-

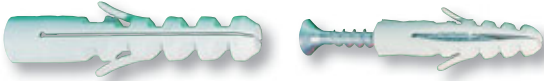

Vysvetlivky  
piktogramov **C/O**



## Hmoždinky lemované

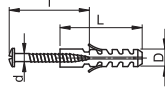

TRACON		D x L (mm)	d x l (mm)
-	<b>T6PCS-PA</b>	6 x 30	4 x 40
<b>T8P-PA</b>	<b>T8PCS-PA</b>	8 x 40	5 x 50
<b>T10P-PA</b>	<b>T10PCSPA</b>	10 x 50	5.5 x 60
<b>T12P-PA</b>	-	12 x 60	-



## Hmoždinky uzlovacie

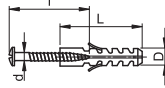

TRACON		D x L (mm)	d x l (mm)
<b>TOP6</b>	<b>TOPCS6</b>	6 x 40	4 x 50
<b>TOP8</b>	<b>TOPCS8</b>	8 x 50	5 x 60
<b>TOP10</b>	<b>TOPCS10</b>	10 x 60	6 x 70



## NAČITAJTE KÓD!

- Pozrite si naše novinky!
- Buďte informovaný!

Náš sortiment sa neustále a rýchlo rozrastá.  
Predložený katalóg odráža stav k aprílu 2019.  
Pre aktuálne informácie, prosím,  
navštívte našu internetovú stránku!



## Sklápacie závesy do dutých priestorov

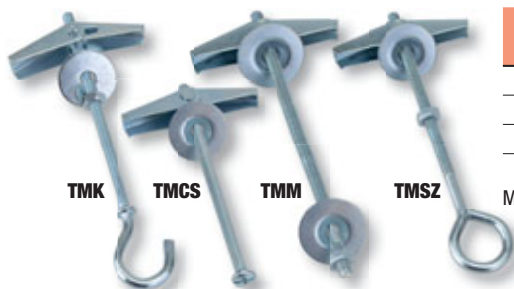

TMK

TMCS

TMM

TMSZ

TRACON	d (mm)	L (mm)	a (mm)	B (mm)	
TMK	M4	95	20	14	200 N
TMCS	M4	81	20	-	800 N
TMM	M4	100	20	-	800 N
TMSZ	M4	93	20	14	200 N

Materiál: oceľ, pozinkovaná.

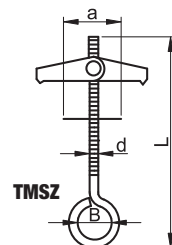
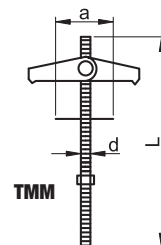
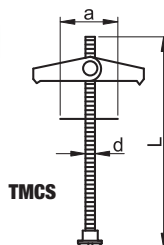
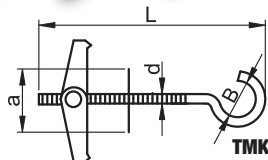

## Lanové očnice

TRACON	W (mm)	l (mm)	L (mm)	c (mm)	s (mm)	
SZIV-3	4.5	41.6	46.3	17	1	1 – 3 mm
SZIV-4	5.5	37.7	41.7	15	1	3 – 4 mm
SZIV-5	6.2	37.8	42.4	15	1	4 – 5 mm
SZIV-6	9	42.8	47.5	18.1	1	5 – 6 mm
SZIV-8	9.4	47.7	54.5	19.2	1.5	6 – 7 mm
SZIV-10	12.1	53.8	59.7	21.9	1.5	7 – 9 mm
SZIV-12	17.1	62.4	68.5	28.8	1.5	9 – 12 mm
SZIV-16	21.1	75.7	82.9	39.2	2	12 – 14 mm
SZIV-19	21.6	80.6	90.3	42.2	2.3	16 – 19 mm

Materiál: oceľ, pozinkovaná.

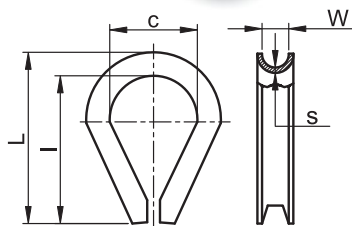

## Háky "S"

TRACON	d (mm)	L (mm)	l (mm)	m (mm)	D (mm)	
HR3-25	3	26	20.2	3	7	320 N
HR3-30	3	31.1	25.5	4.8	8.8	320 N
HR4-30	4	33.4	25.5	4.8	10	575 N
HR4-35	4	35.3	27.5	5.2	10.2	575 N
HR4-40	4	41	33.3	5.9	10.9	575 N
HR5-45	4.8	46	36.7	6.6	12.5	730 N
HR5-50	5	53.5	44	10.3	15.3	885 N
HR6-80	6	80	69	12	24	1250 N
HR8-100	8	104	88	17	31	2000 N

Materiál: oceľ, pozinkovaná.

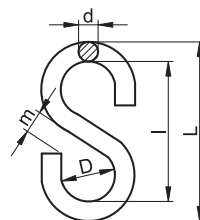

## Lanové svorky, profil "U"

TRACON	d (mm)	D (mm)	W (mm)	H (mm)	h (mm)	L (mm)	 mm
U03	M4	5.4	9.5	20.4	7.3	18	2-3 mm
U05	M5	7.2	9.6	24.2	7.5	21.5	3.2-5 mm
U06	M5	8.0	11.2	24.2	9.5	23.8	4.5-7 mm
U08	M6	9	12.9	35.4	10.4	27.4	6.3-8 mm
U09	M8	10.5	16.6	37.3	12.7	33	8-9 mm
U11	M8	11	18.4	41	16	36.4	10-11 mm
U13	M10	14.8	20.6	54.7	18.7	42.2	12-14 mm
U14	M10	14.9	24.2	55.2	23	43.7	12-14 mm
U16	M10	18.2	26	62	25.2	49.9	14-16 mm
U19	M12	21.5	29.7	76.8	30.2	54.4	16-19 mm
U22	M12	21.5	31	77.8	33.2	56.7	19-22 mm
U25	M14	27.7	32.8	95.7	34.5	63.3	22-25 mm

Materiál: napínacia skrutka: oceľ, pozinkovaná. Telo svorky: temperovaná zliatina.

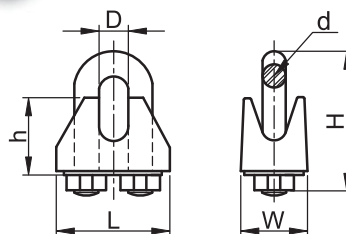

## Lanové svorky jednoskrutkové "simplex"

TRACON	d (mm)	b (mm)	B (mm)	H (mm)	L (mm)	k (mm)
BSZ1-2	M4	5.1	13.6	6.1	17.2	13
BSZ1-3	M4	6.4	15.3	7	18.4	13.6
BSZ1-4	M5	10	16.6	6.5	21	17.4
BSZ1-5	M5	10.4	18.7	8.9	24.4	16.9
BSZ1-6	M6	12.5	23.3	9.6	30.2	21.6
BSZ1-8	M8	18.6	30.4	13.5	36.5	29.2

Materiál: oceľ, pozinkovaná.

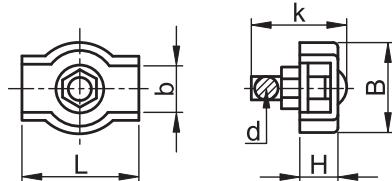

## Lanové svorky dvojskrutkové "duplex"

TRACON	d (mm)	b (mm)	B (mm)	H (mm)	L (mm)	k (mm)
BSZ2-2	M4	5.8	12.9	5	36.6	13.4
BSZ2-3	M4	6.4	15.3	6.7	35.2	13.5
BSZ2-4	M5	8.4	17.5	7.1	40	17.6
BSZ2-5	M5	11.9	20.4	8.8	48.8	19.6
BSZ2-6	M6	12.5	23.3	9.6	60.5	21.6
BSZ2-8	M8	18.6	30.4	13.5	73	29.2

Materiál: oceľ, pozinkovaná.

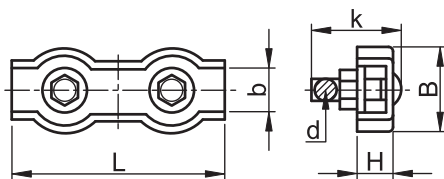

## Lanové svorky ploché "AMAX"

TRACON	d (mm)	W (mm)	H (mm)	L (mm)	k (mm)	
AMAX3	M3	16.1	10.2	28.6	12.7	3 mm (1/8")
AMAX5	M5	17.5	10.7	30.5	12.4	5 mm (3/16")
AMAX6	M6	22.9	12.9	34.9	15.9	6 mm (1/4")

Materiál: oceľ, pozinkovaná.

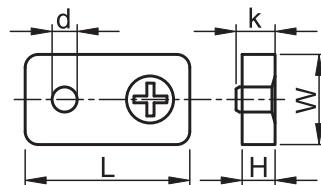

## Karabíny s pružinou

TRACON	d (mm)	D (mm)	W (mm)	L (mm)	m (mm)	
RKARA4	4.5	5.8	21.1	42.0	5.5	300 N
RKARA5	5	6.6	26	51.3	7.2	500 N
RKARA6	6	6.9	30.2	62.3	7.7	800 N
RKARA7	7	7.8	35.1	70.7	8.7	1100 N
RKARA8	8	8.1	40.4	80.5	10.2	1400 N
RKARA9	9	9.7	45	90.3	11.7	1700 N
RKARA10	10	11.1	47.3	99.8	13.4	2100 N
RKARA11	11	12.3	57.3	121.2	16.5	2500 N
RKARA12	12	13.9	63.2	142.5	20.8	2700 N
RKARA13	13	15.8	72.8	149.4	24.1	3000 N

Materiál: oceľ, pozinkovaná.

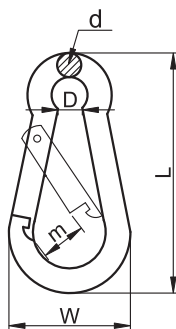

## Karabíny so skrutkou





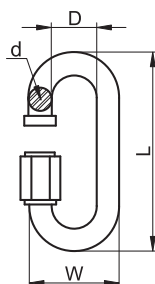























TRACON	d (mm)	D (mm)	W (mm)	L (mm)	
CSKARA3,5	3.5	10.8	17.9	35.5	420 N
CSKARA4	4	11.6	19.7	40.6	850 N
CSKARA5	5	13.6	23.5	50.9	1270 N
CSKARA6	6	14.7	26.7	58.3	1700 N
CSKARA7	7	18.4	32	68.2	2550 N
CSKARA8	8	19.6	36	73.8	3100 N
CSKARA9	9	20.6	39.2	82.2	4250 N
CSKARA10	10	21.6	42.4	89.6	5100 N
CSKARA12	12	23.5	48.3	106.2	6400 N

Materiál: oceľ, pozinkovaná.





## Napínacie skrutky

TRACON			d (mm)	l (mm)	L (mm)	d (mm)	
 FSS550	 FSH550	 FHH550	5	50	92.6	7.8	750 N
 FSS570	 FSH570	 FHH570	5	70	113	8	770 N
 FSS660	 FSH660	 FHH660	6	60	112	10	1050 N
 FSS6100	 FSH6100	 FHH6100	6	100	154	10.2	1800 N
 FSS870	 FSH870	 FHH870	8	70	137	12.3	1200 N
 FSS8110	 FSH8110	 FHH8110	8	110	176	12.3	2000 N
 FSS10120	 FSH10120	 FHH10120	10	120	194	13.3	3000 N
 FSS12130	 FSH12130	 FHH12130	12	130	224	18.3	4450 N
 FSS16130	 FSH16130	 FHH16130	16	140	265	22	5950 N

Skrutka: oceľ, pozinkovaná. Telo: temperovaná zliatina.

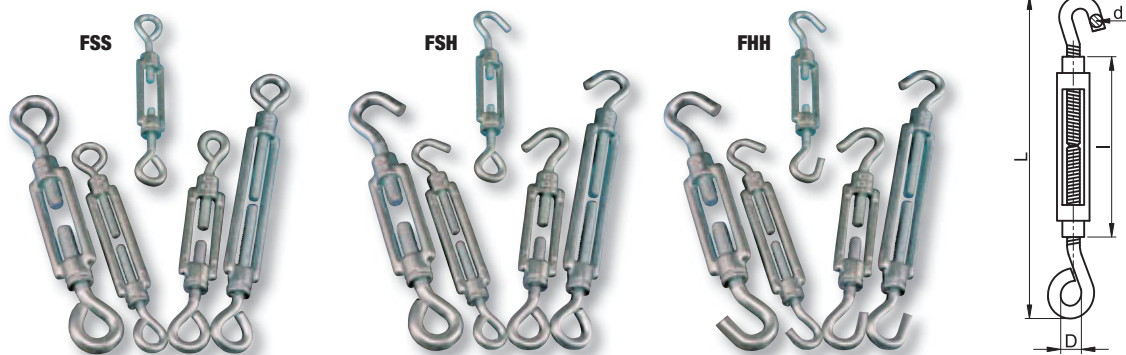

### NAČITAJTE KÓD!

- Pozrite si naše novinky!
- Buďte informovaný!

Náš sortiment sa neustále a rýchlo rozrastá.  
 Predložený katalóg odráža stav k aprílu 2019.  
 Pre aktuálne informácie, prosím,  
 navštívte našu internetovú stránku!

## Káblové zväzovacie špirály

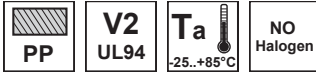

TRACON	d (mm)	D (mm)	s (mm)		
SPI6	6.2	8.6	1.9	1 m	6 mm
SPI8	8	10.9	2.4	1 m	8 mm
SPI10	10	13.2	2.9	1 m	10 mm
SPI12	12	15.4	2.9	1 m	12 mm
SPI15	15	17.1	2.9	1 m	15 mm
SPI20	20	24	3	1 m	20 mm
SPI25	25	28.7	3	1 m	25 mm

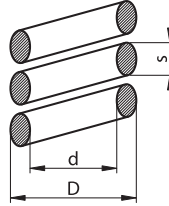

## Káblové zväzovacie špirály



TRACON		D (mm)	d (mm)	W (mm)		
KSPI-4N	KSPI-4F	4.5	3.2	6.8	10 m	4...20 mm
KSPI-6N	KSPI-6F	6.9	5.3	10.3	10 m	7...40 mm
KSPI-8N	KSPI-8F	8.4	6.6	11.7	10 m	12...50 mm
KSPI-10N	KSPI-10F	10.2	8.2	13.4	10 m	13...70 mm
KSPI-12N	KSPI-12F	12.2	9.6	15.9	10 m	15...80 mm
KSPI-16N	KSPI-16F	15.7	12.4	21.6	10 m	20...120 mm

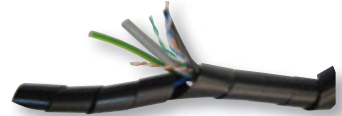
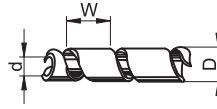

Vysvetlivky piktogramov **C/O**

## Plastové zväzovacie sieťky

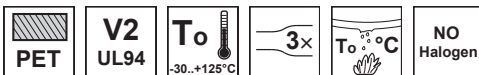

TRACON		
TKH-003	3 mm	2.4 – 6.4 mm
TKH-010	10 mm	4.8 – 15.9 mm
TKH-016	16 mm	9.5 – 25.4 mm
TKH-025	25 mm	15.9 – 36.1 mm
TKH-032	32 mm	19.1 – 44.5 mm



Umožňujú flexibilné uloženie a mechanickú ochranu káblov a vodičov v slabo- i silnoprúdových elektrických inštaláciách, v automobilovom priemysle. Rezanie na príslušnú dĺžku je účelné vykonávať horúcim nožom alebo špeciálnym spájkovacím hrotom. Otvorený systém zväzovania umožňuje dobrú ventiláciu a odvedenie tepla od povrchu vodičov.