























































Táblázat fejlécek piktogramjai

	Megjegyzés, kiegészítés		Fedélrögzítés: csavaros		I_n Névleges áram (A)		Szín
	Fedél: átlátszó	IP..	Védettségi fokozat		Villamos szilárdság		Bemenet
	Szerelősín: perforált		Szerelősín: teli		Beköthető vezeték-keresztmetszet mm ²		Beköthető vezeték Ø mm
	X Csavarok száma		M Menet		xP Pólusszám		x17.5 Modulok száma
	Tömör, sodrott, hajlékony vezeték		pcs Csomagolás		Sorolósín - Csapos kivitel		Sorolósín - Villás kivitel
	X Kapcsok száma		Tömítési tartomány		Főkábel		Leágazó oldal
	Sín keresztmetszet mm ²		Maximális terhelhetőség		Ajánlott terhelhetőség		Sín méret (mm)
	Mechanikailag terhelt nullavezető		CLICK Fedélrögzítés: pattintható		Fedél: teli		

Műszaki adatok piktogramjai

	230/400 V AC Névleges feszültség (V)		U_i Névleges szigetelési feszültség 660 V		ABS Anyag: ABS		PA6.6 Anyag: Poliamid 6.6
	PE Anyag: Polietilén		PP Anyag: Polipropilén		Cu Anyag: Sárgaréz		PVC Anyag: PVC
	Szerelősínre szerelhető 35x7.5		T_a Környezeti hőmérséklet -10..+55 °C		R Ellenállás 10 ¹⁴ Ωcm		Cu Rézsín
	F_t (N) Tapadóképesség 1.8 N/cm		ΔL Szakadási nyúlás 500 %		F_{sz} Szakítóerő, szakítószilárdság 150 N/cm		Villamos szilárdság 40 kV/mm
	T_o Üzemi hőmérséklet -0..+90 °C		I_n max. Névleges áram (A) 100 A		IP 68 Védettségi fokozat		Zárópecsételhető
	Gumidugóval		PS Anyag: Polisztirol		Silicon free Szilikon mentes		IK10 Ütésállóság
	Szín RAL 7035						



Szigetelőszalagok **2**



Ön vulkanizáló, szigetelő szalagok **3**



Vászon szigetelő szalag **3**



Ipari padlójelölő szalag **3**



Maszkolószalag **4**



Csúszást csökkentő jelölőszalag, sárga-fekete **4**



Jelölőplomba **5**



Mérőóra plomba **5**



Tömítő szelencés kábeltoldó **6**



MG Metrikus tömítőszelencék **8**



MG fémből készült metrikus tömítőszelencék **8**



Metrikus tömítőszelence törésgátló kábelbevezetővel **9**



Gégecsőhöz illeszkedő kiegészítő gyorscsatlakozó **11**



Öntapadós jelzőcímkék **12**

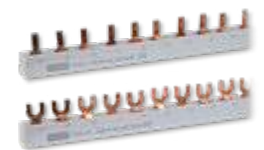

Sorolósínek 125 A-ig **13**

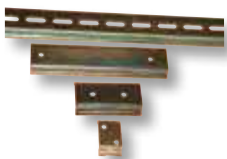

Szerelősínek **14**



Rézintartó bakok **14**



Rézsin (N/PE sín) **14**

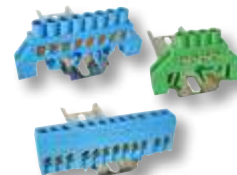

Szigetelt földelő sín **15**



Falon kívüli kötődobozok **16**



Elektronikai doboz **17**



Műanyag doboz **18**



Műanyag szerelődobozok **19**



Falon kívüli rugalmas kötődobozok **19**



Gipszkarton dobozok **19**



Süllyesztett perforált kötődobozok **20**



Süllyesztett perforált szerelvénydobozok **20**



Dobozfedelek **21**



Univerzális szerelvénydoboz **21**



Doboztoldás utólagos szigeteléshez **21**



Feszítő szerelvények **22**



Függesztő szerelvények **22**



Csavaros kötőelemek **23**



LTT Légvezeték-távtartó **23**



TB Tetőtartó bevezető **23**

Szigetelőszalagok

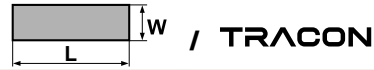
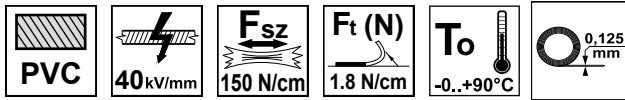

	10 m × 15 mm	10 m × 18 mm	20 m × 18 mm	20 m × 50 mm
	B10-15	B10	B20	-
	FEH10-15	FEH10	FEH20	FEH50
	FEK10-15	FEK10	FEK20	FEK50
	K10-15	K10	K20	K50
	-	L10	L20	-
	-	N10	N20	-
	P10-15	P10	P20	P50
	S10-15	S10	S20	S50
	SZ10-15	SZ10	SZ20	SZ50
	Z10-15	Z10	Z20	Z50
	ZS10-15	ZS10	ZS20	ZS50



RELEVANT STANDARD
EN 60454



TÜV MEEI TEST DOCUMENTATION
28207724 001

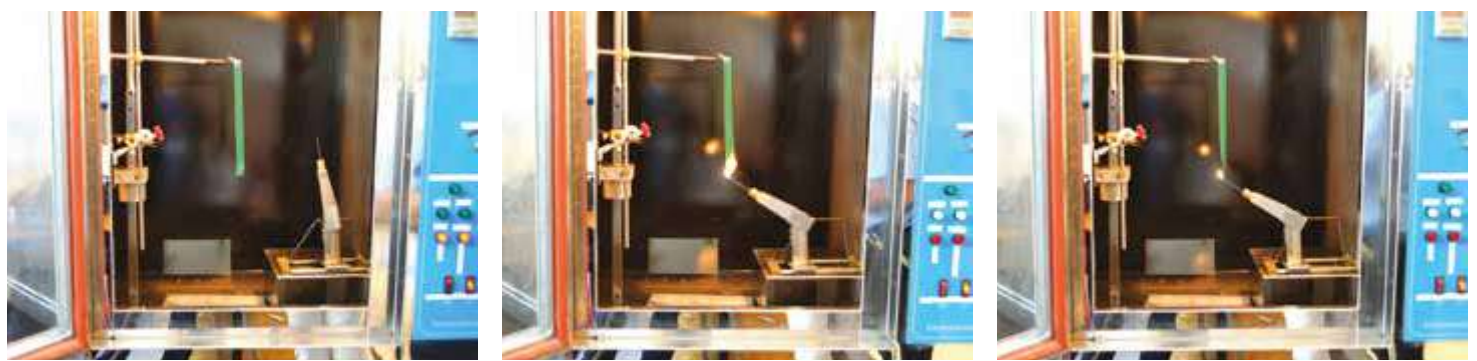

Az Izzóhuzalos és a Tűlángos vizsgáló berendezésekkel műanyag termékeink tűzveszélyességét vizsgáljuk.



Ön vulkanizáló, szigetelő szalagok

TRACON		
ONVSZ19	10 m × 19 mm	0,5±0,05 mm
ONVSZ25	10 m × 25 mm	0,5±0,05 mm
ONVSZ38	10 m × 38 mm	0,5±0,05 mm





Fekete színű, összeragadás ellen műanyag filmmel elválasztott, éghető, poli-izobutilén szalagok.

Főbb felhasználási területei: elsősorban gyengeáramú, valamint kábel televíziós vezetékek és telefon kábelek kötése, csővezetékek korrózió védelme, erősáramú kis- és közép feszültségű kábelek szerelése 36 kV-ig, de ez utóbbi – az éghetőség miatt – csak hőhatásnak nem kitett esetekben.

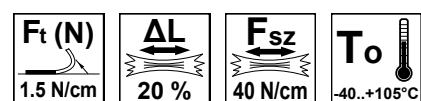

Vászon szigetelő szalag



TRACON		
TVSZ25	25 m × 25 mm	0,3 mm





Fekete PE extrudált szövetszalag.

Alapja 55 szemes szőtt PET/műselyem szövet hordozó, amelyet nyomásérzékeny természetes gumiragasztóval vontak be.

Speciális szövetszalag





TRACON		
SV50	50 m × 50 mm	0,15 mm



Nagy tapadóerővel az ipar minden területe számára. Alkalmos rögzítésre, jelölésre, kötegelésre.

Ipari padlójelölő szalag



TRACON		
BY50	33 m × 50 mm	0,15 mm



Üzemcsarnokok, raktárak közlekedési útvonalainak és veszélyes helyeinek kijelölésére, közismert nevén útvonaljelölő szalag.

Kétoldalú ragasztószalag



TRACON



KOR50	25 m × 50 mm
KOHR10*	25 m × 10 mm
KOHR24*	25 m × 24 mm

* habosított



Maszkolószalag



TRACON



MSZ18	35 m × 18 mm
MSZ24	35 m × 24 mm
MSZ36	35 m × 36 mm
MSZ48	35 m × 48 mm



Csúszást csökkentő szalag, fekete



TRACON

H
(mm)

SRTB25	5 m × 25 mm	0,75 mm
SRTB50	5 m × 50 mm	0,75 mm



Csúszást csökkentő jelölőszalag, sárga-fekete

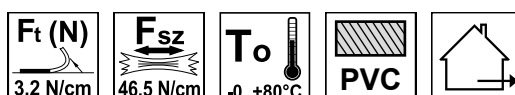



TRACON

H
(mm)

SRTYB25	5 m × 25 mm	0,75 mm
SRTYB50	5 m × 50 mm	0,75 mm

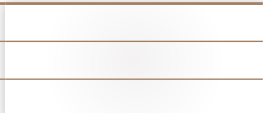
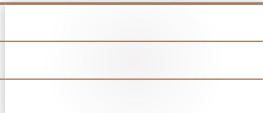
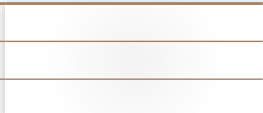

Jelölőplomba

TRACON		L (mm)	a (mm)	b (mm)	
JPL1		230	18	54	80 N
JPL2		330	18	54	80 N
JPL3		415	21	79	200 N

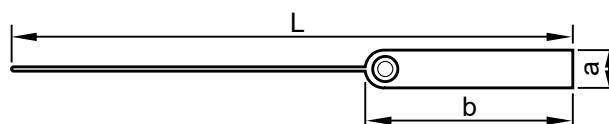



Jelöléstechnikai eszköz, amely egyediségével (egyedi sorszám) ellenőrizhetővé, nyomónkövethetővé teszi a védett tárgyhoz való hozzáférést. A plombák felhelyezése és levétele igen egyszerű, nem igényel szerszámokat, segédanyagot. Műanyag plombáink feje fém- vagy kemény műanyag betétesek, így hőre nem lágyulnak, a plombák szétnyitása roncsolás nélkül lehetetlen.



Mérőóra plomba



TRACON		a (mm)	b (mm)
MP1		30,5	21
MP2		27	13

Mérőóra plombáink alkalmasak elosztószekrények, gázórák és egyéb mérőórák jelképes védelmének ellátására. Ajánljuk minden olyan helyre, ahol szimbolikus zárás a cél, de nem szeretnénk, hogy a plomba idő előtt leszakadjon. Felhelyezéséhez nem szükséges szerszám vagy segédanyag. Fémsodronyszál hossza 25 cm.

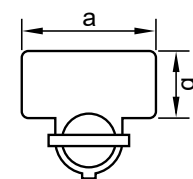
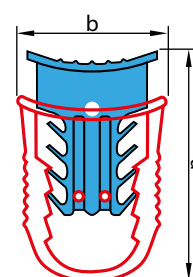

Kínálatunk gyorsan és folyamatosan fejlődik!
Katalógusunk a 2024. szeptemberi állapotot tükrözi.
Naprakész információkért
látogasson el honlapunkra!



OLVASSA BE A KÓDOT!

- Nézze meg újdonságainkat
- Legyen naprakész



Tömítőszelencés kábeltoldó



TRACON	mm ²			xP 	L (mm)	D (mm)	U _n	I _n	IP..
	In	Out							
CST1	0.5-1	0.5-1	PG9	3	68	21	250 VAC	13 A	IP 65
CST4	0.5-4	0.5-4	MG25	5	123	33	450 VAC	24 A	IP 68
CST4-T	0.5-4	0.5-2.5 (4)	MG25	5	110	33	450 VAC	24 A	IP 68
CST4-T3P	2,5 (4)	2,5 (4)	MG25	3	110	33	450 VAC	24 A	IP 68
CST4-Y	0.5-4	0.5-2.5 (4)	MG25	5	150	33	450 VAC	24 A	IP 68
CST4-Y3P	2.5 (4)	2.5 (4)	MG25	3	150	33	450 VAC	24 A	IP 68
CST15B	0.5-1.5	0.5-1.5	MG20	3	90	27	450 VAC	16 A	IP 68
CST15W	0.5-1.5	0.5-1.5	MG20	3	74	26	450 VAC	16 A	IP 68
CST25	0.5-2.5	0.5-2.5	MG20	3	74	26	250 VAC	16 A	IP 65
CST25F	0.5-2.5	0.5-2.5	MG20	3	107	29	250 VAC	16 A	IP 68
CSTBOX	0.5-1	0.5-1	PG9	3	116	–	250 VAC	13 A	IP 65



PG tömítőszelencék

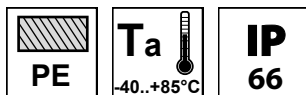

TRACON		T (mm)	B (mm)	d (mm)	D (mm)	L ₁ (mm)	L ₂ (mm)
PG-7	3.5 - 6.5	16	18	6	12	10	22
PG-9	4.5 - 7	19	22	8	15	10	25
PG-11	5.5 - 10	22	23	10	18	8	29
PG-13,5	9 - 13	23	26	13	20	10	29
PG-16	10 - 14	26	29	14	21	9	29
PG-21	14 - 18	32	35	19	28	12	35
PG-29	18 - 25	41	45	26	36	12	40
PG-36	25 - 30	52	58	31	46	12	45
PG-42	30 - 38	57	56	37	51	14	40
PG-48	37 - 44	65	71	43	58	21	50

Membrános gumitömítés PG tömítőszelencéhez

TRACON	
PG7-G	3,5-6
PG9-G	7,5-8,5
PG11-G	7-9,5
PG13,5-G	9-12
PG16-G	11-14
PG21-G	14-17,5
PG29-G	22-25
PG36-G	26-33
PG42-G	31-37
PG48-G	37-43

Rögzítő menet: páncélcső

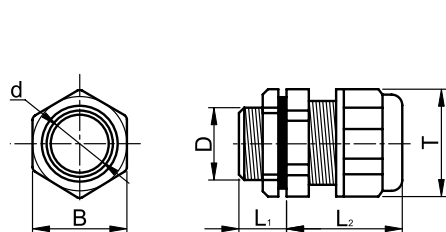

PG.-G



PG fémből készült tömítőszelencék

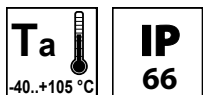

TRACON		T (mm)	B (mm)	d (mm)	D (mm)	L ₁ (mm)	L ₂ (mm)
PGF-7	2 - 5	16	14	7.4	12.5	7	15
PGF-9	3-6.5	19	17	8.8	15	8	17
PGF-11	4-8	22	20	10.7	18.5	8	17
PGF-13,5	5-10	24.2	22	12.7	20	8	19
PGF-16	6-12	26.5	24	14.6	22.4	8	20
PGF-21	12-16	33	30	18.6	28.2	9	22
PGF-29	14-21	44	40	25.7	36.8	10	25
PGF-36	23-30	55	50	33.6	46.8	11	28
PGF-42	30-35	63	57	39.5	53.8	13	30
PGF-48	35-40	70	64	44.7	59	14	32

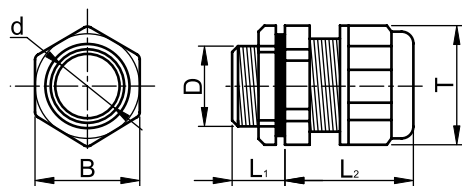

Rögzítő menet: páncélcső
Anyag: réz (nikkelezve)

RELEVANT STANDARD
MSZ EN 62444



MG Metrikus tömítőszelencék

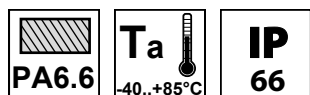

TRACON			T (mm)	B (mm)	d (mm)	D (mm)	L ₁ (mm)	L ₂ (mm)
MG-12	MG-12F	3.5 - 7.5	18.3	17.3	7.6	M12	9	27
MG-16	MG-16F	5 - 10	22	21.7	10.6	M16	15	30
MG-20	MG-20F	6.5 - 14	29.5	27	14.5	M20	14	37
MG-25	MG-25F	12 - 18	32.6	32.6	18	M25	14	37
MG-32	MG-32F	15 - 24	40.6	40.5	26	M32	15	42
MG-40	MG-40F	21 - 30	49.4	48.9	30.8	M40	20	46
MG-50	MG-50F	30 - 40	62.1	60.6	40.6	M50	22.5	54
MG-63	MG-63F	40 - 50	81	76	52.5	M63	23.8	57

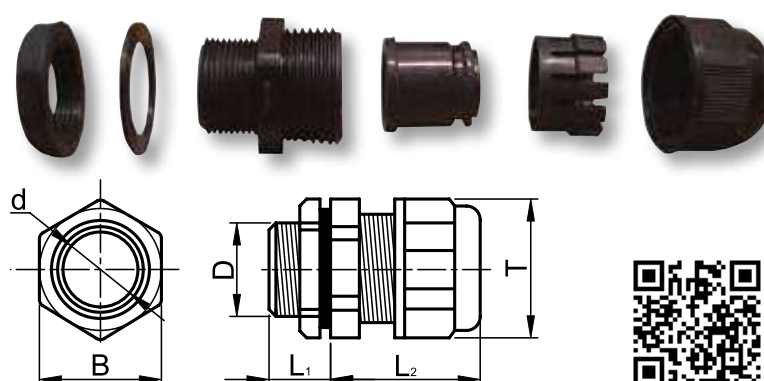

RELEVANT STANDARD
MSZ EN 62444

MG fémből készült metrikus tömítőszelencék

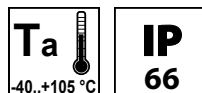

TRACON			T (mm)	B (mm)	d (mm)	D (mm)	L ₁ (mm)	L ₂ (mm)
MGF-12		3-6.5	15.5	14	7.5	M12 × 1.5	6.5	15
MGF-16		4-8	20	18	9	M16 × 1.5	8	16
MGF-18		5-10	22	20	10.6	M18 × 1.5	8	17
MGF-20		6-12	24	22	12.7	M20 × 1.5	8	19
MGF-25		8-14	26.5	24	14.6	M25 × 1.5	9	19
MGF-32		15-22	38	35	22.8	M32 × 1.5	10	23
MGF-40		18-25	43.8	40	25.6	M40 × 1.5	11	25
MGF-50		32-38	63	57	39.4	M50 × 1.5	13	30
MGF-63		37-44	70	64	44.8	M63 × 1.5	14	31

Anyag: réz (krómozva)

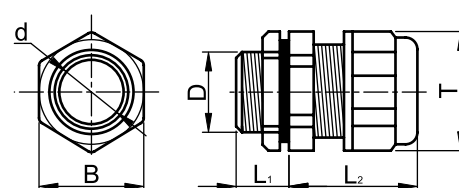

RELEVANT STANDARD
MSZ EN 62444



Metrikus tömítőszelence törésgátló kábelbevezetővel



TRACON	mm	D ₁ (mm)	D ₂ (mm)	B ₁ (mm)	L ₁ (mm)	L ₂ (mm)	L ₃ (mm)
MG-12TG	3 - 6.5	M12 × 1.25	8.3	6	7.9	12.1	53.3
MG-16TG	5 - 10	M16 × 1.5	10.9	9.6	14.4	14.4	74.9
MG-20TG	10 - 14	M20 × 1.5	14.8	12.9	12.8	19.5	96.2
MG-25TG	13 - 18	M25 × 1.5	18.5	16.5	13.9	19.5	111.2

Törésgátló spirállal egybeépített tömítőszelencéket alkalmazhatunk hajlékony kábeleknél és minden olyan esetben és helyen, ahol fontos a nagy megbízhatóság és a kábel törés elleni védelme.



RELEVANT STANDARD
MSZ EN 62444

RELEVANT STANDARD
EN 60423

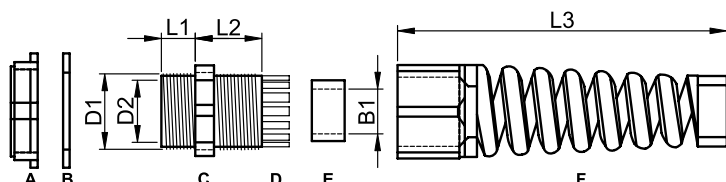

A – Rögzítőanya
B – Alátét gyűrű

C – Test
D – Köröm

E – Tömítés
F – Szorítóanya a törésgátló spirállal



Metrikus szűkítő közcsavar



TRACON	D ₂ (mm)	D ₁ (mm)	L (mm)	W (mm)
TMSZ-20/12	M20 × 1.5	M12 × 1.5	8	24.2
TMSZ-20/16	M20 × 1.5	M16 × 1.5	8	24.2
TMSZ-25/16	M25 × 1.5	M16 × 1.5	8	29
TMSZ-25/20	M25 × 1.5	M20 × 1.5	8	29
TMSZ-32/20	M32 × 1.5	M20 × 1.5	10	35.9
TMSZ-32/25	M32 × 1.5	M25 × 1.5	10	35.9
TMSZ-40/32	M40 × 1.5	M32 × 1.5	10	45.8
TMSZ-50/40	M50 × 1.5	M40 × 1.5	11.5	55
TMSZ-63/50	M63 × 1.5	M50 × 1.5	11.5	67.5

Az alkalmazni kívánt tömítőszelence méreténél nagyobb furatátmérővel rendelkező kábelátvezetés leszűkítésére használhatjuk. A közcsavarhoz rögzítőanya rendelhető, lásd következő oldal!

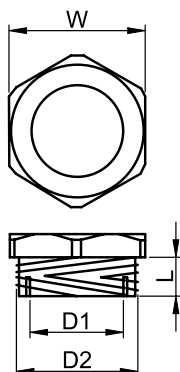

RELEVANT STANDARD
EN 60423

Metrikus rögzítőanyag

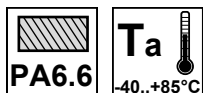

TRACON		d (mm)	B (mm)	H (mm)
MG-12-A	MG12	M12 × 1.5	17.5	5
MG-16-A	MG16	M16 × 1.5	22	7
MG-20-A	MG20	M20 × 1.5	26.5	7.5
MG-25-A	MG25	M25 × 1.5	33	8
MG-32-A	MG32	M32 × 1.5	40.5	8
MG-40-A	MG40	M40 × 1.5	49	10
MG-50-A	MG50	M50 × 1.5	60.5	9.5
MG-63-A	MG63	M63 × 1.5	73.5	11



Alkalmazható metrikus tömítőszelencék, szűrítő közcsavar és záródugók kivágási furatokban való rögzítésére.



RELEVANT STANDARD
EN 60423

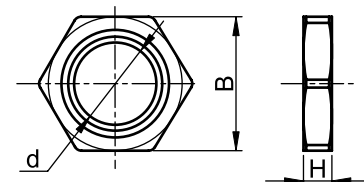

Metrikus záródugó

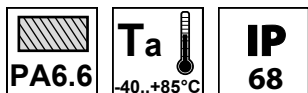

TRACON	A (mm)	B (mm)	C (mm)	D (mm)
TMZ-12	M12 × 1.5	15	10	6
TMZ-16	M16 × 1.5	20	10.5	6
TMZ-20	M20 × 1.5	24	10.5	6
TMZ-25	M25 × 1.5	29.7	12.8	7.8
TMZ-32	M32 × 1.5	36.6	13.3	7.8
TMZ-40	M40 × 1.5	45.8	13.4	7.8
TMZ-50	M50 × 1.5	55.5	16.2	9.8
TMZ-63	M63 × 1.5	69.3	17.5	11.8



Általánosan felhasználható kábelátvezetések lezárására. A záródugóhoz rögzítőanya rendelhető.



RELEVANT STANDARD
EN 60423

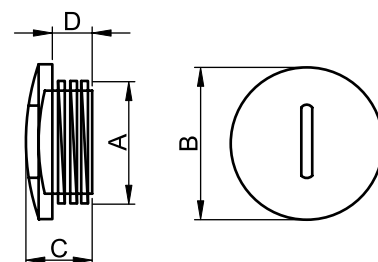

Gégecsőhöz illeszkedő kiegészítő gyorscsatlakozó

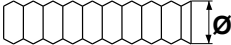

TRACON	D ₁ (mm)	D ₂ (mm)	D ₃ (mm)	L ₁ (mm)	L ₂ (mm)	L ₃ (mm)	
GCS-16	15,9	11	10,8	10	17,9	15,7	16 mm
GCS-20	19,2	15	14,7	10	17,7	16	20 mm
GCS-25	25	18,9	19,8	11,4	23,6	20,6	25 mm
GCS-32	31,2	26	24,3	12	22,8	20,6	32 mm
GCS-40	37,5	31,5	31,6	11,3	23,6	20,7	40 mm
GCS-50	44	37,5	39,5	12,6	21,6	20,7	50 mm

Alkalmazható gégecsövek elosztó- kötődobozokhoz, szekrényekhez való csatlakoztatására.



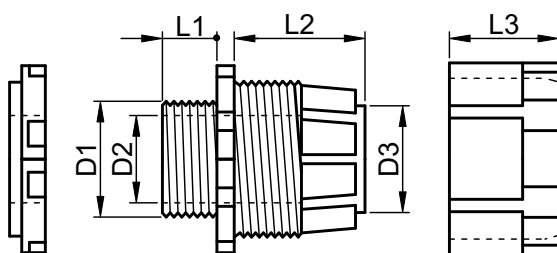

RELEVANT STANDARD
MSZ EN 62444



Kábelátvezető (nyitott-zárt)



TRACON		A (mm)	B (mm)	C (mm)	D (mm)	E (mm)
						
BV0603	BVZ0603	8,5	6	3	4,7	1,7
BV0705	BVZ0706	10,2	7,2	5	4,4	1,7
BV1006	BVZ1006	13,3	10	6,4	6,3	1,7
BV1108	BVZ1108	15,5	11	7,8	9	3
BV1410	BVZ1410	19,5	13,9	10,5	6,4	3,4
BV2015	BVZ2015	23,7	20,1	15,5	6,1	1,7
BV2518	BVZ2518	29,9	25,1	18,9	7,2	1,5
BV3225	BVZ3225	38,1	31,7	25	7,8	1,5

A külső hatásoknak ellenálló védőgyűrűket elsősorban szigetelt vezetéknek fém szerelőlapon készített éles szélű furatokon történő átvezetésére ajánljuk.

A vékony hártáival készült zárt kivitelek különböző kötődobozokhoz vezeték bevezető tömítésként is alkalmazható, az átvezetett kábelek, vezeték megfőrését, sérülését megakadályozza.

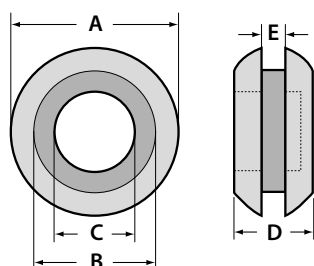

Öntapadós jelzőcímkék

A 20 mm átmérőjű jelzőcímkéket elosztószekrényekben, készülékekben gyűjtősínek, csatlakozókapcsok jelölésére ajánljuk.

TRACON	Megnevezés	Jelző-címke	TRACON	Megnevezés	Jelző-címke
JC01	1. fázisvezető váltakozó áramú rendszerekben	L1	JC09	Egyenáramú hálózat földelt középvezetője	PE
JC02	2. fázisvezető váltakozó áramú rendszerekben	L2	JC10	Váltakozó áramú hálózat földelt középvezetője	PEK
JC03	3. fázisvezető váltakozó áramú rendszerekben	L3	JC11	Európai Megfelelőségi jelölés	CE
JC04	Pozitív áramvezető egyenáramú rendszerekben	L+	JC12	Robbanásbiztos készülék (régébbi)	Ex
JC05	Negatív áramvezető egyenáramú rendszerekben	L-	JC13	Robbanásbiztos készülék	Ex
JC06	Nullavezető	N	JC14	Üzemi földelőkapocs	⏚
JC07	Egyenáramú hálózat középvezetője	M	JC15	Védővezető csatlakozókapocs	⏚
JC08	Elkülönített védővezető	PE			



TDZ / EVOZ

F/10



LIFETIME WARRANTY







Sorolósínek 125 A-ig

230/400 V AC U_i 500 V T_a -40...+85°C

Piktogramok **M/O**

TRACON		I_n	A mm ²	×17.5	L (mm)	H (mm)	h (mm)	W (mm)	xP
TFSS-1		max. 63 A	10 mm ²	56 mod.	1000	15.4	4.8	12.5	1
TFSS-1-12		max. 63 A	10 mm ²	12 mod.	215	15.4	4.8	12.5	1
TFSS-1+N		max. 63 A	10 mm ²	54 mod.	1000	19	9.2	21/15.3	1+N
TFSS-2		max. 63 A	10 mm ²	56 mod.	1000	29.4	17	10.4	2
TFSS-3		max. 63 A	10 mm ²	56 mod.	1000	29.5	18	21	3
TFSS-3-12		max. 63 A	10 mm ²	12 mod.	215	29.5	18	21	3
TFSS-4		max. 63 A	10 mm ²	56 mod.	1000	29.5	18.3	21.6	4
TFSS-1V		max. 63 A	10 mm ²	56 mod.	1000	14.8	5	15	1
TFSS-1V-12		max. 63 A	10 mm ²	12 mod.	215	14.8	5	15	1
TFSS-2V		max. 63 A	10 mm ²	56 mod.	1000	28.5	17	10.4	2
TFSS-3V		max. 63 A	10 mm ²	56 mod.	1000	28.5	17	15.5	3
TFSS-3V-12		max. 63 A	10 mm ²	12 mod.	215	28.5	17	15.5	3
TFSS-4V		max. 63 A	10 mm ²	56 mod.	1000	30	18.2	21.1	4
TFSS100-1		max. 100 A	25 mm ²	37 mod.	1000	13.7	4.5	16.8	1
TFSS125-1		max. 125 A	35 mm ²	37 mod.	1000	18.4	4.7	19.1	1

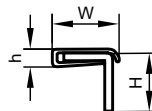
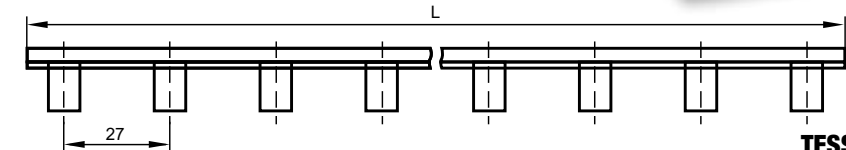
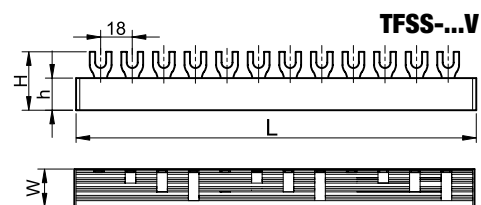
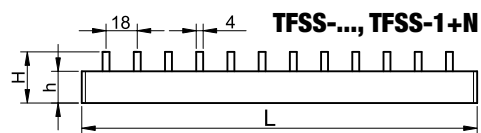

TFSS100-1, TFSS125-1

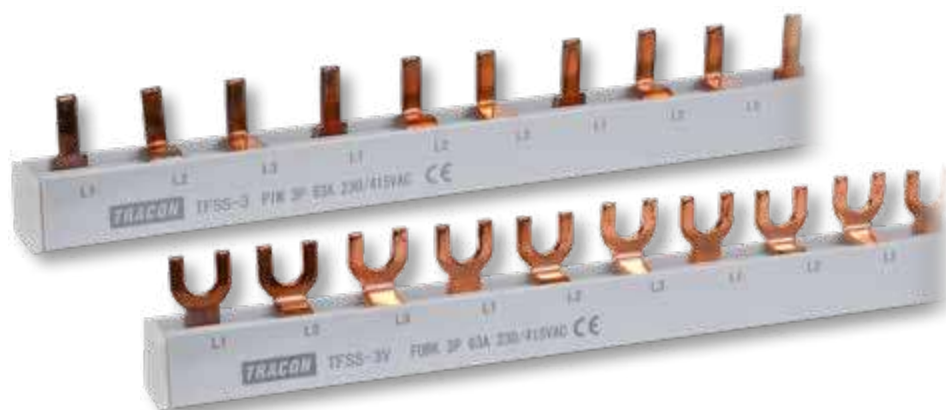

Egyéb kiegészítők

TRACON	Megnevezés
TFSS-1Z	Záróidom 1 pólusú 63A-es sorolósínekhez
TFSS-2Z	Záróidom 2 pólusú 63A-es sorolósínekhez
TFSS-3Z	Záróidom 3 pólusú 63A-es sorolósínekhez
TFSS-4Z	Záróidom 4 pólusú 63A-es sorolósínekhez
TFSS-1CS	csavaros csatlakozókapocs max. 25 mm ² -es vezetékhez
TFSSCOV	Érintésvédelmi burkolat

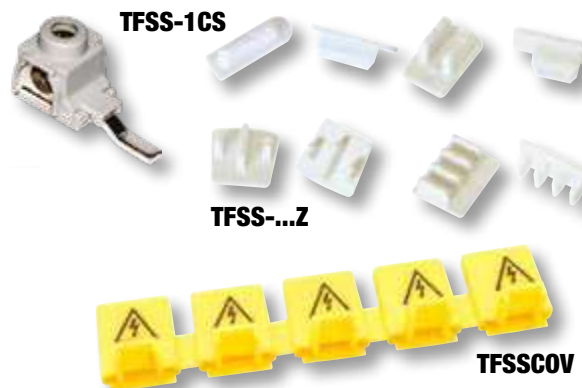

A TFSS- kódjelű sorolósínek kismegszakítók betáplálási oldalainak közösítésére, összekötésére szolgálnak. A csapos kivitelek hüvely kapcsokhoz, a villás kivitelek csavarfejjel szorítócsavaros csatlakozókapcsokhoz használhatók. A sorolósínek a szükséges méretre darabolhatók. Nagyobb áramú kismegszakítók és installációs készülékek betáplálására javasoljuk a **TFSS100-1** és **TFSS125-1** sorolósíneket! 27 mm-es osztástávolságuk miatt az egy modul széles (18mm) készülékek között 5 mm légtér alakul ki, így kevésbé lesz hőmérsékletfüggő a maximális terhelési áram. A pólusok egymáshoz képest kis mértékben elmozdíthatók.

Szerelősínek

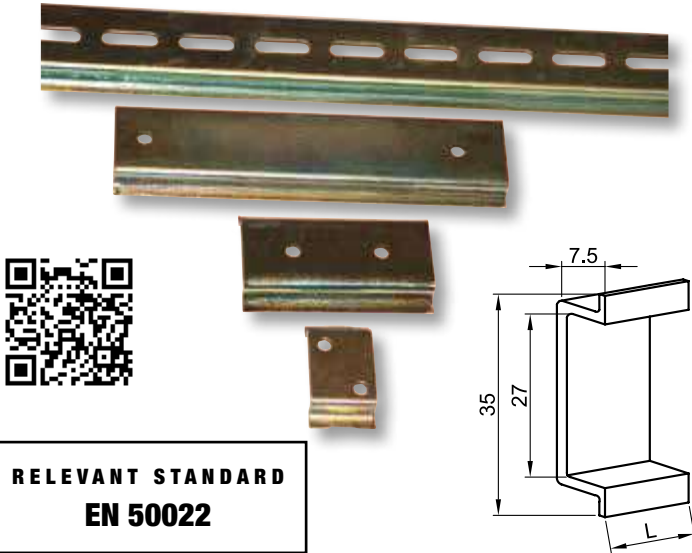

RELEVANT STANDARD
EN 50022

TRACON

		L (mm)
35/7,5SIN-1000		1000
35/7,5SIN-500		500
35/7,5SIN-137		137
35/7,5SIN-60		60
35/7,5SIN-20		20
35/7,5SIN-T-1000		1000
35/7,5SIN-T-200		200

Sorolható készülékek rögzítésére szolgáló 35 × 7.5 mm méretű „kalap” formájú galvanizált acél sínek.

Felerősítésük csavarral történik, ezért furattal, a hosszabb méretűek pedig ovális lyuksorozattal rendelkeznek.

Rézsíntartó bakok

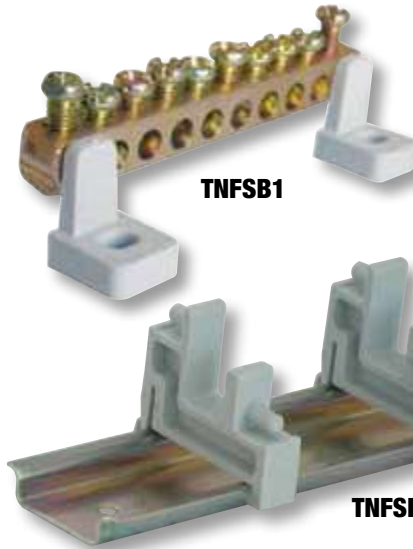

TRACON

Megnevezés

TNFSB1	Síntartó bak 1 db N/PE sínhez	TNFS, TNFS10, TNFS16, TNFS25
TNFSB	Síntartó bak 2 db N/PE sínhez	TNFS

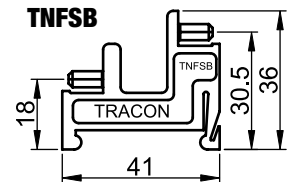
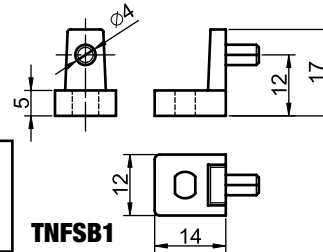

RELEVANT STANDARD
EN 50022

Rézsín (N/PE sín)

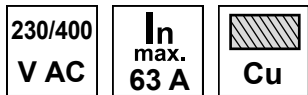

TRACON	H (mm)	W (mm)	L (mm)	∅ (mm)	x 	mm ²
TNFS	8	8	1 000	4.5	152 × M4	10 6
TNFS10	8	8	1 000	4.3	165 × M4	10 6
TNFS16	10	8	1 000	5.5	133 × M4	16 6
TNFS25	12	8	1 000	7.5	101 × M5	25 16

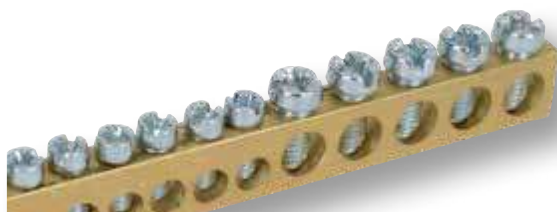

RELEVANT STANDARD
EN 60998

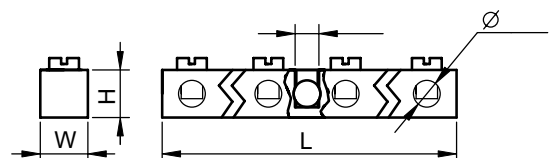

Szigetelt földelő sín



230/400 V AC	U _i 500 V	Cu	PA6.6	IP 20	T_a -40...+85°C	35×7.5
-----------------	-------------------------	----	-------	-----------------	-------------------------------------	--------

TRACON	(mm)	x	In	mm ²	L (mm)	L ₁ (mm)	L ₂ (mm)	H (mm)	W (mm)	d (mm)	M	
NPE-ZB		12			88	-	-	26	13	5,5	M5	
NPE-ZG		12			88	-	-	26	13	5,5	M5	
NPE-ZBK	6 × 9	12	max. 63 A	2,5-16 2,5-10	88	-	-	26	13	5,5	M5	
NPE-B6-4		4			-	49	34	35	10,5	5	M4	
NPE-B6-6		6			-	57	47	35	10,5	5	M4	
NPE-B6-8		8			-	70	60	35	10,5	5	M4	
NPE-B8-6		6			-	66	57	39	12,6	7	M5	
NPE-B8-8		8			-	79	34	28	10,5	7	M5	
NPE-B8-10	8 × 12	10	max. 100 A	4-35 4-25	-	100	91	39	12,6	7	M5	
NPE-B8-12		12			-	118	109	39	12,6	7	M5	
NPE-B8-14		14			-	134	137	39	12,6	7	M5	
NPE-G6-4	6 × 9	4	max. 63 A	2,5-16 2,5-10	-	49	34	35	10,5	5	M4	
NPE-G6-6		6			-	57	47	35	10,5	5	M4	
NPE-G6-8		8			-	70	60	35	10,5	5	M4	
NPE-G8-6		6			-	66	57	39	12,6	7	M5	
NPE-G8-8		8			-	79	34	28	10,5	7	M5	
NPE-G8-10	8 × 12	10	max. 100 A	4-35 4-25	-	100	91	39	12,6	7	M5	
NPE-G8-12		12			-	118	109	39	12,6	7	M5	
NPE-G8-14		14			-	134	136	39	12,6	7	M5	
NPE-BK6-4	6 × 9	4	max. 63 A	2,5-16 2,5-10	-	49	34	35	10,5	5	M4	
NPE-BK6-6	6 × 9	6	max. 63 A	2,5-16 2,5-10	-	57	47	35	10,5	5	M4	
NPE-BK6-8	6 × 9	8	max. 63 A	2,5-16 2,5-10	-	70	60	35	10,5	5	M4	
NPE-BK8-6	8 × 12	6	max. 100 A	4-35 4-25	-	66	57	39	12,6	7	M5	
NPE-BK8-8	8 × 12	8	max. 100 A	4-35 4-25	-	79	34	28	10,5	7	M5	
NPE-BK8-10	8 × 12	10	max. 100 A	4-35 4-25	-	100	91	39	12,6	7	M5	
NPE-BK8-12	8 × 12	12	max. 100 A	4-35 4-25	-	118	109	39	12,6	7	M5	
NPE-BK8-14	8 × 12	14	max. 100 A	4-35 4-25	-	134	137	39	12,6	7	M5	
NPE-Z-24*	6 × 9	24	max. 63 A	2,5-16 2,5-10	250	-	-	18,3	7,6	4×5,4+20×4,3	M4×20+M5×4	
NPE-Z-38*	8 × 12	38	max. 100 A	4-25 2,5-16	360	-	-	26,6	13,7	10×7,5+28×5,2	M6×10+M5×28	

* szerelőlapra való alkalmazáshoz

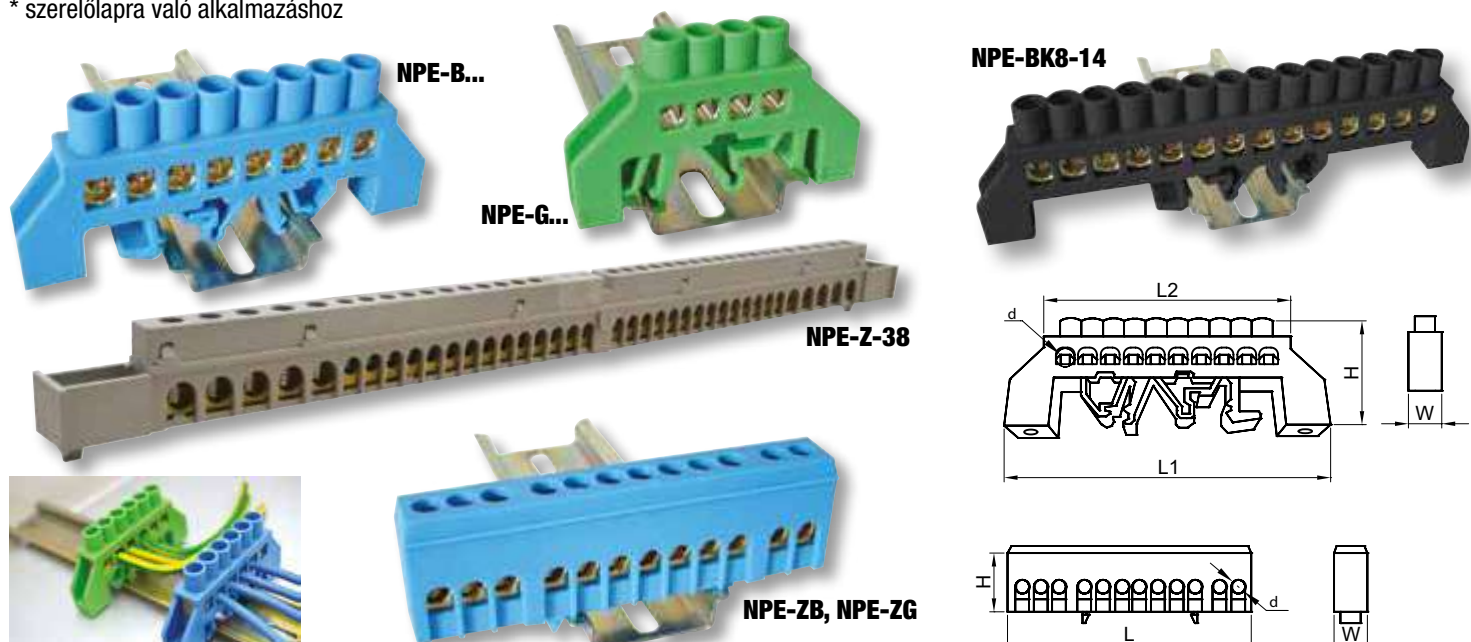

Falon kívüli kötődobozok



TRACON	D (mm)	L (mm)	W (mm)	H (mm)	IP..		d ₁ (mm)	d ₂ (mm)	
TQBYD70	70	-	-	40	IP 44	TQBY2-GB	23	29	
TQBYD85	85	-	-	45	IP 44	TQBY2-GB	23	29	
TQBY884	-	80	80	40	IP 44	TQBY2-GB	23	29	
TQBY8125	-	80	120	50	IP 44	TQBY3-GB	29 ±1	35 ±1	
TQBY10105	-	100	100	50	IP 54	TQBY3-GB	29 ±1	35 ±1	
TQBY15117	-	150	110	70	IP 54	TQBY3-GB	29 ±1	35 ±1	
TQBY15157	-	150	150	70	IP 54	TQBY4-GB	38 ±1	44 ±1	
TQBY19148	-	190	145	80	IP 65	TQBY4-GB	38 ±1	44 ±1	
TQBY25209	-	250	200	90	IP 65	TQBY4-GB	38 ±1	44 ±1	
TQBY312313	-	310	230	130	IP 65	TQBY5-GB	49 ±1	57 ±1	

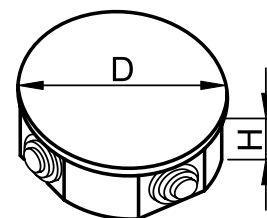
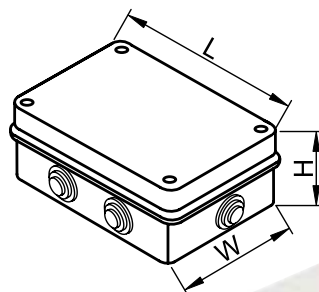

Gumibevezető

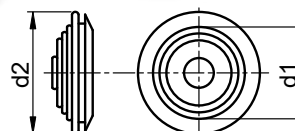

Elektronikai doboz



TRACON		W (mm)	L (mm)	H (mm)	IP..	
MED884		80	80	40	IP 44	
MED8125		80	120	50	IP 54	
MED10105		100	100	50	IP 54	
MED15117		150	110	70	IP 54	
MED15117S*		150	110	70	IP 54	
MED15157		150	150	70	IP 55	
MED15157T		150	150	70	IP 55	
MED12085*		120	80	50	IP 56	
MED383012		380	300	120	IP 56	
MED19148		190	145	80	IP 67	
MED19148T		190	145	80	IP 67	
MED25209		250	200	90	IP 67	
MED25209T		250	200	90	IP 67	
MED312313		310	230	130	IP 67	
MED312313T		310	230	130	IP 67	

* kikönyvítés nélkül.

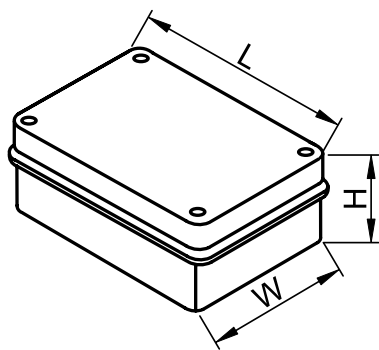

**MED8125,
MED10105,
MED15117,
MED15157**



**MED19148,
MED25209,
MED312313**

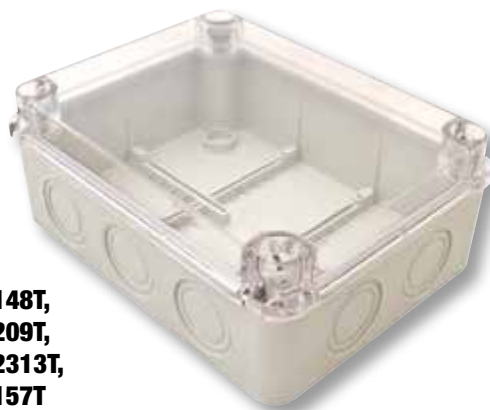

**MED19148T,
MED25209T,
MED312313T,
MED15157T**



MED383012



TME
H/8

Műanyag doboz



TRACON	W (mm)	L (mm)	H (mm)	
MD81212	80	120	120	-
MD101012	100	100	120	-
MD151114	150	110	140	-
MD191514	190	145	140	MD-SZL1
MD252016	250	200	160	MD-SZL2
MD312318	310	230	180	MD-SZL3
MD151114T	150	110	140	-
MD191514T	190	145	140	MD-SZL1
MD252016T	250	200	160	MD-SZL2
MD312318T	310	230	180	MD-SZL3

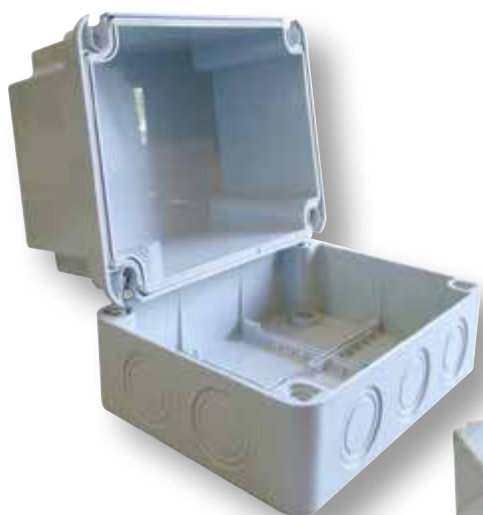

Galvanizált szerelőlap MD-dobozokhoz

MD-SZL1



MD-SZL2



TRACON



MD-SZL1	172 × 127 mm
MD-SZL2	228 × 179 mm
MD-SZL3	290 × 210 mm

RELEVANT STANDARD
EN 60670

RELEVANT STANDARD
EN 60423

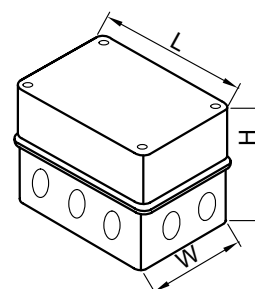

Műanyag szerelődobozok

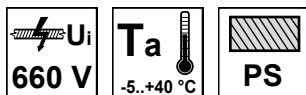

TRACON	L (mm)	W (mm)	H (mm)	IP..	
DN200X200	200	200	85	IP 44	× 2
DN250X250	250	250	110	IP 44	× 4

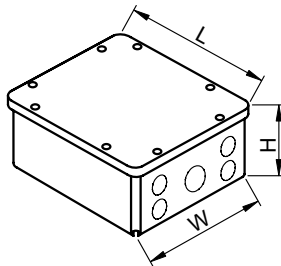

Falon kívüli rugalmas kötődobozok

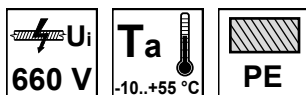

TRACON	L (mm)	W (mm)	H (mm)	IP..	
PD75X35	80	42	40	IP 54	× 8
PD75X75	75	75	40	IP 54	× 12
PD85X85	85	85	37	IP 54	× 12
PD100X100	100	100	40	IP 54	× 12

RELEVANT STANDARD
EN 60670

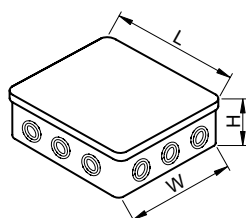

Gipszkarton dobozok

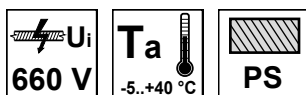

TRACON		L (mm)	W (mm)	H (mm)
GD6021	szervénydoboz, sima	65	65	45
GD60	szervénydoboz, mély	65	65	60
GD8021	kötődoboz, fedéllel	80	80	45
GD100	kötődoboz, fedéllel	100	100	45
GD71D	szervénydoboz, dupla	140	65	45

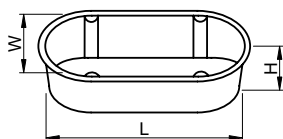
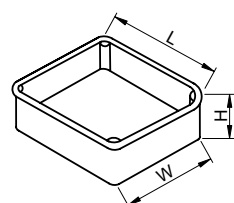

GD71D



GD6021



GD100



Süllyesztett perforált kötődobozok

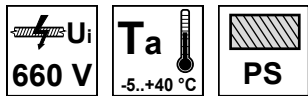

TRACON		D (mm)	H (mm)	W (mm)	L (mm)	H (mm)	IP..
D70	kerek	70	45	—	—	—	IP20
D80	kerek	80	45	—	—	—	IP20
D80X80	négyzetes	—	—	79	79	51.5	IP20
D100X100	négyzetes	—	—	104	104	51.5	IP20
D150X150	négyzetes	—	—	150	150	65.3	IP20
S100X100	négyzetes	—	—	100	100	48	IP20
S128X105	derékszögű	—	—	128	105	70	IP20
S163X108	derékszögű	—	—	163	108	70	IP20
S207X163	derékszögű	—	—	207	163	71	IP20



D70

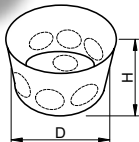

D100X100

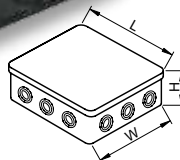

S163X108

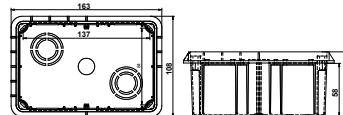

Süllyesztett perforált szerelvénydobozok

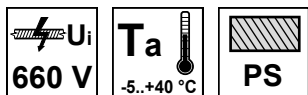

TRACON		D (mm)	L (mm)	W (mm)	H (mm)	×
D60	sima	62	—	—	40	2
D60S	sima, sorolható	64	15	—	40	2
D60SM	mély, sorolható	64	—	—	61	4
D70SZ	sima	72	—	—	36	9
D70SZT	sima, tetővel	72	—	—	36	9
D70D	dupla	70	140	70	44	8
D70TRI	tripla	70	212	70	44	12
D70/8	nyolcszögletű, sorolható	—	72	72	46	2

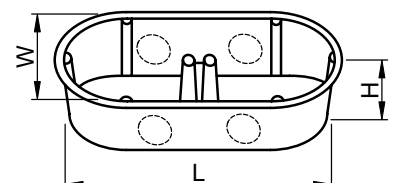
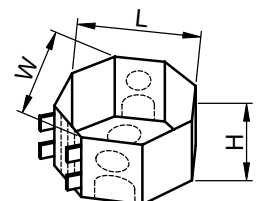
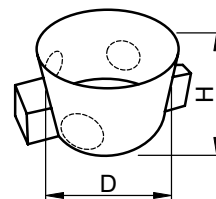

Dobozfedelek

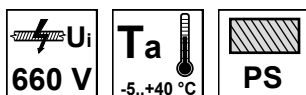

TRACON	Typ viečka	Ø (mm)
D60T	rúgós, fehér	69
D70T	rúgós, fehér	75
D80T	rúgós, fehér	89
VAKFED60	vakolófedél	65
VAKFED70	vakolófedél	76



RELEVANT STANDARD
EN 60670

Univerzális szerelvénydoboz

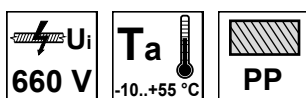

TRACON	H (mm)	D (mm)
UD70	110 - 130 - 160 mm	70

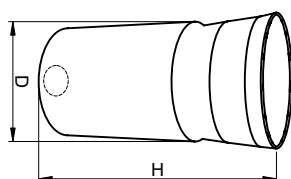

Külső szigetelt és burkolt falak szerelvényezéséhez alkalmazható. Az 1-es dobozt a hagyományos dobozokhoz hasonlóan a falba süllyeszteszük. Legalább 40, legfeljebb 80 milliméterre, olyan módon, hogy a 2-es doboz pereme valamelyik fokozatában a szigetelés külső síkjába essen.



Doboztoldás utólagos szigeteléshez

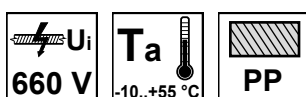

TRACON	H (mm)	D (mm)
UDT60	40 - 85 mm	70

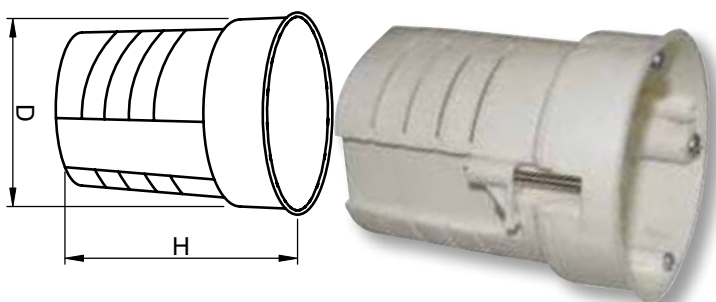

Szigetelt légvezeték-szerelvények

A kisfeszültségű szigetelt, saját súlya által mechanikailag terhelhető nullvezetővel rendelkező, pl. 1-AES, E-A2Y, KEVMEX-1, EX típusú légvezetékek gyors szerelését teszik lehetővé anélkül, hogy magát a légvezeték-hálózatot feszültségmentesíteni kellene. A szerelési művelet az élő hálózaton a szigetelt szerelvények és szigetelt szerszámok segítségével üzembiztosan elvégezhető.

A csavaros kötőelemek segítségével az épületek betápláló kábelének leágaztatása a légvezetékéről egyszerűen elvégezhető. Ha a közvilágítási tápfeszültség az energiaelosztó hálózat légvezetékének kísérő vezetéke által van biztosítva, a kötőelemek által a közvilágítási nyomvonal is könnyedén kiépíthető.

A mechanikailag terhelhető nullvezetőjű légvezetékek elvi elrendezését a mellékelt ábrák szemléltetik.

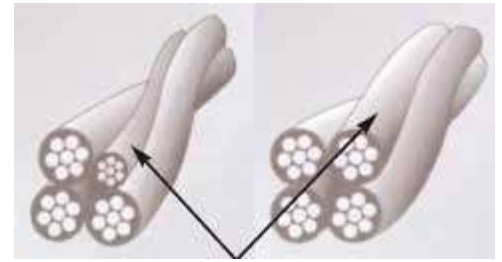

A légvezeték nullvezetője

Feszítő szerelvények

TRACON				a (mm)	b (mm)	c (mm)	h (mm)	
TSZK2-A	25-35 mm ²	2,5 kN	4 kN	250	35	63	162	4 kV
TSZK2-B	50-120 mm ²	2,5 kN	4 kN	420	55	100	275	4 kV

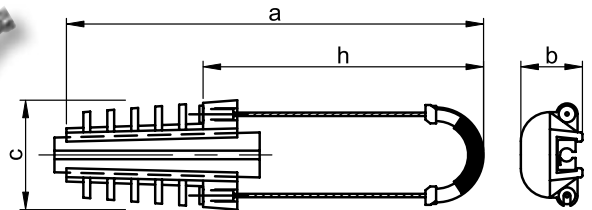

RELEVANT STANDARD
MSZ 275

A feszítő szerelvényekkel a szigetelt légvezetékek feszítő oszlophoz való rögzítése végezhető el gyorsan, egyéb szerszám felhasználása nélkül. A nullvezetőt a szerelvény gumi végébe kell behelyezni, majd a fém feszítő végét az oszlopon található kampóra akasztani. Feszítéskor a gumiágy erősen rászorul a kábelre, a feszítőerőt a kábel saját súlya biztosítja.

Függesztő szerelvények

TRACON			a (mm)	b (mm)	c (mm)	
TSZK1-A	25-35 mm ²	12 kN	120	83	40	4 kV
TSZK1-B	50-120 mm ²	12 kN	152	100	40	4 kV



TSZK1-A

Fix, szorítócsavarral



TSZK1-B

Csuklós, biztosító lappal

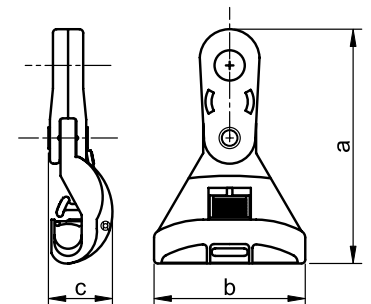

A feszítő szerelvényekkel a szigetelt légvezetékek feszítő oszlophoz való rögzítése végezhető el gyorsan, egyéb szerszám felhasználása nélkül. A nullvezetőt a szerelvény gumi végébe kell behelyezni, majd a fém feszítő végét az oszlopon található kampóra akasztani. Feszítéskor a gumiágy erősen rászorul a kábelre, a feszítőerőt a kábel saját súlya biztosítja.





Csavaros kötőelemek

A csavaros kötőelemmel üzembiztos erenkénti leágazást lehet létesíteni a feszültség alatt álló szigetelt légvezeték-hálózaton. Nagyfokú biztonságot jelent, hogy a szorítócsavar és az érintkezőkések közötti szigetelés átütési szilárdsága legalább 4 kV levegőben.

További védelmet jelent a leágazó vezeték végét takaró sapka felhelyezése, mely az érintés és a behatoló szennyeződések ellen véd.





A mechanikai kapcsolat az érintkezőkések közvetítésével a vezeték szigetelésének átvágása után a megfelelő nyomatékkal meghúzott szorítócsavar által jön létre. A csatlakozás korrózióállóságát a csatlakozó terület speciális zsírzása biztosítja.

Normál csavarral szerelt kivitel

TRACON				X 
TSZL4-1	16-95 mm ²	10-25 mm ²	4 kV	1 × M8
TSZL4-2	70-95 mm ²	70-95 mm ²	4 kV	1 × M8
TSZL4-3	120-185 mm ²	16-25 mm ²	4 kV	1 × M8
TSZL4-4	70-185 mm ²	70-185 mm ²	4 kV	2 × M8



Szakadófejes szorítócsavarral szerelt kivitel

TRACON				X 
TSZL6-1	25-95 mm ²	2,5-25 mm ²	6 kV	1 × M8
TSZL6-2	70-95 mm ²	70-95 mm ²	6 kV	1 × M8
TSZL6-3	120-185 mm ²	10-25 mm ²	6 kV	1 × M8
TSZL6-4	120-185 mm ²	70-185 mm ²	6 kV	2 × M8

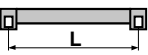
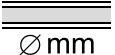

LTT Légvezeték-távtartó

TRACON		
	L	∅ mm
LTT	350 mm	max. 12 mm
LTTM	350 mm	max. 12 mm



A távolságtartó felhasználásával a 230/400 V-os kisfeszültségű légvezetési hálózatok szigetetlen vezetőinek egymástól való távolsága biztosítható két tartóoszlop között. Alkalmazásával megelőzhető az erős légmozgások, szélviharok által okozott zárlatok, üzemviteli zavarok kialakulása. A műanyagból készült távolságtartó kb. 350 mm-re tartja a két vezetékét egymástól, a vezetékeket rugóval működő szorítóelem rögzíti.

RELEVANT STANDARD
MSZ 275

TB Tetőtartó bevezető

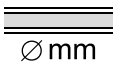
TRACON		L (mm)	W (mm)	D ₁ (mm)	D ₂ (mm)
	∅ mm				
TB-1.5	1,5"	115	110	34 (1,5")	33 × 41
TB-2	2"	115	110	44 (2")	33 × 41
TB-2.5	2,5"	115	110	58 (2,5")	33 × 41



A tetőtartó bevezető alkalmazásával lehetséges a 230/400 V-os kisfeszültségű légvezetési energiaelosztó hálózatról az épületek villamos energiaellátását biztosító szigetelt vezetékek sérülésmentes bevezetése az ún. tetőtartó acélcsővekbe. A bevezető egyúttal biztosítja, hogy az acélcsőbe a csapadék (eső, hó) ne kerülhessen be. A bevezető 1,5", 2" és 2,5" méretű acélcsővekhez készül. A két részből álló, műanyagból készült bevezető kúpos kiképzésű alsó része – további rögzítő eszköz nélkül – befeszül a megfelelő méretű acélcsőbe, felső része a vezetékek elhelyezése, bevezetése után csavarokkal rögzíthető az alsó részhez.

