

































Pictogrammes des en-têtes de tableau

 Notes, commentaires	 Durée de shuntage (h)	 Couleur	 Longueur du circuit de bouton-poussoir
 I_{imptotal} 10/350µs Courant de foudre max.	I_n Courant nominal (A)	 $\times \frac{L}{D}$ Nombre de LED (unité)	IP.. Type de protection
U_p Niveau de protection de tension	 I_{imp} 1P 10/350µs Courant de foudre	U_n Tension nominale (V)	I_n L-N 8/20µs Courant nominal de fonctionnement
 Icn EN60698 Pouvoir de coupure nominal sous court-circuit du disjoncteur	U_c Tension de service permanente maximale	I_{max} 8/20µs Courant maximal de décharge	 Dimensions (LxWxH)
$I_{\Delta n}$ (mA) Courant résiduel nominal	I_e Courant nominal de service	U_m Tension de commande nominale	 Section de fils de raccordement mm ²
 U_{up} Niveau supérieur de protection de tension	P_{max} Puissance nominale	P_s Consommation de puissance propre	 NC NO CO Contacts
 $\times P$ Nombre de pôles	 U_{down} Niveau inférieur de protection de courant	 C Courbe caractéristique de déclenchement	 Prise avec clapet
 I_{sec} Courant secondaire maximal	 $\times 17.5$ Nombre de modules	 Côté gauche du disjoncteur	Σ Nombre de boutons-poussoirs applicables:
 à contact de terre médian	 U_{sec} Tension secondaire	 U_{pr} Tension primaire	
 Système de réseau	 avec borne de terre	 Prise normale	

Pictogrammes des données techniques

230 V AC Tension nominale (V)	 50/60 Hz Fréquence nominale	 Luminaire applicable aux parois latérales et plafond	IP 54 Type de protection
 Puissance acoustique	 rel % 30-90 Humidité relative	 T_a -40..+105 °C Température ambiante	 low batt Indication de tension de batterie faible
 Cassette débrochable	 Compact	 -AUX 1xNO Contacts auxiliaires	 [mm ²] 0,75-2,5 Câble de branchement
 F_t Fusible thermique	 Éclateur à étincelles	 Varistance	 Signal optique
 Fusible de sauvegarde recommandé 63 A gG	 I_{2t} 3 Classe d'efficacité énergétique	E3 Classe d'efficacité énergétique	 R ≥ 0.5mΩ Résistance
 Appareil de mesure à affichage LCD LCD	 Luminaire de classe de protection II contre les contacts	 AC pour réseaux à courant alternatif	 A, AC pour réseaux à courant alternatif et continu pulsé
U_{imp} 6 kV Tension nominale de tenue au choc	 U_i 690 V Tension d'isolation nominale	 Durée de vie électrique $\times 10.000$	 Durée de vie mécanique $\times 10.000$
 Icn EN60698 10 kA Pouvoir de coupure nominal sous court-circuit du disjoncteur	 Luminaire pour paroi latérale	P_m 0,8 W Consommation de puissance propre	 [h] 20.000 Durée de vie
 Plombable en position «0-1-2»	 OFF Plombable en position «ARRÊT»	 8mm Distance entre contacts	V0 UL94 Résistance au feu selon UL 94
 Montage sur rail de montage. 35x7.5	 Les appareils sont montables sur des peignes de distribution à broches	 Les appareils sont montables sur des peignes de distribution à broches et/ou à fourches	 Type de déclencheur: Thermomagnétique



Parafoudre de type 1 **4**



Parafoudres combinés (type 1 + 2) **4**



Parafoudres de type 2 **5**



Parafoudres CC de type 2 **5**

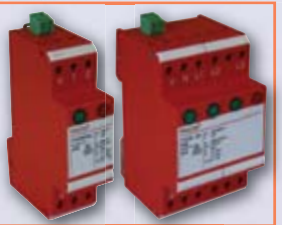

Parafoudres de type 3 (protection "fine"), version modulaire **6**



Condensateur de type 2+3 (pour driver de LED) **6**

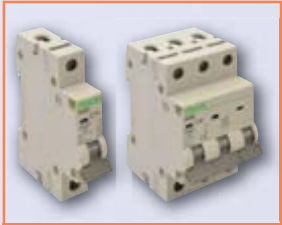

Disjoncteurs miniatures EVOZ **12**

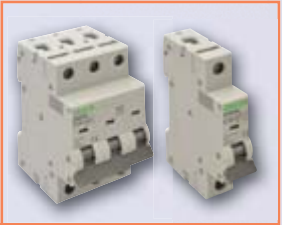

Disjoncteurs miniatures EVOTDA **13**



Disjoncteurs miniatures à fort courant EVOH **14**



Disjoncteurs miniatures EVON **15**



Appareils combinés de protection EVOK **16**



Disjoncteurs à courant résiduel EVOV **17**

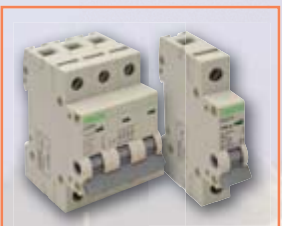

Interrupteurs d'isolation EVOTIK **19**



Commutateurs modulaire EVOSVK **20**



Interrupteurs-sectionneurs verrouillables EVOMS **21**



Voyants lumineux EVOSLJL **21**



Boutons-poussoir modulaires EVOP **22**



Transformateurs de sécurité (sonnette) EVOBT **22**



Contacteurs d'installation EVOHK **23**



Réenclencheurs automatiques sous et sur-tension **24**



Disjoncteurs MB **27**



Disjoncteurs TDZ **28**



Disjoncteurs CC pour réseaux électriques CC **29**



Disjoncteurs à courant résiduel KVK **31**



Interrupteurs automatiques à courant différentiel résiduel RB **32**



Interrupteur à courant résiduel avec commande motorisée automatique de relogage **35**



Minuteriers d'escalier **37**



Relais d'impulsion **38**



Sonnettes **38**



Prises modulaires **39**



Prises et interrupteurs en saillie **40**



Prise Shuko avec port USB **43**



Transformateur de sécurité (sonnette) **43**



Détecteur de monoxyde de carbone **44**



Détecteur de fumée sans fil interconnectable **45**

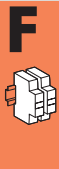

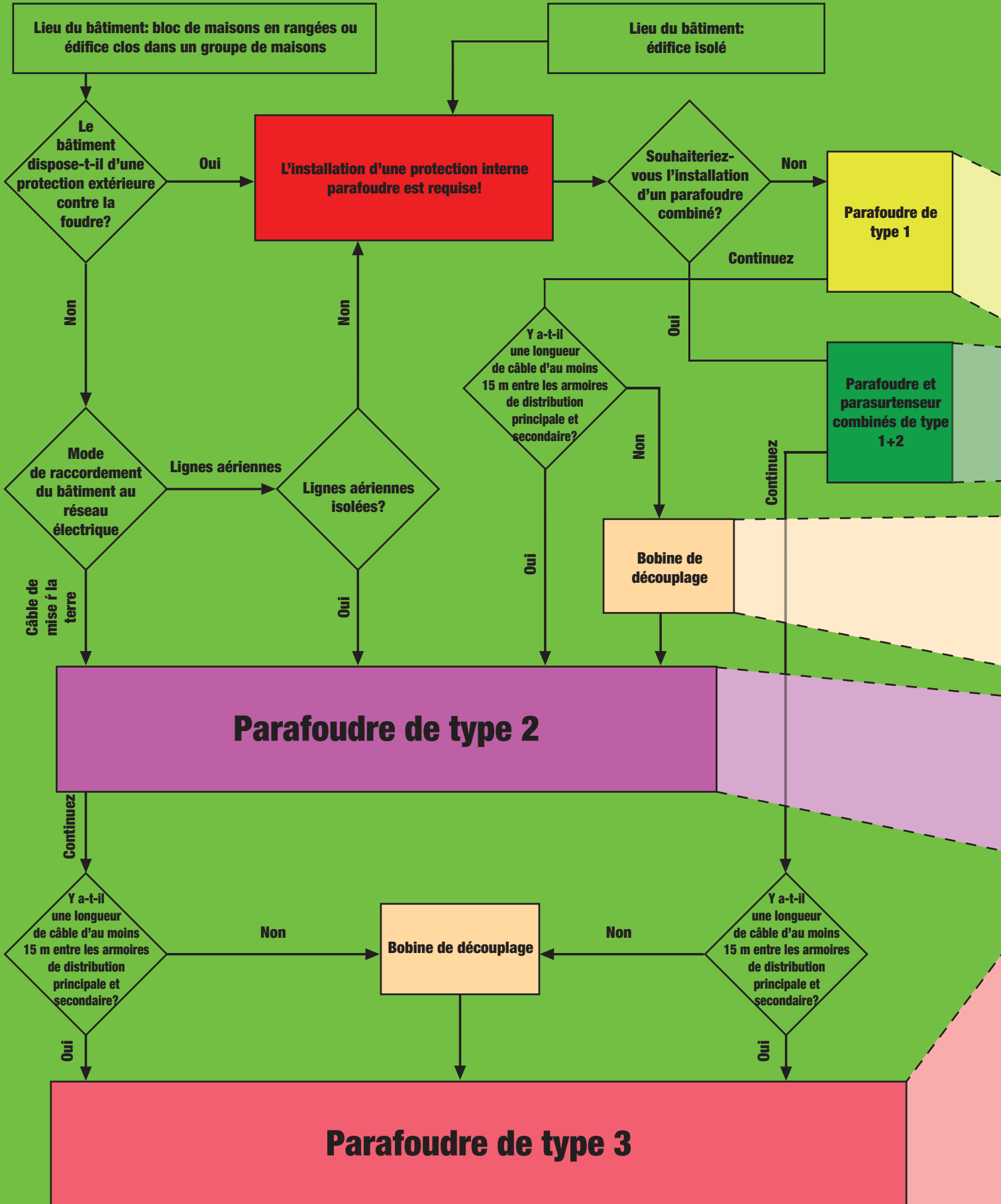

Guide de sélection

En raison de la complexité du dispositif, nous recommandons à l'utilisateur de faire appel à un professionnel qui proposera la solution adaptée pour la mise en œuvre d'un système de protection contre la foudre et les surtensions associées.

Pour un montage plus aisé, nous avons réalisé un petit guide sous forme de diagramme. Vous y trouverez les éléments nécessaires à la protection du réseau électrique.

Commencez à lire le diagramme à partir de la case correspondant au lieu d'installation puis suivez les flèches qui amènent au parafoudre de niveau 3. Une protection minimale exige au minimum, l'installation de parafoudres de type 2 et 3.

Les parafoudres de types 1 et 1+2 s'installent au niveau du tableau de distribution principal des bâtiments tandis que nous conseillons l'installation des parafoudres de type 2 et 3 dans des tableaux divisionnaires. La protection de type 3 au niveau du tableau divisionnaire doit être renouvelée lorsque les éléments sensibles sont éloignés de plus de 30 mètres du parafoudre de tête d'installation de type 3. Pour la protection des systèmes à courant faible, nous vous recommandons d'utiliser nos rallonges protégées. Pour plus de détails, veuillez consulter notre annexe.

Parafoudre de type 1



F/4

Limiteurs de surtension CC



F/6

Bobine de découplage



F/7

Parafoudre et parasurtenseur combinés de type 1+2



F/4

Parafoudre de type 2



F/5

Parafoudre de type 3



F/6 - F/7

Multiprises protégées



G/9 - G/10

Parafoudre de type 1

125 A gG IP 20 1xNO TT 2,5-35 Ta -40..+55°C 35x7.5 V0 UL94 Pictogrammes F/0

TRACON	xP	I _{imp} 1P 10/350µs	I _{limptotal} Σ 10/350µs	U _n	U _p	U _c	W (mm)	
TTV1-50-1P	1P	25 kA	50 kA	230 V,			18	TN, TT
TTV1-50-2P	2P	25 kA	50 kA	50 Hz; 1~			36	TN, IT
TTV1-50-3P	3P	25 kA	50 kA	3x230/400 V, 50 Hz; 3~	0,9/1,5 kV	260 V, AC	54	TN, TT
TTV1-50-3P+N/PE	3P+N/PE	25 kA	50 kA				72	TN, TT
TTV1-50-4P	4P	25 kA	50 kA				72	TN, IT



Ces dispositifs sont adaptés pour la mise à la terre des ondes de choc de type 10/350 µs pouvant apparaître sur tout réseau d'alimentation électrique triphasé ou monophasé (lignes aériennes) exposé à la foudre. Versions compactes (intégrées). Les parafoudres de type 1 doivent être installés dans l'armoire de distribution principale directement après le premier dispositif de protection contre les courts-circuits et juste après le compteur de consommation.



RELEVANT STANDARD
EN 61643

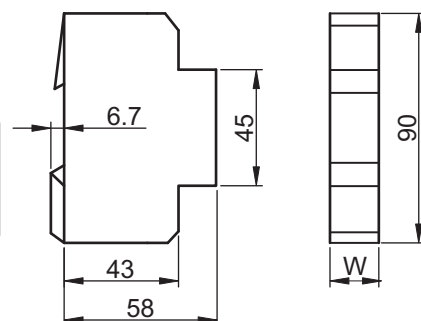

Se référer au guide de sélection en page F/2-3.

Parafoudres combinés (type 1 + 2)

125 A gG IP 20 1xCO TT 6-35 Ta -40..+55°C 35x7.5 V0 UL94 V Ft Pictogrammes F/0

TRACON	xP	I _{imp} 1P 10/350µs	I _{max} 8/20µs	U _n	U _p	U _c	W (mm)	
TTV1+2-100-1P	1P	8 kA	100 kA	230/400 V, 50 Hz	2,2 kV	385 V AC, 500 V DC	27	TN, TT, IT
TTV1+2-100-2P	2P	8 kA	100 kA				54	TN, TT, IT
TTV1+2-100-3P	3P	8 kA	100 kA				81	TN, TT, IT
TTV1+2-100-4P	4P	8 kA	100 kA				108	TN, TT, IT
TTV1+2-100-3P+N/PE	3P+N/PE	8 kA	100 kA				108	TN, TT, IT
TTV1+2-80-1P	1	8 kA	80 kA	230/400 V, 50 Hz	2,2 kV	385 V AC, 500 V DC	27	TN, TT, IT
TTV1+2-80-2P	2	8 kA	80 kA				54	TN, TT, IT
TTV1+2-80-3P	3	8 kA	80 kA				81	TN, TT, IT
TTV1+2-80-4P	4	8 kA	80 kA				108	TN, TT, IT
TTV1+2-80-3P+N/PE	3P+N/PE	8 kA	80 kA				108	TN, TT, IT

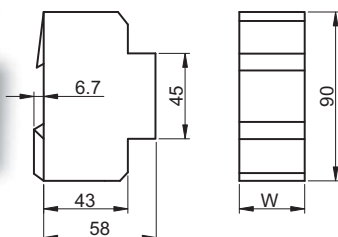

Ces dispositifs sont prévus pour la limitation des surtensions provoquées par les surintensités provenant éventuellement des ondes de choc à grande énergie de type 10/350 µs et/ou des commutations (ondes 8/20 µs) pouvant apparaître sur tout réseau triphasé ou monophasé (lignes aériennes) d'alimentation électrique. Versions compactes (intégrées). Les parafoudres de type 1 et 2 doivent être installés dans l'armoire de distribution principale directement après le premier dispositif de protection contre les courts-circuits et juste après le compteur de consommation (dans l'armoire de distribution principale).

Attention! La capacité de décharge des dispositifs combinés n'atteint pas la capacité de décharge des dispositifs simples!

Un dimensionnement approprié des appareils permettrait leur utilisation dans les systèmes photovoltaïques (CC).

Parafoudres de type 2

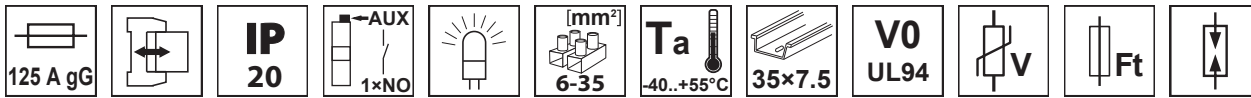

TRACON	xP	I _n L-N 8/20µs	I _{max} 8/20µs	U _n	U _p	U _c	W (mm)	
TTV2-60-1P	1P	30 kA	60 kA	230 V, 3x230/400 V	2,0 kV	385 V AC	18	TN, TT, IT
TTV2-60-2P	2P	30 kA	60 kA				36	TN, TT, IT
TTV2-60-3P	3P	30 kA	60 kA				54	TN, TT, IT
TTV2-60-3P+N/PE	3P+N/PE	30 kA	60 kA				72	TN, TT, IT
TTV2-60-4P	4P	30 kA	60 kA				72	TN, TT, IT
TTV2-40-1P	1P	20 kA	40 kA				18	TN, TT, IT
TTV2-40-2P	2P	20 kA	40 kA		36	TN, TT, IT		
TTV2-40-3P	3P	20 kA	40 kA		54	TN, TT, IT		
TTV2-40-3P+N/PE	3P+N/PE	20 kA	40 kA		72	TN, TT, IT		
TTV2-40-4P	4P	20 kA	40 kA		72	TN, TT, IT		
TTV2-30-1P+N/PE*	1P+N/PE	15 kA	30 kA		1,5 kV	320 V AC	18	TN, TT, IT
TTV2-30-3P+N/PE**	3P+N/PE	15 kA	30 kA		36	TN, TT, IT		
TTV2-20-1P	1P	10 kA	20 kA	1,5 kV	385 V AC	18	TN, TT, IT	
TTV2-20-2P	2P	10 kA	20 kA			36	TN, TT, IT	
TTV2-20-3P	3P	10 kA	20 kA			54	TN, TT, IT	
TTV2-20-3P+N/PE	3P+N/PE	10 kA	20 kA			72	TN, TT, IT	
TTV2-20-4P	4P	10 kA	20 kA	72	TN, TT, IT			

* parafoudres dans un appareil de largeur modulaire pour les réseaux monophasés de types TNC-S et TNS

** 4 parafoudres dans un appareil à double largeur modulaire pour les réseaux triphasés de types TNC-S et TNS

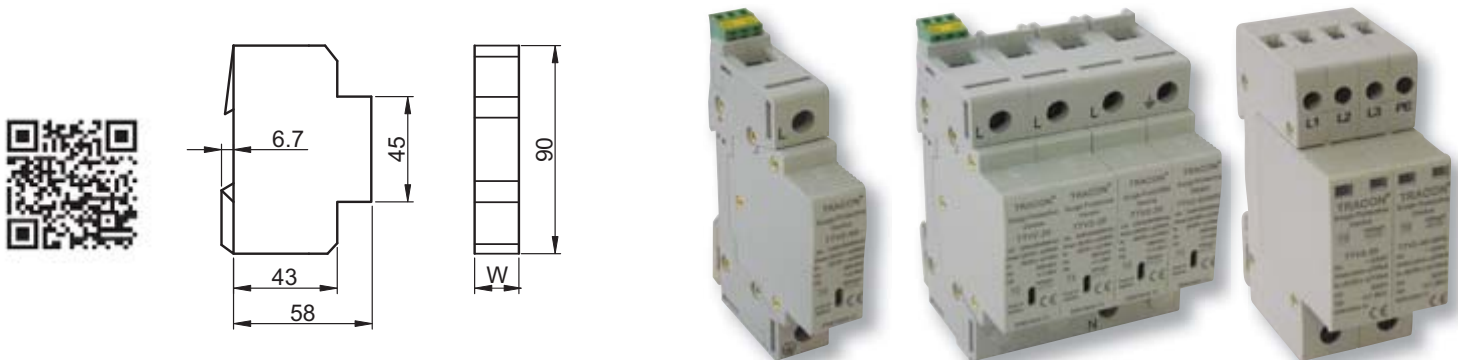

Les parafoudres de type 2 permettent de décharger les surtensions produites par les commutations de forme 8/20 µs.

Les parafoudres de type 2 doivent être installés dans les tableaux divisionnaires (tableau divisionnaire de l'appartement en cas de bâtiments abritant plusieurs appartements) en aval des tableaux principaux contenant les parafoudres de type 1 du réseau de distribution.

Pour un bon fonctionnement du système, un câble d'une longueur d'au moins 10 à 15 m ou une bobine de découplage doit être installé entre les parafoudres de type 1 et 2. Versions à modules interchangeables. Le contact auxiliaire est placé dans le socle.

Socles + Inserts

TRACON	I _n L-N 8/20µs	I _{max} 8/20µs	W (mm)	TTV2-BASE-1P	TTV2-BASE-2P	TTV2-BASE-3P	TTV2-BASE-4P
TTV2-60-M	30 kA	60 kA	18	-	OK	OK	OK
TTV2-40-M	20 kA	40 kA	18	OK	-	-	-
TTV2-30-A-M*	15 kA	30 kA	18	-	-	-	-
TTV2-30-B-M**	15 kA	30 kA	18	-	-	-	-
TTV2-20-M	10 kA	20 kA	18	OK	-	-	-
TTV2-40-N/PE-M	20 kA	40 kA	18	-	OK	OK	OK

*Insert 2P pour appareil TTV2-30-3P+N/PE

**Insert 1P+N/PE pour appareils TTV2-30-1P+N/PE en TTV2-30-3P+N/PE



Parafoudres CC de type 2

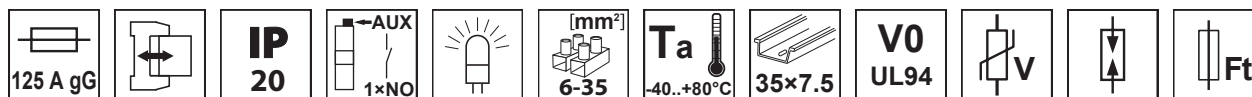

TRACON	xP	U_n	U_p	U_c	I_n L-N 8/20µs	I_{max} 8/20µs
TTV2-40-DC-600	3 P	600 V DC	3 kV	800 V DC	20 kA	40 kA
TTV2-40-DC-1000	3 P	1000 V DC	4 kV	1200 V DC	20 kA	40 kA



Inserts

TRACON	I_n L-N 8/20µs	I_{max} 8/20µs	U_p
TTV2-40-DC-600-M	20 kA	40 kA	3 kV
TTV2-40-DC-1000-M	20 kA	40 kA	4 kV
TTV2-40-DC-600-V	20 kA	40 kA	3 kV
TTV2-40-DC-1000-V	20 kA	40 kA	4 kV
TTV2-40-DC-600-G	20 kA	40 kA	3 kV
TTV2-40-DC-1000-G	20 kA	40 kA	4 kV

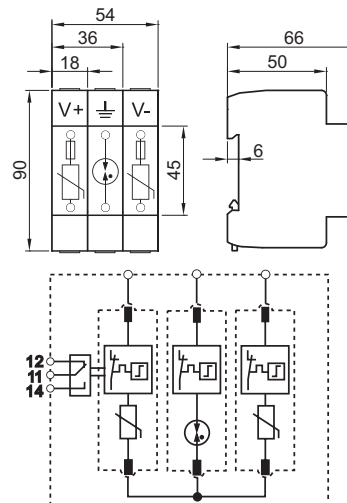

RELEVANT STANDARD
EN 61643

Les parafoudres de type 2 permettent de décharger les surtensions produites par les commutations de forme 8/20 µs. Ils sont conçus spécialement pour l'utilisation dans les circuits électriques des systèmes de panneaux solaires (PV). Versions à modules interchangeables. Le contact auxiliaire est installé dans le socle.

Parafoudres de type 3 (protection "fine"), version modulaire

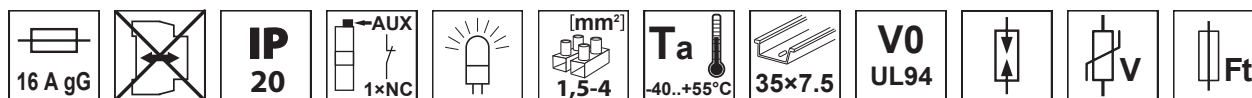

TRACON	xP	I_n L-N 8/20µs	I_{max} 8/20µs	U_n	U_p	U_c	W (mm)	
TTV3-10-1P+N/PE	1P+N/PE	5 kA	10 kA	230 V, 50 Hz; 1~	1,5 kV	385/440 V	36	TN, TT
TTV3-10-3P+N/PE	3P+N/PE	5 kA	10 kA	3x230/400 V, 50 Hz; 3~	1,5 kV	385/440 V	72	TN, IT



RELEVANT STANDARD
EN 61643

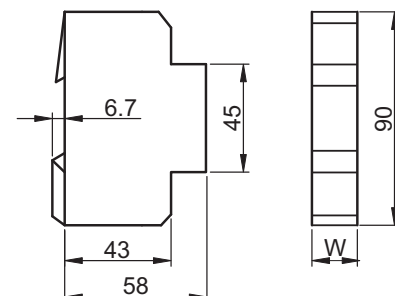

Les parafoudres de type 3 doivent être installés le plus près possible de l'équipement sensible. Les unités de protection secondaires contre la foudre limitent les pics de tension provenant des commutations effectuées dans le réseau et empêchent que les perturbations causées par les surtensions ne parviennent aux équipements électroniques par l'intermédiaire des câbles de distribution et les endommagent. Versions compactes (intégrées). Attention! Ils ne sont cependant pas en mesure de protéger seuls les équipements contre les surtensions.

Les versions montables sur tableaux mono- et triphasés peuvent être raccordées en parallèle ou en série avec les équipements à protéger. En cas de branchement en série, l'équipement à protéger doit être installé en aval du dispositif de protection contre les surintensités.

Parafoudres de type 3 (protection "fine"), version intégrable

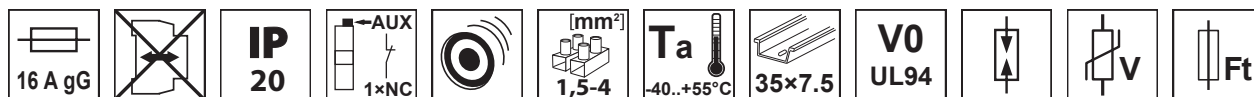

TRACON	$\times P$ 1P2P 2P	I_n L-N 8/20 μ s	I_{max} 8/20 μ s	U_n	U_p	U_c	
TTV3-5-1P+N-PE	1P+N-PE	2,5 kA	5 kA	230 V, 50 Hz; 1~	1,25 kV	255 V AC	TN, IT

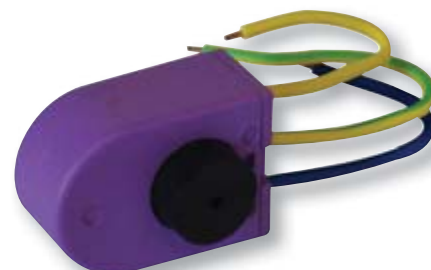
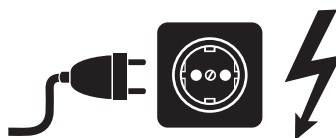
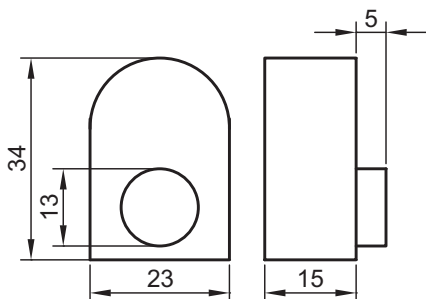

Les parafoudres de type 3 doivent être installés le plus près possible de l'équipement sensible.

Les unités de protection secondaires contre la foudre limitent les pics de tension provenant des commutations effectuées dans le réseau et empêchent que les perturbations causées par les surtensions ne parviennent aux équipements électroniques par l'intermédiaire des câbles de distribution et les endommagent. Versions compactes (intégrées).

Attention! Ils ne sont cependant pas en mesure de protéger seuls les équipements contre les surtensions.

Condensateur de type 2+3 (pour driver de LED)

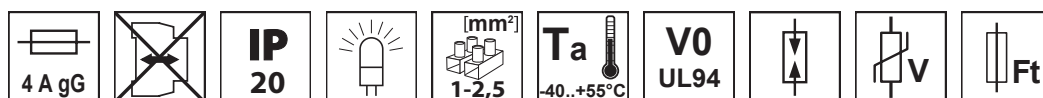

TRACON	I_n L-N 8/20 μ s	I_{max} 8/20 μ s	U_n	U_p	U_c	
TTVL2+3-10	5 kA	10 kA	230 V, 50 Hz	1,5 kV	320 V AC	TN, IT



Le condensateur compact TTVL2+3 de type 2+3 pour driver de LED protège tous les drivers à phase unique 120-277VAC des effets de la foudre et des phénomènes transitoires.

Tout défaut est indiqué par une diode allumée sur l'appareil.

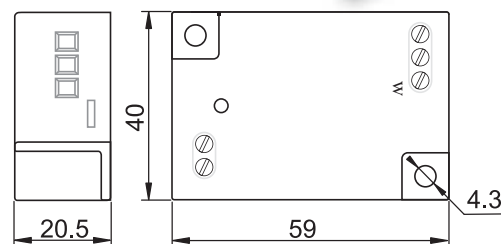

Bobine de découplage

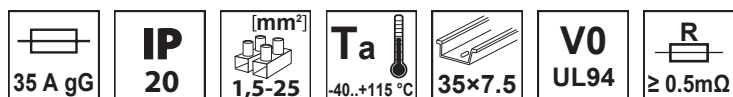

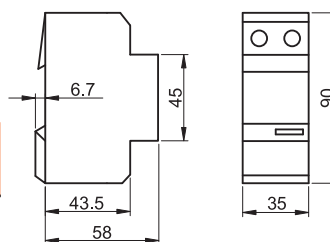

TRACON	$\times 17,5$ 2	I_n	U_n	L
TTV-CSF35	2	35 A	500 V AC/DC	18 μ H \pm 10 %



La condition de base pour un ordre de fonctionnement coordonné entre les parafoudres de type 1 et les parasurtenseurs de type 2 en aval dans les systèmes complexes de protection contre les surtensions est d'installer entre ces dispositifs une impédance de valeur proportionnelle à la différence de tension créée. Cette condition est généralement remplie si le câble entre les deux dispositifs de protection est d'une longueur égale à 10 à 15 m au moins.



Disjoncteurs

TRACON			I_n	I_{cn} EN60698	
EVON	C	1+N	6 – 32 A	4,5 kA	F/15
EVOZ	B, C	1, 2, 3, 4	1 – 63 A	6 kA	F/12.
EVOTDA	B, C	1, 2, 3, 4	1 – 63 A	10 kA	F/13.
EVOH	C	1, 2, 3, 4	63 – 125 A	10 kA	F/14.
DPN	C	1+N	6 – 32 A	4,5 kA	F/26.
MB	B, C	1, 2, 3	6 – 63 A	4,5 kA	F/27.
TDZ	B, C, D	1, 2, 3, 4	1 – 63 A	6 kA	F/28.
DC	C	1, 2, 3, 4	6 – 63 A	6/10 kA	F/29.
KMH	C	1, 2, 3, 4	63 – 125 A	6 kA	F/30.

Les disjoncteurs servent à protéger contre toute surcharge des réseaux électriques, à prévenir tout défaut dû aux courts circuits électriques et à la mise en œuvre de la protection contre les dommages environnementaux et les accidents. Le déclenchement du disjoncteur est provoqué par un bilame métallique (en cas de surcharge), par déclencheur électromagnétique (en cas de court-circuit) ou manuellement. La commutation des pôles des versions à pôles multiples se fait simultanément.

Caractéristiques de déclenchement

La norme EN 60898 définit les caractéristiques de fonctionnement, les exigences de conception et de structure et l'ordre des tests. Les trois courbes caractéristiques (B, C, D) des disjoncteurs fonctionnent de manière identique dans la plage de surcharge (<math> < 2,55 \times I_n </math>). La différence est visible dans la plage de surcharge supérieure à $3 \times I_n$ où les disjoncteurs de type B, C et D déclenchent respectivement pour un courant de $3 \dots 5 \times I_n$, $5 \dots 10 \times I_n$, $10 \dots 15 \times I_n$.

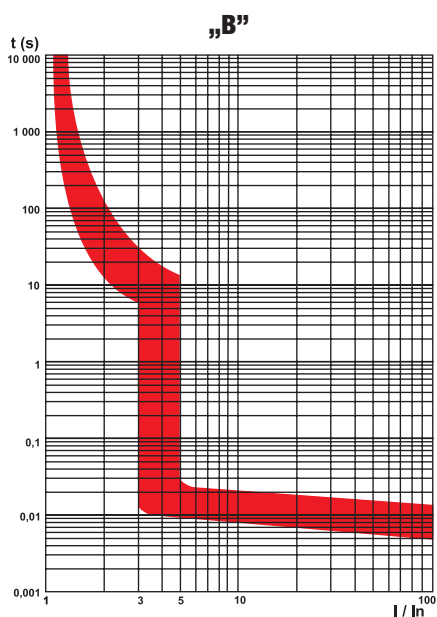

Pour un usage général - protection des équipements à faible courant de démarrage, des circuits des lampes à incandescence, des conducteurs.

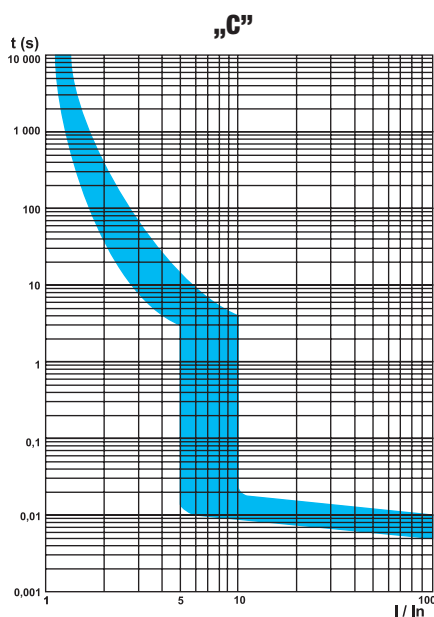

Pour un usage général - protection des machines, appareils électroménagers, des moteurs à faibles impulsions.

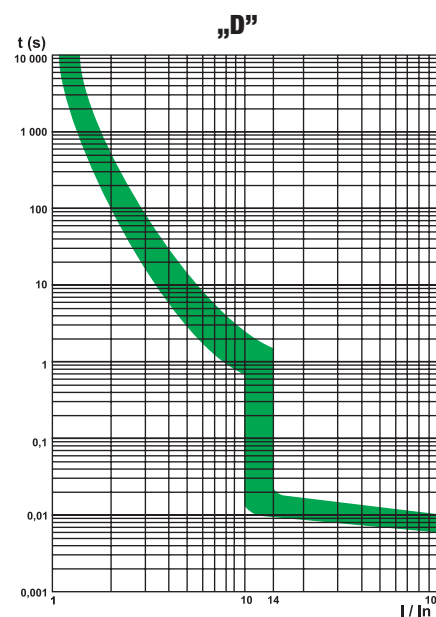

Protection des moteurs à fort courant de démarrage, transformateurs, consommateurs inductifs.

Données relatives à la température extérieure





Le courant maximal de charge autorisé des disjoncteurs diminue avec l'augmentation de la température ambiante. Si, par exemple, plusieurs disjoncteurs sont installés côte à côte dans une armoire de distribution, la hausse prévue de température dans l'armoire doit être prise en compte lors du choix des disjoncteurs. Ex.: Alors qu'un disjoncteur de courant nominal de 16 A ($I_n = 16$ A) a un courant maximal de charge de 17,9 A environ à 20 °C, cette valeur est à 40 °C égale au courant nominal de 16 A, toutefois, elle est de seulement 13,9 A à 60 °C.

Température de fonctionnement de référence des disjoncteurs: **40 °C.**

Courant maximal de charge autorisé (A)

I_n (A)	20 °C	30 °C	40 °C	50 °C	60 °C
2	2.18	2.08	2	1.9	1.8
4	4.52	4.24	4	3.72	3.44
6	6.48	6.24	6	5.76	5.46
10	11.4	10.7	10	9.2	8.4
16	17.9	16.9	16	15	13.9
20	22.2	21.2	20	18.8	17.6
25	27.7	26.5	25	23.5	21.7
32	35.2	33.6	32	30.4	28.4
40	44.4	42.4	40	37.5	34.8
50	56	53	50	46.5	43
63	71.8	67.4	63	57.9	52.9





Disjoncteurs à courant résiduel

TRACON		xP 	x17.5 	I_n (A)	I_{cn} EN60698	
EVOKE	B, C	2	1	6 – 32 A	6 kA	F/15.
EVOK	B, C	2	1	6 – 32 A	6 kA	F/16.
EVOKM	B, C	2	1	6 – 32 A	6 kA	F/16.
KVKE	B, C	2	1	6 – 32 A	6 kA	F/31.
KVK	B, C	2	2	6 – 32 A	3 kA	F/31.
KVKM	B, C	2	2	6 – 40 A	6 kA	F/32.

Les disjoncteurs à courant résiduel sont surtout destinés aux installations électriques des bâtiments pour la protection contre les chocs électriques des personnes, les surcharges et les courts-circuits. Ils conviennent particulièrement pour une utilisation dans les circuits électriques de locaux dans lesquels l'établissement d'une sécurité renforcée est souhaité. En raison de leurs petites dimensions, en cas d'une modification ultérieure des besoins, ils sont intégrables facilement en substitution de l'appareil de protection (disjoncteur) existant. Le transformateur de courant du disjoncteur c'est à dire le déclencheur rapide magnétique ainsi que le déclencheur de surcharge thermique bimétallique remplit les trois fonctions requises. Ce disjoncteur interrompt le circuit électrique du consommateur protégé aux deux pôles. Le contrôle du bon fonctionnement de la partie disjoncteur à courant résiduel de l'appareil a lieu en appuyant sur le bouton de test «T». Celui-ci doit être effectué tous les mois si possible. Pour assurer un bon fonctionnement, il convient de respecter les repères des bornes lors du branchement!



Interrupteurs automatiques à courant différentiel résiduel

TRACON		xP 	I_n (A)	$I_{\Delta n}$ (mA)	I_{cn} EN60698	
EVOV		2, 4	25, 40, 63, 80	30, 100, 300	6 kA	F/17.
RB		2, 4	25, 40, 63	30, 100, 300, 500	4,5 kA	F/32.
TFV		2, 4	16, 25, 40, 63	30, 100, 300	6 kA	F/33.
TFVH		4	80, 100, 125	30, 100, 300	6 kA	F/33.
EVOG		2, 4	25, 40, 63, 80	30, 100, 300	6 kA	F/18.
TFG		2, 4	16, 25, 40, 63	30, 100, 300	6 kA	F/34.
TFGA		–	16	30	6 kA	F/34.
TFIG		2, 4	16, 25, 40, 63, 80	30, 100, 300	10 kA	F/35.

TRACON	Description	EVOV	EVOG	RB	TFV	TFVH	TFG	TFIG
EDS-□, EDFK-□	Boîtes de distribution	✓	✓	✓	✓	✓	✓	✓
TFSS-□	Peignes de distributions standard	✓	✓	✓	✓	✓	✓	✓
TFSS-□V	Peignes de distribution à fourche	✓	✓	✓	✓	✓	✓	✓
TFSS-1CS	bornier à vis	✓	✓	✓	✓	✓	✓	–
35/7,5□SIN	Rails de montage selon la norme EN 50022	✓	✓	✓	✓	✓	✓	✓

Les interrupteurs à courant différentiel résiduel dans les circuits PE représentent le moyen le plus moderne de protection contre les contacts indirects voire, dans certains cas, contre les contacts directs. L'interrupteur est activé automatiquement lorsque, dans le réseau à protéger, la valeur du courant résiduel (ex.: défaut d'isolation, court-circuit de masse, etc.) atteint la valeur critique. Un fusible de sauvegarde doit être utilisé en cas de courant de court-circuit indépendant supérieur à 6000 A. Cette installation est recommandée et dans certains cas obligatoire, par exemple, en amont de branchements extérieurs, d'armoires de chantier, de bétonnières, de salles de bains avec bains à remous, etc..



FAMILLE DE PRODUITS MODULAIRES EVO



**Disjoncteurs,
6 kA-10 kA**



F/12

**Disjoncteurs,
1+N**



F/15

**Matériel de protec-
tion combiné**



F/15

**Disjoncteurs à
courant résiduel**



F/17

**Interrupteurs
isolants**



F/19

Commutateurs



F/20

**Interrupteur-section-
neur verrouillable**



F/21

**Voyants
lumineux**



F/21

**Bouton-poussoir
modulaire**



F/22

**Transformateur de
sécurité (sonnette)**



F/22

**Contacteur
d'installation**



F/23

**Réenclencheurs
automatiques**



F/24

Découvrez nos nouveautés dans la boutique en ligne.

Contacteur auxiliaire et d'alarme

230/400 V AC
 x5.000
 x4.000
IP 20
35x7.5
[mm²] 0,5-4
Ta -25..+55°C
 U_i 500 V
V0 UL94

Pictogrammes **F/0**

TRACON		I _n (A) 400 V AC	I _n (A) 230 V AC	I _n (A) 110 V DC	I _n (A) 48 V DC	I _n (A) 24 V DC
EVOZ-AUX11	EVOZ					
EVOH-AUX11	EVOH					
EVOTDA-AUX11	EVOTDA					
EVOZ-AL	EVOZ	3 A	6 A	1 A	2 A	4 A
EVOH-AL	EVOH					
EVOTDA-AL	EVOTDA					

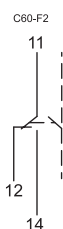
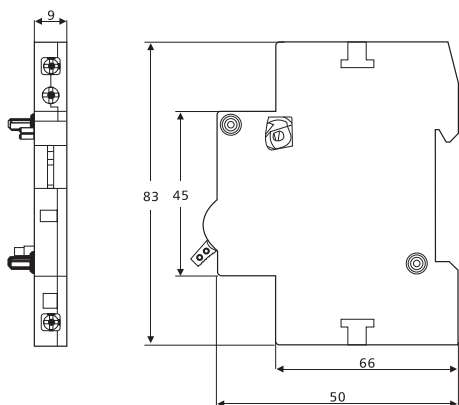

Bobine à émission, sous et sur-tension

230/400 V AC
 x4.000
 x3.000
IP 20
35x7.5
[mm²] 0,5-4
Ta -25..+55°C
 U_i 500 V
V0 UL94



TRACON		U _s		
EVOZ-SR*	EVOZ	110-415V AC / 110-220V DC	-	-
EVOH-SR*	EVOH	110-415V AC / 110-220V DC	-	-
EVOTDA-SR*	EVOTDA	110-415V AC / 110-220V DC	-	-
EVOZ-OVR	EVOZ	-	280V ± 5%	-
EVOZ-UVR	EVOZ	-	-	170V ± 5%
EVOH-OVR	EVOH	-	280V ± 5%	-
EVOH-UVR	EVOH	-	-	170V ± 5%
EVOTDA-OVR	EVOTDA	-	280V ± 5%	-
EVOTDA-UVR	EVOTDA	-	-	170V ± 5%

* Bobine à émission

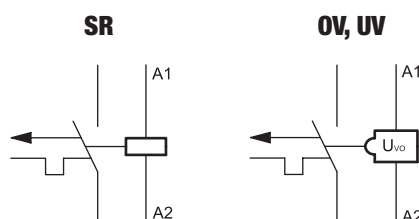
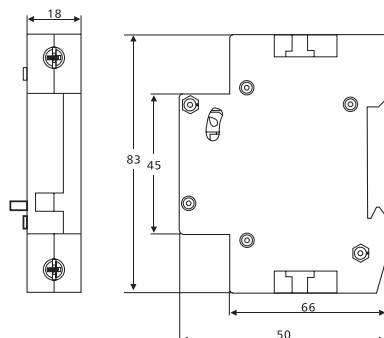

Disjoncteurs miniatures EVOZ

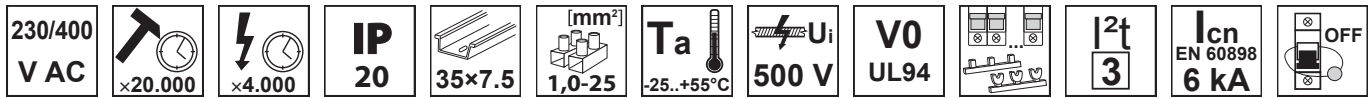

TRACON		I _n (A)
B	C	
EVOZ1B1	EVOZ1C1	1
EVOZ1B2	EVOZ1C2	2
EVOZ1B4	EVOZ1C4	4
EVOZ1B6	EVOZ1C6	6
EVOZ1B10	EVOZ1C10	10
EVOZ1B13	EVOZ1C13	13
EVOZ1B16	EVOZ1C16	16
EVOZ1B20	EVOZ1C20	20
EVOZ1B25	EVOZ1C25	25
EVOZ1B32	EVOZ1C32	32
EVOZ1B40	EVOZ1C40	40
EVOZ1B50	EVOZ1C50	50
EVOZ1B63	EVOZ1C63	63
<hr/>		
EVOZ2B1	EVOZ2C1	1
EVOZ2B2	EVOZ2C2	2
EVOZ2B4	EVOZ2C4	4
EVOZ2B6	EVOZ2C6	6
EVOZ2B10	EVOZ2C10	10
EVOZ2B13	EVOZ2C13	13
EVOZ2B16	EVOZ2C16	16
EVOZ2B20	EVOZ2C20	20
EVOZ2B25	EVOZ2C25	25
EVOZ2B32	EVOZ2C32	32
EVOZ2B40	EVOZ2C40	40
EVOZ2B50	EVOZ2C50	50
EVOZ2B63	EVOZ2C63	63

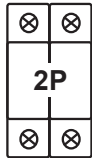

TRACON		I _n (A)
B	C	
EVOZ3B1	EVOZ3C1	1
EVOZ3B2	EVOZ3C2	2
EVOZ3B4	EVOZ3C4	4
EVOZ3B6	EVOZ3C6	6
EVOZ3B10	EVOZ3C10	10
EVOZ3B13	EVOZ3C13	13
EVOZ3B16	EVOZ3C16	16
EVOZ3B20	EVOZ3C20	20
EVOZ3B25	EVOZ3C25	25
EVOZ3B32	EVOZ3C32	32
EVOZ3B40	EVOZ3C40	40
EVOZ3B50	EVOZ3C50	50
EVOZ3B63	EVOZ3C63	63
<hr/>		
EVOZ4B1	EVOZ4C1	1
EVOZ4B2	EVOZ4C2	2
EVOZ4B4	EVOZ4C4	4
EVOZ4B6	EVOZ4C6	6
EVOZ4B10	EVOZ4C10	10
EVOZ4B13	EVOZ4C13	13
EVOZ4B16	EVOZ4C16	16
EVOZ4B20	EVOZ4C20	20
EVOZ4B25	EVOZ4C25	25
EVOZ4B32	EVOZ4C32	32
EVOZ4B40	EVOZ4C40	40
EVOZ4B50	EVOZ4C50	50
EVOZ4B63	EVOZ4C63	63

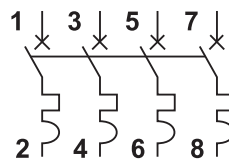
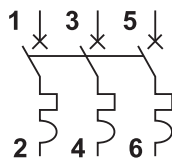
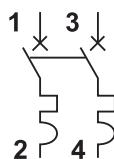
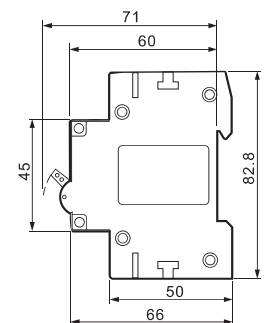
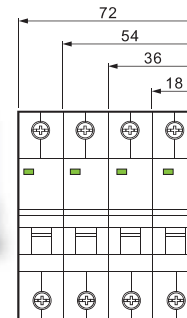
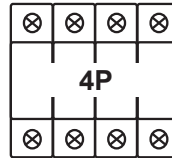
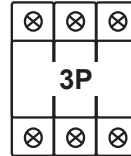

RELEVANT STANDARD
EN 60898-1

RELEVANT STANDARD
EN 60947-2

Disjoncteurs miniatures EVOTDA

230/400 V AC
 x20.000
 x6.000
IP 20
 35x7.5
 [mm²] 1,5-25
Ta -25..+55°C
 U_i 500 V
V0 UL94

I_{2t} 3
I_{cn} EN 60898 10 kA

TRACON		I _n (A)
TDA-1B-1	TDA-1C-1	1
TDA-1B-2	TDA-1C-2	2
TDA-1B-4	TDA-1C-4	4
TDA-1B-6	TDA-1C-6	6
TDA-1B-10	TDA-1C-10	10
TDA-1B-13	TDA-1C-13	13
TDA-1B-16	TDA-1C-16	16
TDA-1B-20	TDA-1C-20	20
TDA-1B-25	TDA-1C-25	25
TDA-1B-32	TDA-1C-32	32
TDA-1B-40	TDA-1C-40	40
TDA-1B-50	TDA-1C-50	50
TDA-1B-63	TDA-1C-63	63
<hr/>		
TDA-2B-1	TDA-2C-1	1
TDA-2B-2	TDA-2C-2	2
TDA-2B-4	TDA-2C-4	4
TDA-2B-6	TDA-2C-6	6
TDA-2B-10	TDA-2C-10	10
TDA-2B-13	TDA-2C-13	13
TDA-2B-16	TDA-2C-16	16
TDA-2B-20	TDA-2C-20	20
TDA-2B-25	TDA-2C-25	25
TDA-2B-32	TDA-2C-32	32
TDA-2B-40	TDA-2C-40	40
TDA-2B-50	TDA-2C-50	50
TDA-2B-63	TDA-2C-63	63

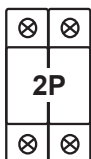

TRACON		I _n (A)
TDA-3B-1	TDA-3C-1	1
TDA-3B-2	TDA-3C-2	2
TDA-3B-4	TDA-3C-4	4
TDA-3B-6	TDA-3C-6	6
TDA-3B-10	TDA-3C-10	10
TDA-3B-13	TDA-3C-13	13
TDA-3B-16	TDA-3C-16	16
TDA-3B-20	TDA-3C-20	20
TDA-3B-25	TDA-3C-25	25
TDA-3B-32	TDA-3C-32	32
TDA-3B-40	TDA-3C-40	40
TDA-3B-50	TDA-3C-50	50
TDA-3B-63	TDA-3C-63	63
<hr/>		
TDA-4B-1	TDA-4C-1	1
TDA-4B-2	TDA-4C-2	2
TDA-4B-4	TDA-4C-4	4
TDA-4B-6	TDA-4C-6	6
TDA-4B-10	TDA-4C-10	10
TDA-4B-13	TDA-4C-13	13
TDA-4B-16	TDA-4C-16	16
TDA-4B-20	TDA-4C-20	20
TDA-4B-25	TDA-4C-25	25
TDA-4B-32	TDA-4C-32	32
TDA-4B-40	TDA-4C-40	40
TDA-4B-50	TDA-4C-50	50
TDA-4B-63	TDA-4C-63	63

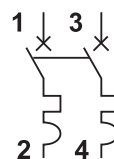
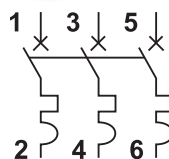
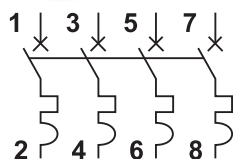
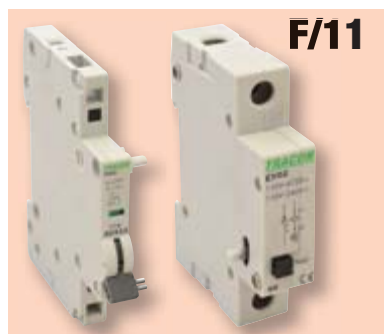
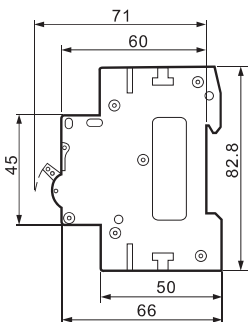
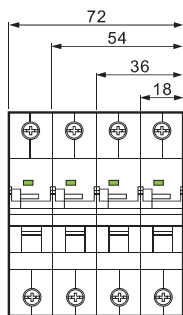
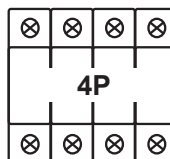
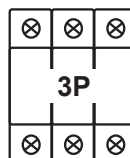

RELEVANT STANDARD
EN 60898

Pictogrammes **F/0**



Disjoncteurs miniatures à fort courant EVOH

230/400 V AC	$\times 20.000$	$\times 10.000$	IP 20	35x7.5	[mm ²] 16-50	Ta -25..+55°C	Ui 500 V	V0 UL94		12t 3	Icn EN 60898 10 kA	
-----------------	-----------------	-----------------	--------------	--------	--------------------------	----------------------	-----------------	----------------	--	--------------	---------------------------	--

TRACON		I_n (A)
	EVOH163	63
	EVOH180	80
	EVOH1100	100
	EVOH1125	125

TRACON		I_n (A)
	EVOH363	63
	EVOH380	80
	EVOH3100	100
	EVOH3125	125

TRACON		I_n (A)
	EVOH263	63
	EVOH280	80
	EVOH2100	100
	EVOH2125	125

TRACON		I_n (A)
	EVOH463	63
	EVOH480	80
	EVOH4100	100
	EVOH4125	125

TRACON		I_n (A)
	EVOH163	63
	EVOH180	80
	EVOH1100	100
	EVOH1125	125

TRACON		I_n (A)
	EVOH263	63
	EVOH280	80
	EVOH2100	100
	EVOH2125	125

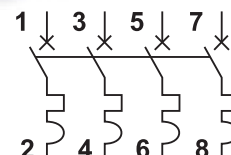
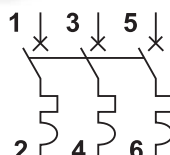

Caractéristiques de déclenchement

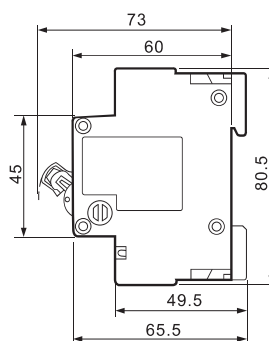
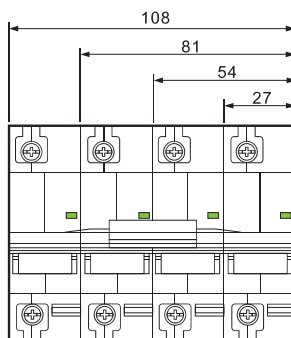
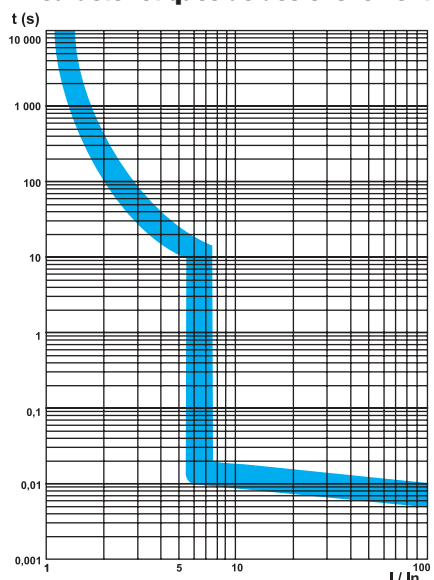

**RELEVANT STANDARD
EN 60898**



Disjoncteurs miniatures EVON

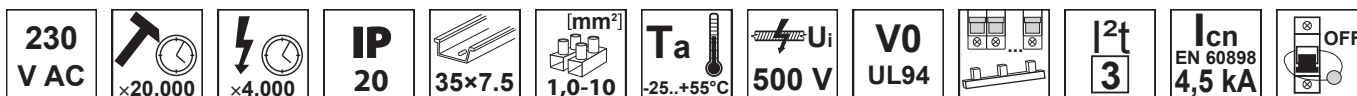

TRACON		I_n (A)

⊗	⊗
1P	N
⊗	⊗

EVONC6	6
EVONC10	10
EVONC16	16
EVONC20	20
EVONC25	25
EVONC32	32

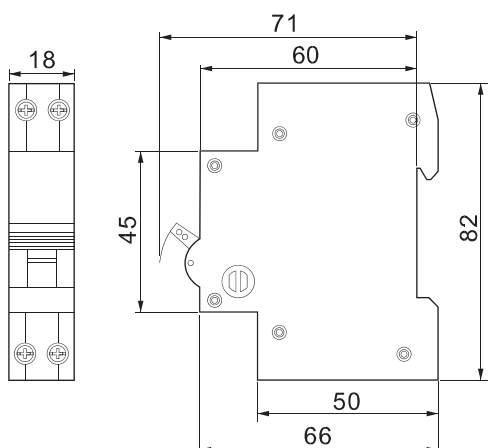
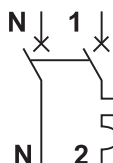

* Dispositif bipolaire qui dispose d'un pôle protégé (phase) et d'un pôle neutre commuté (N).

RELEVANT STANDARD
EN 60898-1

Pictogrammes **F/0**

Appareils combinés de protection EVOKE, 1 module de largeur

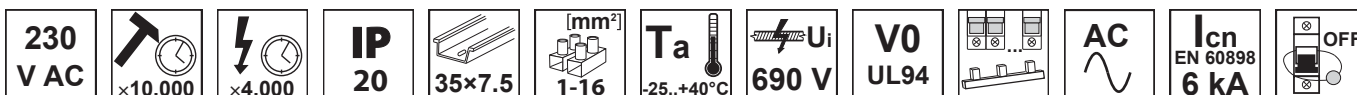

TRACON		I_n (A)	$I_{\Delta n}$ (mA)

⊗	⊗
2P	
⊗	⊗

EVOKEB603	EVOKEC603	6	30
EVOKEB1003	EVOKEC1003	10	30
EVOKEB1603	EVOKEC1603	16	30
EVOKEB2003	EVOKEC2003	20	30
EVOKEB2503	EVOKEC2503	25	30
EVOKEB3203	EVOKEC3203	32	30

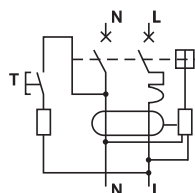

Caractéristique de déclenchement

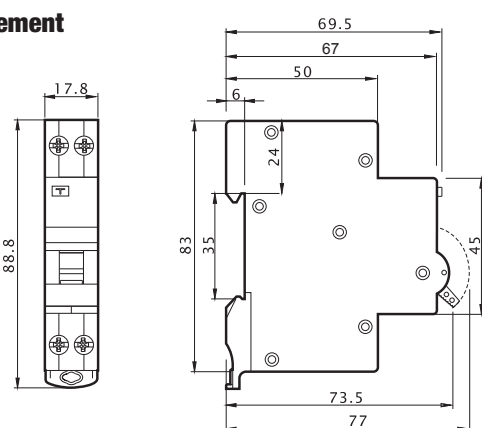
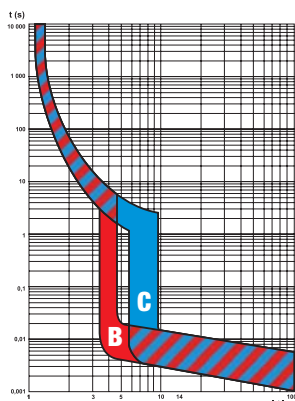

E3

RELEVANT STANDARD
EN 61009-1

Appareils combinés de protection EVOK

230 V AC
 $\times 10.000$
 $\times 4.000$
IP 20
35x7.5
[mm²] 1,5-25
Ta -25..+40°C
690 V
UL94
AC
Icn EN 60898 6 kA
OFF



Caractéristique de déclenchement

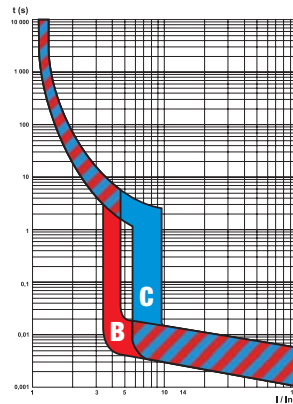

TRACON		In (A)	IΔn (mA)
B	C		
EVOK2B603	EVOK2C603	6	30
EVOK2B1003	EVOK2C1003	10	30
EVOK2B1603	EVOK2C1603	16	30
EVOK2B2003	EVOK2C2003	20	30
EVOK2B2503	EVOK2C2503	25	30
EVOK2B3203	EVOK2C3203	32	30
EVOK2B4003	EVOK2C4003	40	30

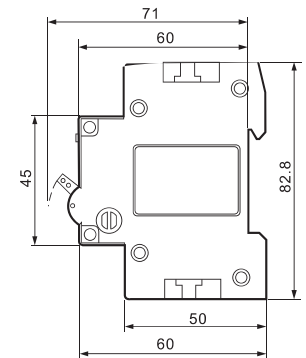
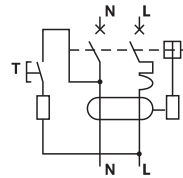
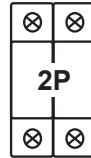

RELEVANT STANDARD EN 61009-1



Pictogrammes F/0

E3

Appareils combinés de protection, électromécanique EVOKM

230 V AC
 $\times 10.000$
 $\times 4.000$
IP 20
35x7.5
[mm²] 1,5-25
Ta -25..+55°C
690 V
UL94
AC
Icn EN 60898 6 kA
OFF



Caractéristique de déclenchement

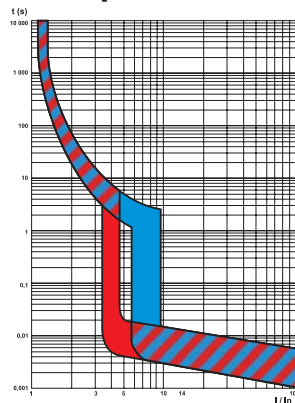

TRACON		In (A)	IΔn (mA)
B	C		
EVOKM2B603	EVOKM2C603	6	30
EVOKM2B1003	EVOKM2C1003	10	30
EVOKM2B1603	EVOKM2C1603	16	30
EVOKM2B2003	EVOKM2C2003	20	30
EVOKM2B2503	EVOKM2C2503	25	30
EVOKM2B3203	EVOKM2C3203	32	30
EVOKM2B4003	EVOKM2C4003	40	30
EVOKM2B5003	EVOKM2C5003	50	30
EVOKM2B6303	EVOKM2C6303	63	30

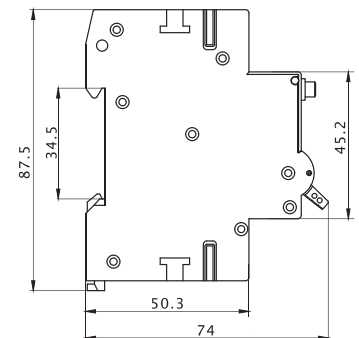
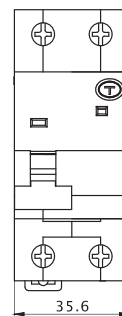
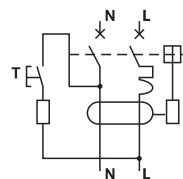
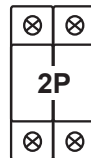

RELEVANT STANDARD EN 61009-1



Le disjoncteur à courant résiduel protège des chocs électriques même en cas de rupture du conducteur neutre!

Disjoncteurs à courant résiduel EVOV

230/400 V AC	x20.000	x10.000	IP 20	35x7.5	[mm ²] 2,5-25	Ta -25..+55°C	U_i 500 V	V0 UL94		AC 	I_{cn} EN 60898 6 kA	
-----------------	---------	---------	-----------------	--------	------------------------------	-------------------------	-------------------------------	-------------------	--	---------------	---	--

TRACON	I _n (A)	I _{Δn} (mA)
EVOV2P2503	25	30
EVOV2P4003	40	30
EVOV2P6303	63	30
EVOV2P8003	80	30
EVOV2P251	25	100
EVOV2P401	40	100
EVOV2P631	63	100
EVOV2P801	80	100
EVOV2P253	25	300
EVOV2P403	40	300
EVOV2P633	63	300
EVOV2P803	80	300
EVOV4P2503	25	30
EVOV4P4003	40	30
EVOV4P6303	63	30
EVOV4P8003	80	30
EVOV4P251	25	100
EVOV4P401	40	100
EVOV4P631	63	100
EVOV4P801	80	100
EVOV4P253	25	300
EVOV4P403	40	300
EVOV4P633	63	300
EVOV4P803	80	300

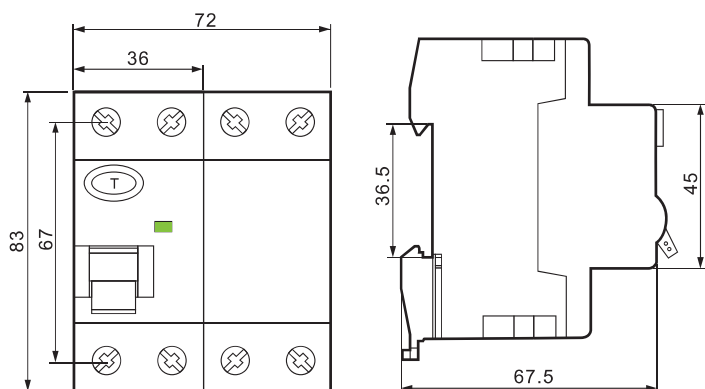
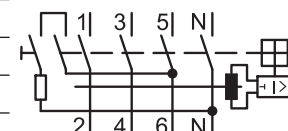
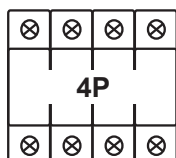
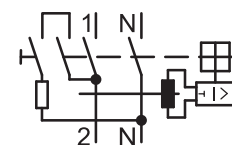
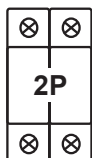

Pour réseaux à courant alternatif!

RELEVANT STANDARD
EN 61008-1



Disjoncteurs à courant résiduel EVOG

230/400 V AC	IP 20	35x7.5	[mm ²] 2,5-35	T _a -25...+55°C	U _i 500 V	V0 UL94		A, AC	I _{cn} EN 60898 6 kA	
-----------------	-----------------	--------	------------------------------	-------------------------------	-------------------------	-------------------	--	--------------	--	--

TRACON	I _n (A)	I _{Δn} (mA)
EVOG2P2503	25	30
EVOG2P4003	40	30
EVOG2P6303	63	30
EVOG2P8003	80	30
EVOG2P251	25	100
EVOG2P401	40	100
EVOG2P631	63	100
EVOG2P801	80	100
EVOG2P253	25	300
EVOG2P403	40	300
EVOG2P633	63	300
EVOG2P803	80	300
EVOG4P2503	25	30
EVOG4P4003	40	30
EVOG4P6303	63	30
EVOG4P8003	80	30
EVOG4P251	25	100
EVOG4P401	40	100
EVOG4P631	63	100
EVOG4P801	80	100
EVOG4P253	25	300
EVOG4P403	40	300
EVOG4P633	63	300
EVOG4P803	80	300

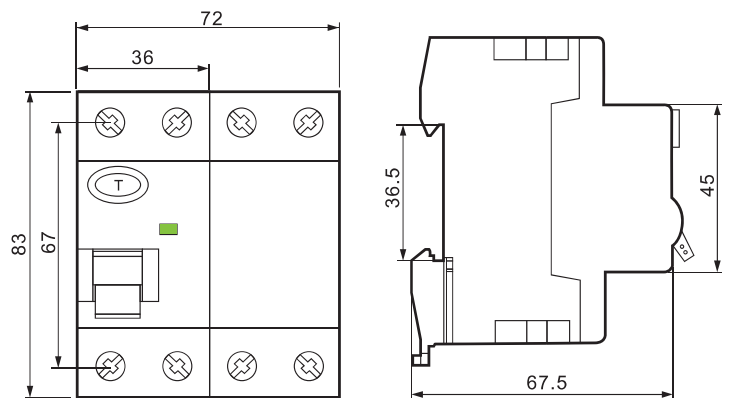
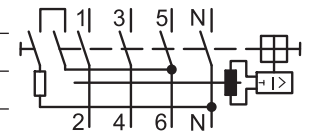
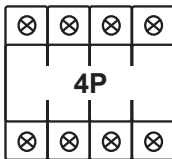
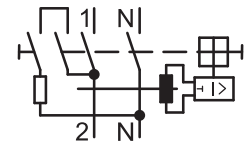
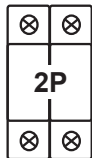

Pour réseaux à courant alternatif et continu pulsé!



RELEVANT STANDARD
EN 61008-1



J/10 - J/25

Interrupteurs d'isolation EVOTIK

	230/400 V AC			IP 20		Ta -25..+55°C		U_{imp} 6 kV	
--	---------------------	--	--	--------------	--	----------------------	--	-----------------------------	--

	TRACON	I _n (A)	mm ²
	TIK1-20	20	16-50
	TIK1-25	25	
	TIK1-32	32	
	TIK1-40	40	
	TIK1-63	63	
	TIK1-80	80	
	TIK1-100	100	
	TIK1-125	125	16-50
	TIK2-20	20	
	TIK2-25	25	
	TIK2-32	32	
	TIK2-40	40	
	TIK2-63	63	
	TIK2-80	80	
	TIK2-100	100	
	TIK2-125	125	

	TRACON	I _n (A)	mm ²
	TIK3-20	20	16-50
	TIK3-25	25	
	TIK3-32	32	
	TIK3-40	40	
	TIK3-63	63	
	TIK3-80	80	
	TIK3-100	100	
	TIK3-125	125	16-50
	TIK4-20	20	
	TIK4-25	25	
	TIK4-32	32	
	TIK4-40	40	
	TIK4-63	63	
	TIK4-80	80	
	TIK4-100	100	
	TIK4-125	125	

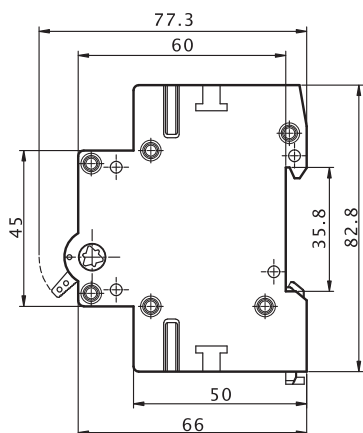
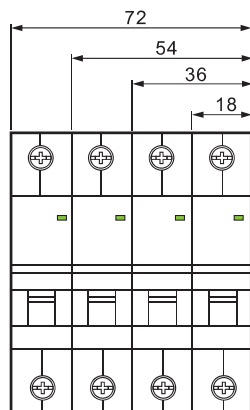
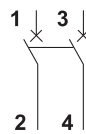
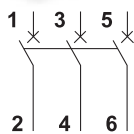
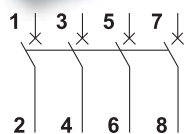

RELEVANT STANDARD EN 60947-3



F/21

Commutateurs modulaire EVOSVK

230/400 V AC	x30.000	x10.000	IP 20	35x7.5	[mm ²] 1-16	Ta -25..+55°C	U_i 690 V	V0 UL94		U_{imp} 6 kV	1 0 2
-----------------	---------	---------	-----------------	--------	----------------------------	-------------------------	-------------------------------	-------------------	--	--------------------------------	-------

TRACON	I _n (A)
--------	-----------------------



SVK1-16	16
SVK1-32	32
SVK1-63	63

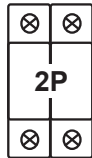

SVK2-16	16
SVK2-32	32
SVK2-63	63

TRACON	I _n (A)
--------	-----------------------



SVK3-16	16
SVK3-32	32
SVK3-63	63

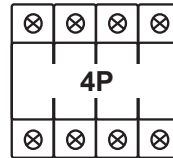

SVK4-16	16
SVK4-32	32
SVK4-63	63

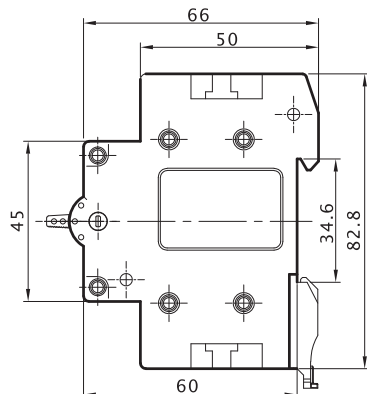
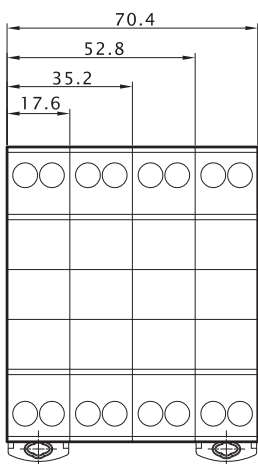
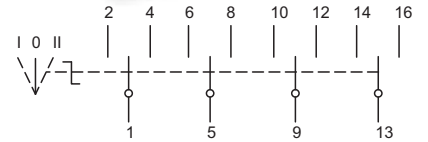
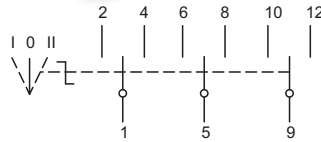
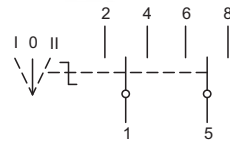
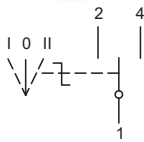



RELEVANT STANDARD
EN 60947-3

RELEVANT STANDARD
EN 60669-1

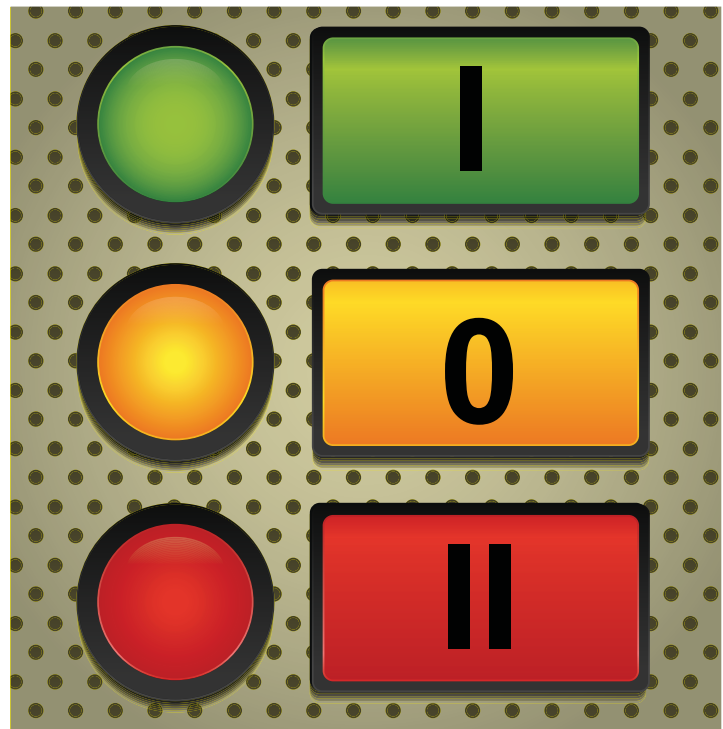
TÜV MEEI TEST DOCUMENTATION
28211822 001



Interrupteurs-sectionneurs verrouillables EVOMS

230 V AC
IP 20
35x7.5
Ta -25..+55°C
Ui 800 V



 Pictogrammes **F/0**

TRACON	Ith (40 °C)	A (mm)	B (mm)	C (mm)	D (mm)	E (mm)	mm ²
EVOMS16/3	16A/3P						
EVOMS20/3	20A/3P	73,3	81	65,5	75,5	36,5	1,5-16
EVOMS25/3	25A/3P						
EVOMS40/3	40A/3P						
EVOMS80/3	80A/3P						
EVOMS100/3	100A/3P	88	97,5	76,5	93,5	52	25-50
EVOMS125/3	125A/3P						

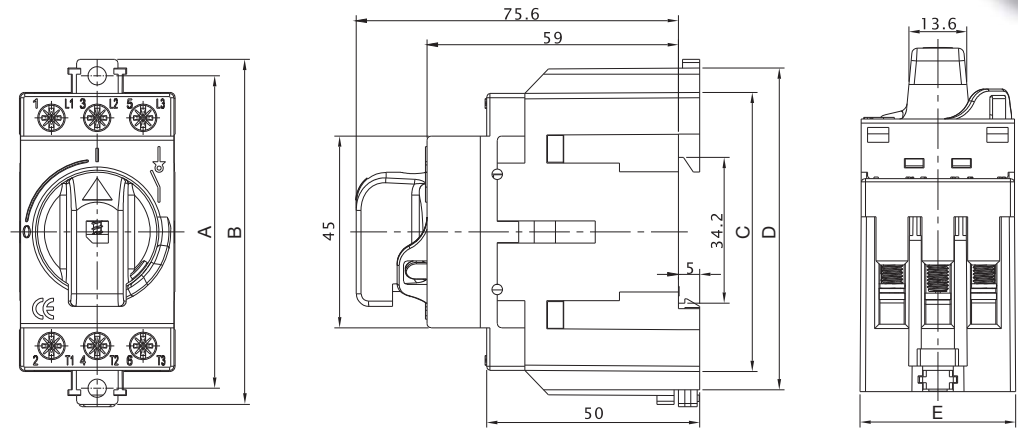

EVOMS63 EVOMS16



RELEVANT STANDARD
EN 60947-3

Voyants lumineux EVOSLJL

Pm 0,8 VA
20.000 [h]
IP 20
1-25 [mm²]
35x7.5
Ta -25..+55°C

 Pictogrammes **F/0**

TRACON	Color	Un	LED
SLJL-AC230-P	Red	230 V AC	× 1 LED
SLJL-AC230-Z	Green	230 V AC	× 1 LED
SLJL-AC230-S	Yellow	230 V AC	× 1 LED
SLJL-AC230-F	White	230 V AC	× 1 LED
SLJL-AC230-K	Blue	230 V AC	× 1 LED
SLJL-AC24-P	Red	24 V AC	× 1 LED
SLJL-AC24-Z	Green	24 V AC	× 1 LED
SLJL-AC24-S	Yellow	24 V AC	× 1 LED
SLJL-AC24-F	White	24 V AC	× 1 LED
SLJL-AC24-K	Blue	24 V AC	× 1 LED
SLJL-AC230-SZP	Red, Green, Yellow	3×230 V AC	× 3 LED
SLJL-DC220-P	Red	220 V DC	× 1 LED
SLJL-DC220-Z	Green	220 V DC	× 1 LED
SLJL-DC220-S	Yellow	220 V DC	× 1 LED
SLJL-DC220-F	White	220 V DC	× 1 LED
SLJL-DC220-K	Blue	220 V DC	× 1 LED
SLJL-DC24-P	Red	24 V DC	× 1 LED
SLJL-DC24-Z	Green	24 V DC	× 1 LED
SLJL-DC24-S	Yellow	24 V DC	× 1 LED
SLJL-DC24-F	White	24 V DC	× 1 LED
SLJL-DC24-K	Blue	24 V DC	× 1 LED

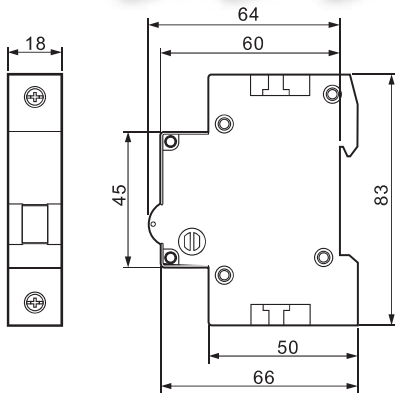

RELEVANT STANDARD
EN 62094-1
EN 60947-5

Boutons-poussoir modulaires EVOP

230 V AC
 $\times 250.000$
 $\times 10.000$
IP 20
35x7.5
[mm²] 1-10
Ta -5..+55 °C
500 V U_i
V0 UL94

Pictogrammes **F/O**



EVOPS

EVOPB2

EVOPSL

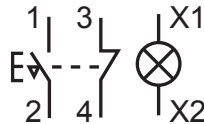
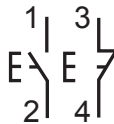
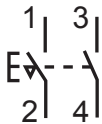

TRACON	I _{th}	I _e (AC-14) (230V AC)	NC NO
EVOPS	16A	6A	2NO
EVOPB2	16A	6A	1NO+1NC
EVOPSL	16A	6A	1NO+1NC

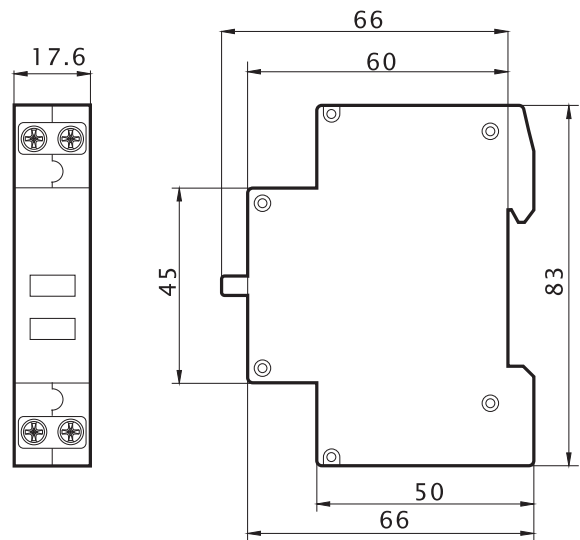

RELEVANT STANDARD
EN 60947-5-1

Transformateurs de sécurité (sonnette) EVOBT

IP 20
35x7.5
[mm²] 1,5-30
Ta -25..+55 °C
500 V U_i
V0 UL94

Pictogrammes **F/O**



EVOBT15/1

EVOBT30/1



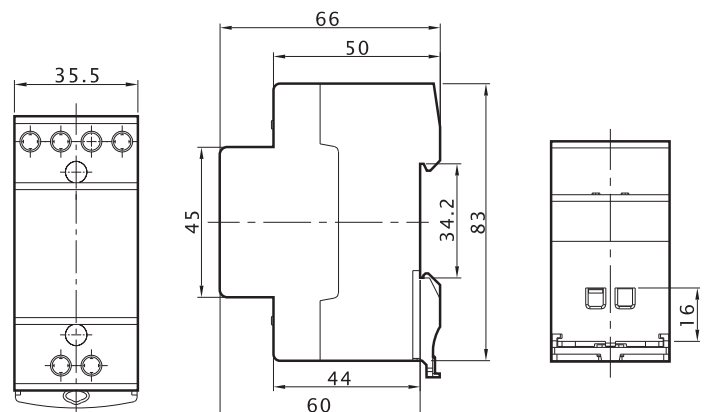



TRACON	P _s	U _{pr}	U _{sec}	I _{sec}
EVOBT15/1	max. 14 VA	230V AC	4-8-12V AC	1,15 A
EVOBT24/1	max. 37 VA		12-24V AC	1,55 A
EVOBT30/1	max. 37 VA		12-12-24V AC	1,55 A





RELEVANT STANDARD
EN 60947-5-1

RELEVANT STANDARD
EN 61558-2-8

Contacteurs d'installation EVOHK

230/400 V AC	 $\times 2.000.000$	 $\times 125.000$	IP 20	 35x7.5	 [mm ²] 1,5-35	 T_a -5...+55 °C	 U_i 500 V	V0 UL94	 ON-OFF-ON... sc/h $\times 360$	U_{imp} 4 kV
-----------------	--	--	--------------	--	--	---	---	-------------------	--	--------------------------------

TRACON	U _m	I _n (A)	W (mm)	P _e (kW)				P _s		
				AC1 / AC7a 230V	AC3 / AC7b 230V	AC1 / AC7a 400V	AC3 / AC7b 400V			
EVOHK2-25	230 V AC	25	17,5	5	1,5	-	-	1,35 W	20A gG	2 × NO
EVOHK2-25-24	24 V AC	25	17,5	5	1,5	-	-	1,35 W	20A gG	2 × NO
EVOHK2-25V	230 V AC	25	17,5	5	1,5	-	-	1,35 W	20A gG	1 × NO+1 × NC
EVOHK2-40	230 V AC	40	35,4	9	2,2	-	-	1,55 W	32A gG	2 × NO
EVOHK2-63	230 V AC	63	35,4	11,6	3,3	-	-	1,55 W	50A gG	2 × NO
EVOHK2-80	230 V AC	80	54	16	5,5	-	-	1,55 W	63A gG	2 × NO
EVOHK2-100	230 V AC	100	54	19	6	-	-	1,55 W	80A gG	2 × NO
EVOHK4-25	230 V AC	25	35	5	1,5	16	4	1,35 W	20A gG	4 × NO
EVOHK4-25-24	24 V AC	25	35	5	1,5	16	4	1,35 W	20A gG	4 × NO
EVOHK4-40	230 V AC	40	53,3	9	2,2	27,5	12,5	1,55 W	32A gG	4 × NO
EVOHK4-63	230 V AC	63	53,3	11,6	3,3	40	15	1,55 W	50A gG	4 × NO
EVOHK4-80	230 V AC	80	108	16	5,5	50	18,5	1,55 W	63A gG	4 × NO
EVOHK4-100	230 V AC	100	108	19	6	60	22	1,55 W	80A gG	4 × NO

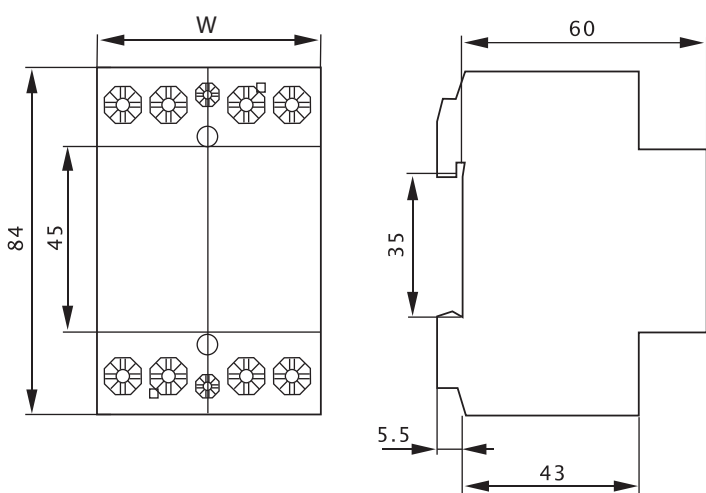

RELEVANT STANDARD
EN 60947-4-1

RELEVANT STANDARD
EN 61095

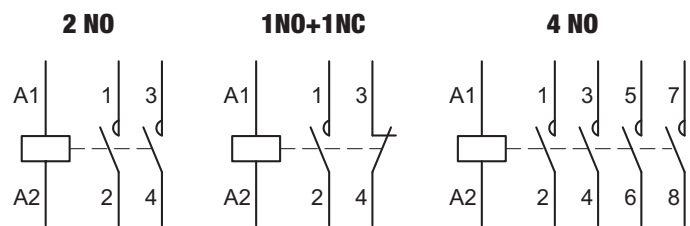

SCANNEZ LE CODE QR!

- Découvrez nos toutes dernières nouveautés
- Soyez à la pointe de l'info!

Notre gamme de produit évolue de jour en jour!
Notre catalogue présente notre collection de produits
à octobre 2017. Pour les toutes dernières
informations, visitez notre site!

Réenclencheurs automatiques sous et sur-tension

32 A gG	230/400 V AC	x4.000	IP 20	35x7.5	[mm ²] 1,5-25	Ta -20..+55°C	U_i 500 V	
---------	--------------	--------	--------------	--------	---------------------------	----------------------	----------------------------	--

Pictogrammes F/0

TRACON	2P	4P
	EVOU02	EVOU04
Tension nominale	230 V AC	230 V AC (L-N)
Fréquence nominale	50 Hz	
Intensité nominale	40 A (AC 1)	
Puissance consommée	AC max. 3 VA	
Niveau supérieur de protection	265 V (fix)	265 V (L-N) (fix)
Niveau supérieur de réenclenchement	257 V (fix)	257 V (L-N) (fix)
Niveau inférieur de protection	175 V (fix)	175 V (L-N) (fix)
Niveau inférieur de réenclenchement	180 V (fix)	180 V (L-N) (fix)
Temps de commutation	1 s	
Retard de commutation	2 s	
Temps de réenclenchement	30 s	
Précision des mesures	≤1%	
Masse	120 g	250 g



EVOU02



EVOU04

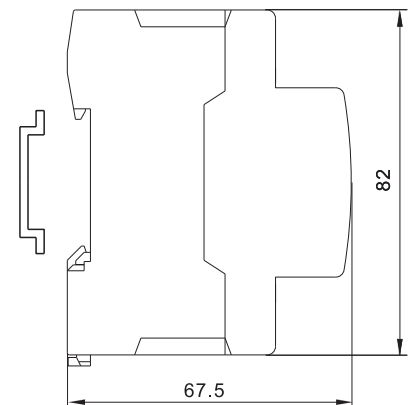
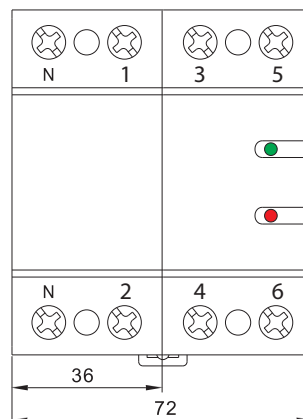

- Protection contre les sous et sur-tensions pour appareils domestiques.
- Se réenclenche automatiquement après rétablissement du courant.
- Indication du statut par diode LED

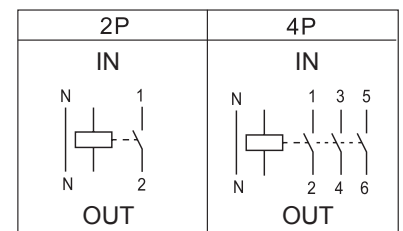
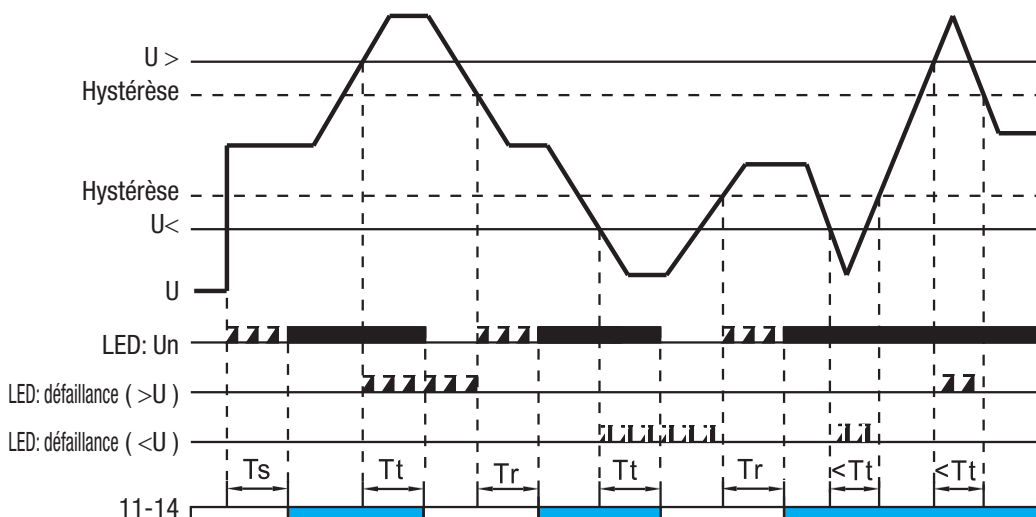

Ts : Temps de reprise d'opération
 Tt : Retard de désenclenchement
 Tr : temps de réinitialisation



Accessoires

230/400 V AC	x6.000	x5.000	IP 20	35x7.5	[mm ²] 1,5-25	Ta -25..+55°C	U _i 500 V	V0 UL94
-----------------	--------	--------	--------------	--------	------------------------------	----------------	-------------------------	-------------------

Pictogrammes F/0

TRACON			I_n (A)	I_n (A)	I_n (A)	I_n (A)	I_n (A)
			(415 V AC)	(240 V AC)	(125 V DC)	(48 V DC)	(24 V DC)
TDZ-F2		TDZ	3 A	6 A	1 A	2 A	4 A

Indique si le contact du disjoncteur est activé ou non.



Déclencheur à courant de travail (shunt)

230/400 V AC	x6.000	x4.000	IP 20	35x7.5	[mm ²] 1,5-25	Ta -25..+55°C	U _i 500 V	V0 UL94
-----------------	--------	--------	--------------	--------	------------------------------	----------------	-------------------------	-------------------

Pictogrammes F/0

TRACON			U_s
			110-415 V AC / 110-220 V DC
C60-S2		TDZ	

Il déclenche le disjoncteur par application par impulsion d'une tension de commande et peut être donc mis en œuvre pour le déclenchement à distance. En cas de déclenchement, le bouton de réarmement ressort. Il faut l'enfoncer pour réactiver le disjoncteur. Attention: La bobine de commande ne doit pas rester sous tension plus de 10 s!

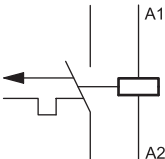

Déclencheur à minimum et maximum de tension

230/400 V AC	x6.000	x4.000	IP 20	35x7.5	[mm ²] 1,5-25	Ta -25..+55°C	U _i 500 V	V0 UL94
-----------------	--------	--------	--------------	--------	------------------------------	----------------	-------------------------	-------------------

Pictogrammes F/0

TRACON			U_{up}	U_{down}
			280 V ± 5 %	170 V ± 5 %
C60-U2/02		TDZ		

Il déclenche le disjoncteur si la tension du réseau est hors de la plage de fonctionnement spécifiée. Il protège donc les équipements sensibles des effets indésirables dus aux fluctuations de tension. Le disjoncteur ne peut être activé que si la valeur de la tension parvenant aux bornes du déclencheur est dans la plage de fonctionnement (170 V - 280 V). En cas de déclenchement, le bouton de réarmement ressort. Il faut l'enfoncer pour réactiver le disjoncteur.

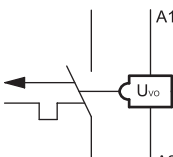
Verrouilleur pour dispositifs de protection modulaires

L'utilisation de ce verrou pour dispositifs de protection modulaires permet de sécuriser le levier en position «OFF» au moyen d'un cadenas. Le verrou est destiné aux appareils à leviers de commande de 8 à 10 mm de large disposant de deux orifices de 1 à 1,5 mm de diamètre situés au sommet de la partie archée du levier pour fixer le verrou.

Le diamètre maximal de l'arceau du cadenas: 8 mm. L'utilisation du cadenas en position «ON» est interdite!

TRACON



MDL

MB, RB, TDZ, TDA, KVKM, KVK, KVKVE, TFG, TFIG, TFV, TIK, SVK



Disjoncteurs DPN (1+N pôle)

230/400
V AC

x20.000

x6.000

IP
20

35x7.5

[mm²]
1,5-25

Ta
-25..+55°C

U_i
500 V

V0
UL94



I_{2t}
3

I_{cn}
EN 60898
4,5 kA

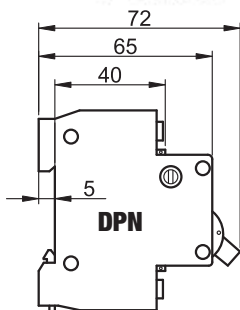
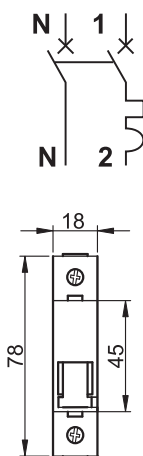

TRACON



I_n
(A)

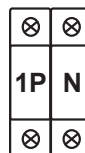

DPN-C-6	6
DPN-C-10	10
DPN-C-13	13
DPN-C-16	16
DPN-C-20	20
DPN-C-25	25
DPN-C-32	32

* Dispositif bipolaire qui dispose d'un pôle protégé (phase) et d'un pôle neutre commuté (N).

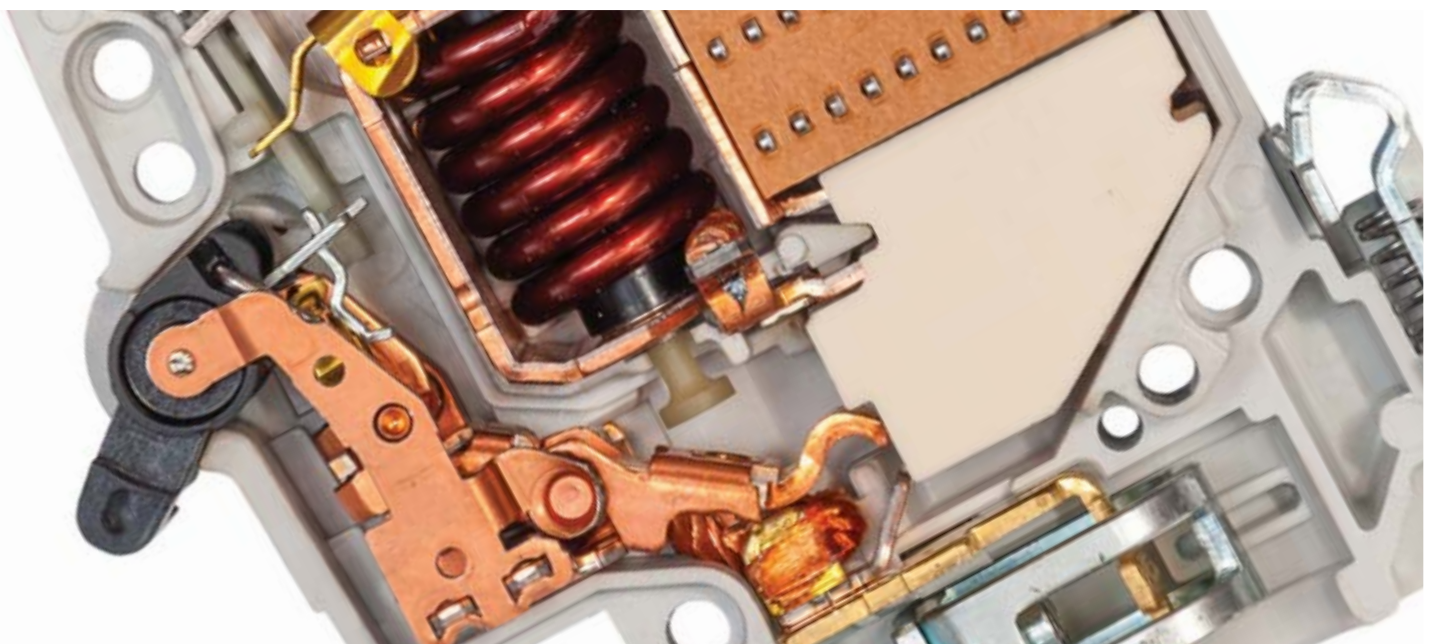

Disjoncteurs MB

230/400 V AC	x20.000	x6.000	IP 20	35x7.5	[mm ²] 1,5-25	Ta -25..+55°C	U_i 500 V	V0 UL94		12t 3	I_{cn} EN 60898 4,5 kA	
-----------------	---------	--------	-----------------	--------	------------------------------	-------------------------	-------------------------------	-------------------	--	-----------------	---	--

TRACON		I _n (A)
MB-1B-6	MB-1C-6	6
MB-1B-10	MB-1C-10	10
MB-1B-13	MB-1C-13	13
MB-1B-16	MB-1C-16	16
MB-1B-20	MB-1C-20	20
MB-1B-25	MB-1C-25	25
MB-1B-32	MB-1C-32	32
MB-1B-40	MB-1C-40	40
MB-1B-50	MB-1C-50	50
MB-1B-63	MB-1C-63	63
MB-2B-6	MB-2C-6	6
MB-2B-10	MB-2C-10	10
MB-2B-13	MB-2C-13	13
MB-2B-16	MB-2C-16	16
MB-2B-20	MB-2C-20	20
MB-2B-25	MB-2C-25	25
MB-2B-32	MB-2C-32	32
MB-2B-40	MB-2C-40	40
MB-2B-50	MB-2C-50	50
MB-2B-63	MB-2C-63	63

TRACON		I _n (A)
MB-3B-6	MB-3C-6	6
MB-3B-10	MB-3C-10	10
MB-3B-13	MB-3C-13	13
MB-3B-16	MB-3C-16	16
MB-3B-20	MB-3C-20	20
MB-3B-25	MB-3C-25	25
MB-3B-32	MB-3C-32	32
MB-3B-40	MB-3C-40	40
MB-3B-50	MB-3C-50	50
MB-3B-63	MB-3C-63	63
-	MB-4C-10	10
-	MB-4C-16	16
-	MB-4C-20	20
-	MB-4C-25	25
-	MB-4C-32	32
-	MB-4C-40	40
-	MB-4C-50	50
-	MB-4C-63	63

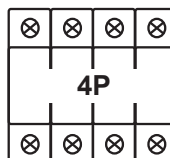
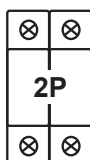
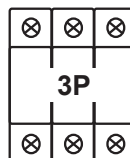
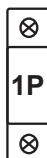



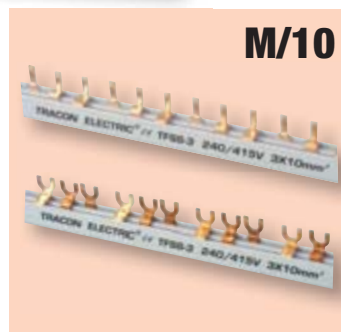
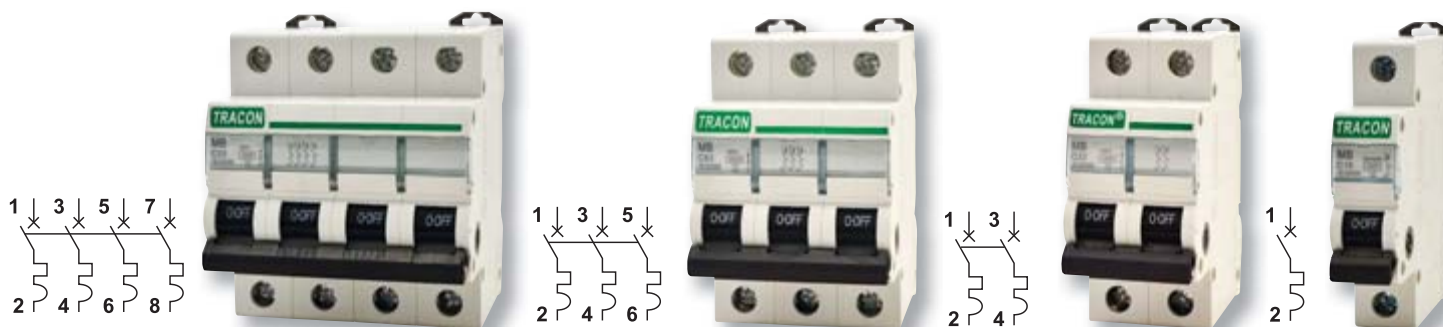
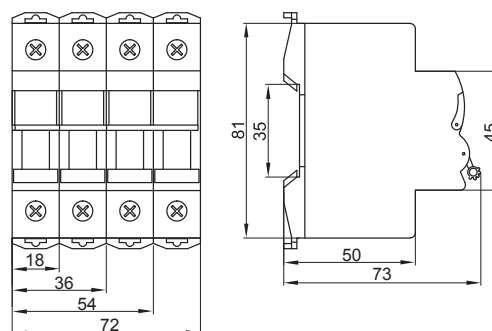

RELEVANT STANDARD
EN 60898

TÜV MEEI TEST DOCUMENTATION
03401-2014183F



Disjoncteurs TDZ

230/400 V AC
  x20.000
  x6.000
 IP 20
 35x7.5
 [mm²] 1,5-25
 Ta -25..+55°C
  U_i 500 V
 V0 UL94
 
 I_{2t} 3
 I_{cn} EN 60898 6 kA
  OFF

TRACON				I _n (A)
B	C	D		
TDZ-1B-1	TDZ-1C-1	TDZ-1D-1		1
TDZ-1B-2	TDZ-1C-2	TDZ-1D-2		2
TDZ-1B-4	TDZ-1C-4	TDZ-1D-4		4
TDZ-1B-6	TDZ-1C-6	TDZ-1D-6		6
TDZ-1B-10	TDZ-1C-10	TDZ-1D-10		10
TDZ-1B-13	TDZ-1C-13	TDZ-1D-13		13
TDZ-1B-16	TDZ-1C-16	TDZ-1D-16		16
TDZ-1B-20	TDZ-1C-20	TDZ-1D-20		20
TDZ-1B-25	TDZ-1C-25	TDZ-1D-25		25
TDZ-1B-32	TDZ-1C-32	TDZ-1D-32		32
TDZ-1B-40	TDZ-1C-40	TDZ-1D-40		40
TDZ-1B-50	TDZ-1C-50	TDZ-1D-50		50
TDZ-1B-63	TDZ-1C-63	TDZ-1D-63		63
TDZ-2B-1	TDZ-2C-1	TDZ-2D-1		1
TDZ-2B-2	TDZ-2C-2	TDZ-2D-2		2
TDZ-2B-4	TDZ-2C-4	TDZ-2D-4		4
TDZ-2B-6	TDZ-2C-6	TDZ-2D-6		6
TDZ-2B-10	TDZ-2C-10	TDZ-2D-10		10
TDZ-2B-13	TDZ-2C-13	TDZ-2D-13		13
TDZ-2B-16	TDZ-2C-16	TDZ-2D-16		16
TDZ-2B-20	TDZ-2C-20	TDZ-2D-20		20
TDZ-2B-25	TDZ-2C-25	TDZ-2D-25		25
TDZ-2B-32	TDZ-2C-32	TDZ-2D-32		32
TDZ-2B-40	TDZ-2C-40	TDZ-2D-40		40
TDZ-2B-50	TDZ-2C-50	TDZ-2D-50		50
TDZ-2B-63	TDZ-2C-63	TDZ-2D-63		63

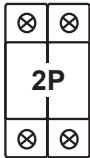

TRACON				I _n (A)
B	C	D		
TDZ-3B-1	TDZ-3C-1	TDZ-3D-1		1
TDZ-3B-2	TDZ-3C-2	TDZ-3D-2		2
TDZ-3B-4	TDZ-3C-4	TDZ-3D-4		4
TDZ-3B-6	TDZ-3C-6	TDZ-3D-6		6
TDZ-3B-10	TDZ-3C-10	TDZ-3D-10		10
TDZ-3B-13	TDZ-3C-13	TDZ-3D-13		13
TDZ-3B-16	TDZ-3C-16	TDZ-3D-16		16
TDZ-3B-20	TDZ-3C-20	TDZ-3D-20		20
TDZ-3B-25	TDZ-3C-25	TDZ-3D-25		25
TDZ-3B-32	TDZ-3C-32	TDZ-3D-32		32
TDZ-3B-40	TDZ-3C-40	TDZ-3D-40		40
TDZ-3B-50	TDZ-3C-50	TDZ-3D-50		50
TDZ-3B-63	TDZ-3C-63	TDZ-3D-63		63
TDZ-4B-1	TDZ-4C-1	TDZ-4D-1		1
TDZ-4B-2	TDZ-4C-2	TDZ-4D-2		2
TDZ-4B-4	TDZ-4C-4	TDZ-4D-4		4
TDZ-4B-6	TDZ-4C-6	TDZ-4D-6		6
TDZ-4B-10	TDZ-4C-10	TDZ-4D-10		10
TDZ-4B-13	TDZ-4C-13	TDZ-4D-13		13
TDZ-4B-16	TDZ-4C-16	TDZ-4D-16		16
TDZ-4B-20	TDZ-4C-20	TDZ-4D-20		20
TDZ-4B-25	TDZ-4C-25	TDZ-4D-25		25
TDZ-4B-32	TDZ-4C-32	TDZ-4D-32		32
TDZ-4B-40	TDZ-4C-40	TDZ-4D-40		40
TDZ-4B-50	TDZ-4C-50	TDZ-4D-50		50
TDZ-4B-63	TDZ-4C-63	TDZ-4D-63		63

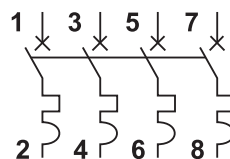
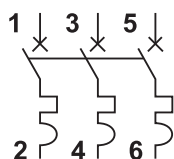
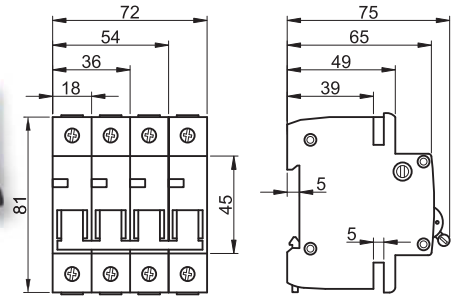
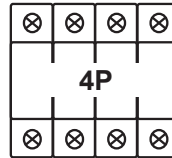

RELEVANT STANDARD
EN 60898



Disjoncteurs CC pour réseaux électriques CC



TRACON	U_i	U_e (6kV)	U_e (10kV)	I_{cu} EN 60898-2	I_{cu} EN 60947-2
DC-1C-..	500 V DC	125 V, 250 V	110 V, 220 V	6 kA	10 kA
DC-2C-..	500 V DC	250 V, 500 V	220 V, 440 V	6 kA	10 kA
DC-3C-..	1000 V DC	375 V, 750 V	330 V, 660 V	6 kA	10 kA
DC-4C-..	1000 V DC	500 V, 1000 V	440 V, 880 V	6 kA	10 kA

TRACON	I_n (A)
DC-1C-6	6
DC-1C-10	10
DC-1C-13	13
DC-1C-16	16
DC-1C-20	20
DC-1C-25	25
DC-1C-32	32
DC-1C-40	40
DC-1C-50	50
DC-1C-63	63
DC-2C-6	6
DC-2C-10	10
DC-2C-13	13
DC-2C-16	16
DC-2C-20	20
DC-2C-25	25
DC-2C-32	32
DC-2C-40	40
DC-2C-50	50
DC-2C-63	63

TRACON	I_n (A)
DC-3C-6	6
DC-3C-10	10
DC-3C-13	13
DC-3C-16	16
DC-3C-20	20
DC-3C-25	25
DC-3C-32	32
DC-3C-40	40
DC-3C-50	50
DC-3C-63	63
DC-4C-6	6
DC-4C-10	10
DC-4C-13	13
DC-4C-16	16
DC-4C-20	20
DC-4C-25	25
DC-4C-32	32
DC-4C-40	40
DC-4C-50	50
DC-4C-63	63

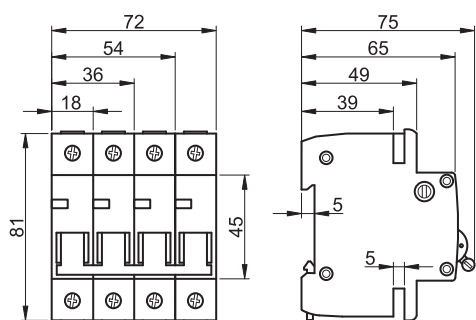
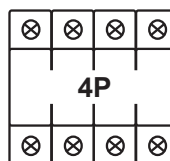
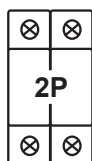
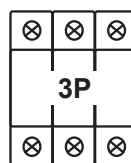
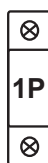

TÜV MEEI TEST DOCUMENTATION
28216230 001

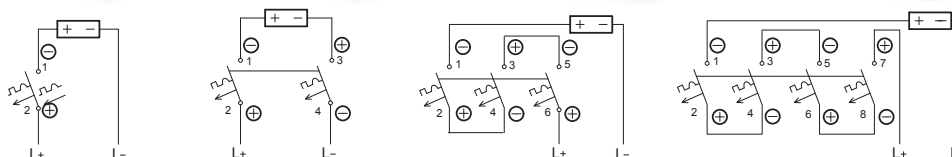

SCANNEZ LE CODE QR!

- Découvrez nos toutes dernières nouveautés
- Soyez à la pointe de l'info!

Notre gamme de produit évolue de jour en jour!
Notre catalogue présente notre collection de produits
à octobre 2017. Pour les toutes dernières
informations, visitez notre site!

Disjoncteurs pour la protection contre les surintensités de courants forts KMH

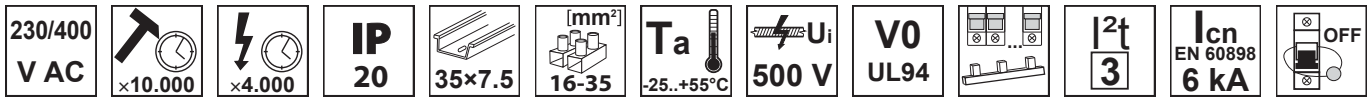

TRACON		I_n (A)
	KMH-163	63
	KMH-180	80
	KMH-1100	100
	KMH-1125	125

TRACON		I_n (A)
	KMH-363	63
	KMH-380	80
	KMH-3100	100
	KMH-3125	125

TRACON		I_n (A)
	KMH-263	63
	KMH-280	80
	KMH-2100	100
	KMH-2125	125

TRACON		I_n (A)
	KMH-463	63
	KMH-480	80
	KMH-4100	100
	KMH-4125	125

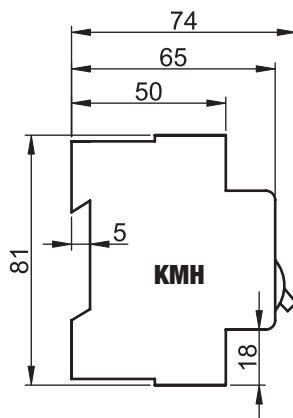
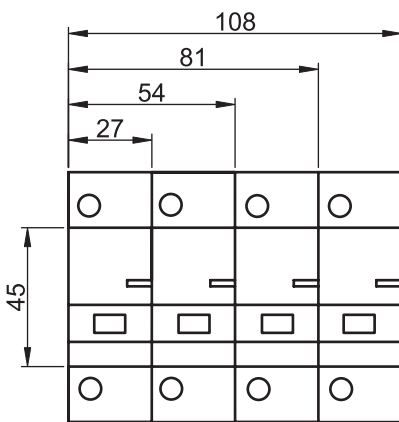
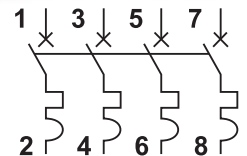
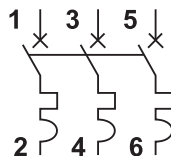
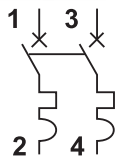

Caractéristiques de déclenchement

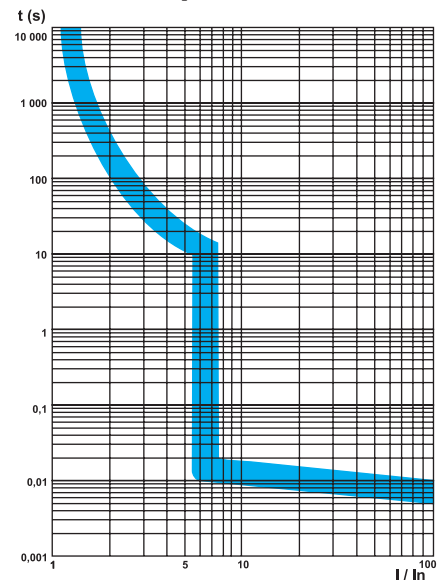

RELEVANT STANDARD
EN 60898

Disjoncteurs à courant résiduel (un module de large)

230 V AC
 $\times 20.000$
 $\times 4.000$
IP 20
35x7.5
[mm²] 1-16
Ta -25..+55°C
690 V U_i
V0 UL94
AC
I_{cn} EN 60898 6 kA
OFF

TRACON		I _n (A)	I Δ _n (mA)
B	C		
KVKVEB-6/30	KVKVE-6/30	6	30
KVKVEB-6/100	KVKVE-6/100	6	100
KVKVEB-10/30	KVKVE-10/30	10	30
KVKVEB-10/100	KVKVE-10/100	10	100
KVKVEB-13/30	KVKVE-13/30	13	30
KVKVEB-13/100	KVKVE-13/100	13	100
KVKVEB-16/30	KVKVE-16/30	16	30
KVKVEB-16/100	KVKVE-16/100	16	100
KVKVEB-20/30	KVKVE-20/30	20	30
KVKVEB-20/100	KVKVE-20/100	20	100
KVKVEB-25/30	KVKVE-25/30	25	30
KVKVEB-25/100	KVKVE-25/100	25	100
KVKVEB-32/30	KVKVE-32/30	32	30
KVKVEB-32/100	KVKVE-32/100	32	100

⊗ ⊗
 2P
⊗ ⊗

Caractéristique de déclenchement

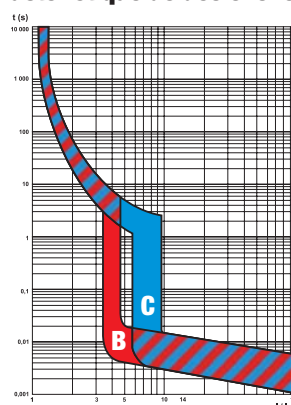

E3

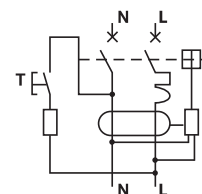
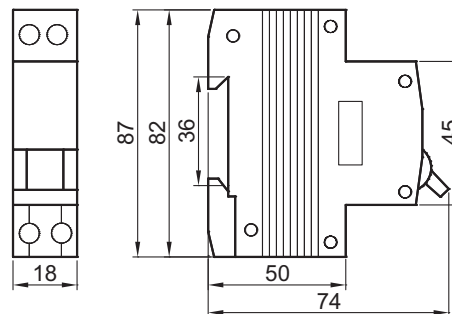

Pictogrammes F/O

RELEVANT STANDARD EN 61009-1

Disjoncteurs à courant résiduel KVK

230 V AC
 $\times 20.000$
 $\times 4.000$
IP 20
35x7.5
[mm²] 1,0-10
Ta -25..+55°C
690 V U_i
V0 UL94
AC
I_{cn} EN 60898 3 kA
OFF

TRACON		I _n (A)	I Δ _n (mA)
B	C		
KVKB-6/03	KVK-6/03	6	30
KVKB-6/10	KVK-6/10	6	100
KVKB-6/30	KVK-6/30	6	300
KVKB-10/03	KVK-10/03	10	30
KVKB-10/10	KVK-10/10	10	100
KVKB-10/30	KVK-10/30	10	300
KVKB-16/03	KVK-16/03	16	30
KVKB-16/10	KVK-16/10	16	100
KVKB-16/30	KVK-16/30	16	300
KVKB-20/03	KVK-20/03	20	30
KVKB-20/10	KVK-20/10	20	100
KVKB-20/30	KVK-20/30	20	300
KVKB-25/03	KVK-25/03	25	30
KVKB-25/10	KVK-25/10	25	100
KVKB-25/30	KVK-25/30	25	300
KVKB-32/03	KVK-32/03	32	30
KVKB-32/10	KVK-32/10	32	100
KVKB-32/30	KVK-32/30	32	300

⊗ ⊗
 2P
⊗ ⊗

Caractéristique de déclenchement

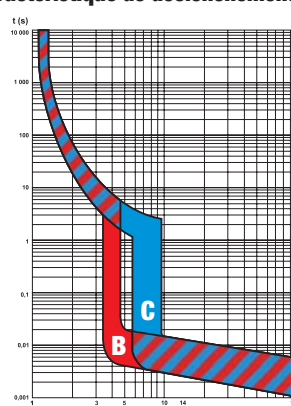

E3

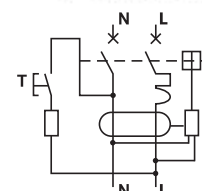
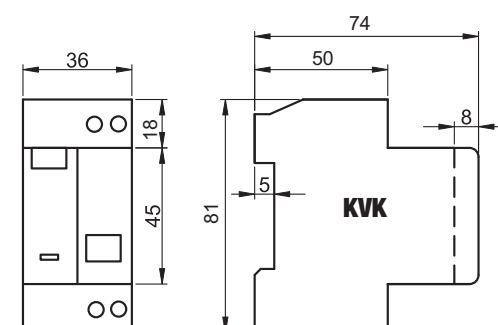

Disjoncteurs à courant résiduel KVKM

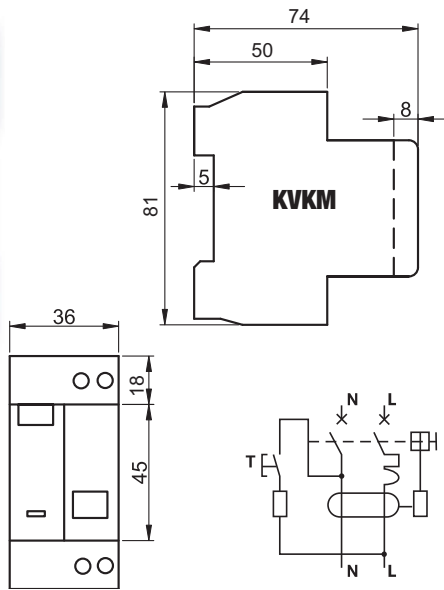
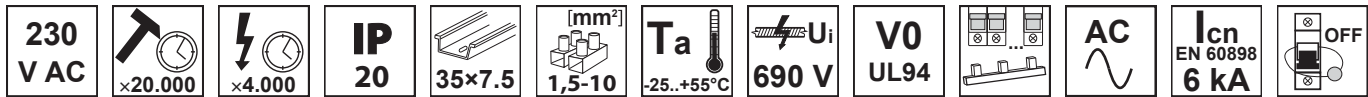

TRACON		I _n (A)	I Δ _n (mA)
B	C		
KVKMB-6/030	KVKM-6/030	6	30
KVKMB-6/100	KVKM-6/100	6	100
KVKMB-6/300	KVKM-6/300	6	300
KVKMB-10/030	KVKM-10/030	10	30
KVKMB-10/100	KVKM-10/100	10	100
KVKMB-10/300	KVKM-10/300	10	300
KVKMB-16/030	KVKM-16/030	16	30
KVKMB-16/100	KVKM-16/100	16	100
KVKMB-16/300	KVKM-16/300	16	300
KVKMB-20/030	KVKM-20/030	20	30
KVKMB-20/100	KVKM-20/100	20	100
KVKMB-20/300	KVKM-20/300	20	300
KVKMB-25/030	KVKM-25/030	25	30
KVKMB-25/100	KVKM-25/100	25	100
KVKMB-25/300	KVKM-25/300	25	300
KVKMB-32/030	KVKM-32/030	32	30
KVKMB-32/100	KVKM-32/100	32	100
KVKMB-32/300	KVKM-32/300	32	300
KVKMB-40/030	KVKM-40/030	40	30
KVKMB-40/100	KVKM-40/100	40	100
KVKMB-40/300	KVKM-40/300	40	300



Le disjoncteur à courant résiduel protège des chocs électriques même en cas de rupture du conducteur neutre!

Interrupteurs automatiques à courant différentiel résiduel RB

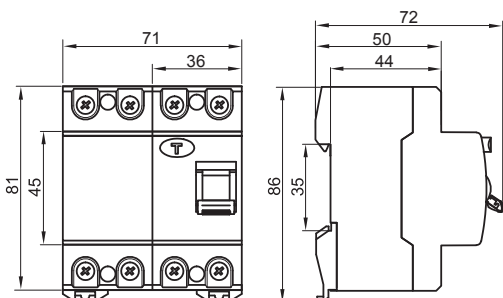
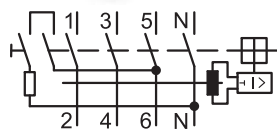
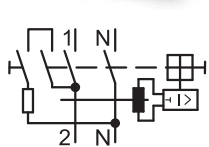
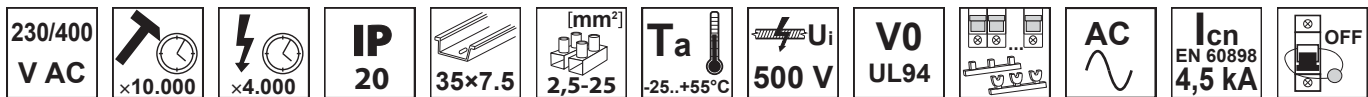

TRACON	I _n (A)	I Δ _n (mA)
RB2-25030	25	30
RB2-25100	25	100
RB2-25300	25	300
RB2-25500	25	500
RB2-40030	40	30
RB2-40100	40	100
RB2-40300	40	300
RB2-40500	40	500
RB4-25030	25	30
RB4-25100	25	100
RB4-25300	25	300
RB4-25500	25	500
RB4-40030	40	30
RB4-40100	40	100
RB4-40300	40	300
RB4-40500	40	500
RB4-63030	63	30
RB4-63100	63	100
RB4-63300	63	300
RB4-63500	63	500

Interrupteurs automatiques à courant différentiel résiduel TFV

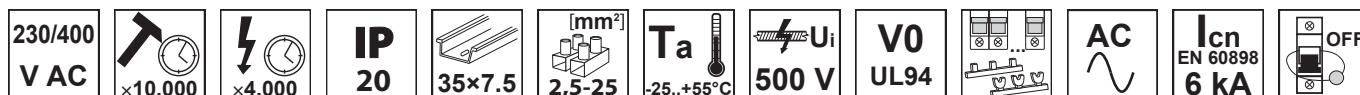

TRACON	I_n (A)	$I_{\Delta n}$ (mA)
TFV2-16030	16	30
TFV2-16100	16	100
TFV2-16300	16	300
TFV2-25030	25	30
TFV2-25100	25	100
TFV2-25300	25	300
TFV2-40030	40	30
TFV2-40100	40	100
TFV2-40300	40	300
TFV2-63030	63	30
TFV2-63100	63	100
TFV2-63300	63	300
TFV4-16030	16	30
TFV4-16100	16	100
TFV4-16300	16	300
TFV4-25030	25	30
TFV4-25100	25	100
TFV4-25300	25	300
TFV4-40030	40	30
TFV4-40100	40	100
TFV4-40300	40	300
TFV4-63030	63	30
TFV4-63100	63	100
TFV4-63300	63	300

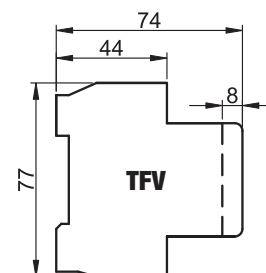
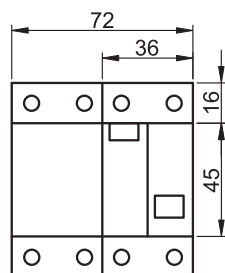
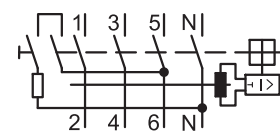
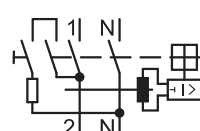
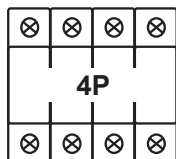
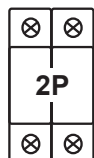

Interrupteurs de puissance à courant résiduel TFVH

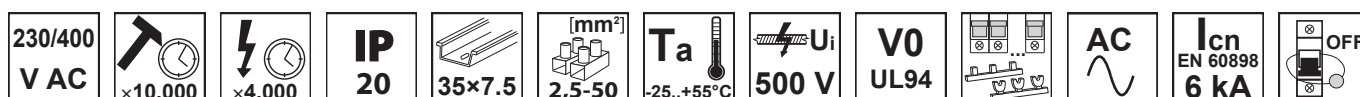

TRACON	I_n (A)	$I_{\Delta n}$ (mA)
TFVH4-80030	80	30
TFVH4-80100	80	100
TFVH4-80300	80	300
TFVH4-100030	100	30
TFVH4-100100	100	100
TFVH4-100300	100	300
TFVH4-125030	125	30
TFVH4-125100	125	100
TFVH4-125300	125	300

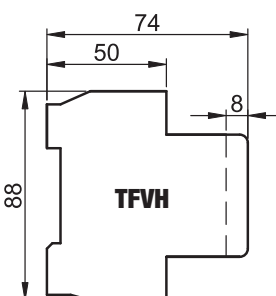
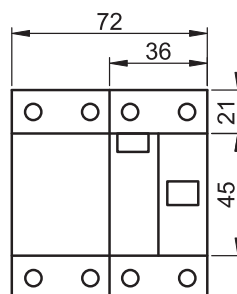
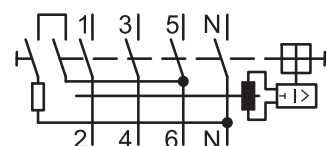
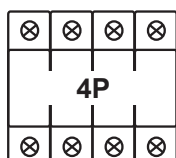

TÜV MEEI TEST DOCUMENTATION
M1 2792130 01

Interrupteurs automatiques à courant différentiel résiduel TFG

230/400 V AC			IP 20	35x7.5	[mm²] 2,5-25	Ta -25..+55°C	500 V	V0 UL94		A, AC	I_{cn} EN 60898 6 kA	
-----------------	--	--	-----------------	--------	-----------------	-------------------------	--------------	-------------------	--	--------------	--	--

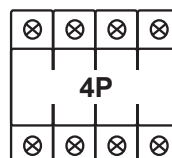
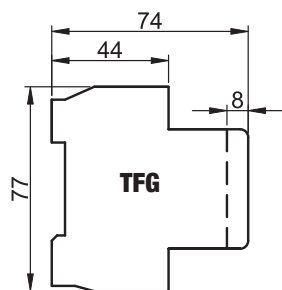
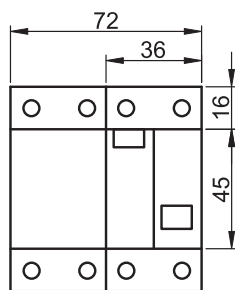
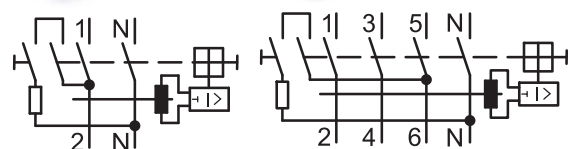

TRACON	I _n (A)	I _{Δn} (mA)
TFG2-16030	16	30
TFG2-16100	16	100
TFG2-16300	16	300
TFG2-25030	25	30
TFG2-25100	25	100
TFG2-25300	25	300
TFG2-40030	40	30
TFG2-40100	40	100
TFG2-40300	40	300
TFG2-63030	63	30
TFG2-63100	63	100
TFG2-63300	63	300
TFG4-16030	16	30
TFG4-16100	16	100
TFG4-16300	16	300
TFG4-25030	25	30
TFG4-25100	25	100
TFG4-25300	25	300
TFG4-40030	40	30
TFG4-40100	40	100
TFG4-40300	40	300
TFG4-63030	63	30
TFG4-63100	63	100
TFG4-63300	63	300



RELEVANT STANDARD
EN 61008-1

Adaptateur pour interrupteurs automatiques à courant différentiel résiduel TFGA

TRACON		I _n (A)	I _{Δn} (mA)	P _{max}	IP..
TFGA-1		16	30	3.600 W	IP 40
TFGA-1F		16	30	3.600 W	IP 40
TFGA-4F		16	30	3.600 W	IP 44



230 V AC	Ta -25..+55°C	500 V	
	V0 UL94		
I_{cn} EN 60898 6 kA			

L'adaptateur TFGA, pour interrupteurs à courant différentiel résiduel dans les circuits PE, représente le moyen le plus moderne de protection contre les contacts indirects, voire dans certains cas, directs également.

L'interrupteur est activé automatiquement lorsque dans le réseau à protéger la valeur du courant résiduel atteint la valeur critique. Étant portable, il peut être utilisé dans tout réseau non pourvu d'une protection par interrupteur à courant résiduel.

L'appareil est activé en appuyant sur le bouton RESET. Avant la première utilisation, l'appareil doit être testé grâce au bouton TEST, ce qui a pour effet d'isoler la prise du réseau. En cas d'utilisation permanente, l'appareil doit être vérifié au moins une fois par mois au moyen du bouton TEST. Une fois l'adaptateur branché, le réseau (appareils) à protéger doit être connecté à la prise de l'appareil.

TÜV MEEI TEST DOCUMENTATION
M1 2792130 01

ETL-SEMCO CERTIFICATE NO.
630406

Interrupteur à courant résiduel avec commande motorisée automatique de reletage

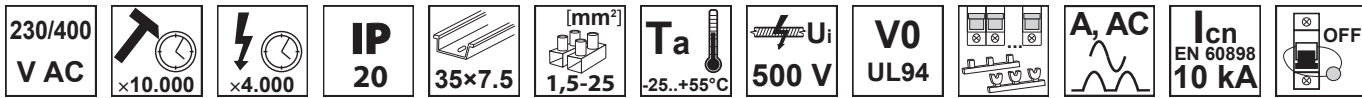

TRACON				I _n (A)
	IΔn= 30 mA	IΔn= 100 mA	IΔn= 300 mA	
	TFIG2-16030	TFIG2-16100	TFIG2-16300	16
	TFIG2-25030	TFIG2-25100	TFIG2-25300	25
	TFIG2-40030*	TFIG2-40100*	TFIG2-40300	40
	TFIG2-63030	TFIG2-63100	TFIG2-63300	63
	TFIG4-16030	TFIG4-16100	TFIG4-16300	16
	TFIG4-25030	TFIG4-25100	TFIG4-25300	25
	TFIG4-40030	TFIG4-40100*	TFIG4-40300	40
	TFIG4-63030	TFIG4-63100	TFIG4-63300*	63
	TFIG4-80030	TFIG4-80100	TFIG4-80300	80



* en stock, autres versions disponibles sur demande avec un délai de livraison de 4 semaines

L'appareil sert au reletage des dispositifs déclenchés par un éventuel courant de fuite important ou par une surintensité due à un phénomène atmosphérique après la baisse à un niveau donné des courants de fuite sinusoïdaux ou continus pulsés.

De tels dispositifs sont un avantage dans le cas d'équipements fonctionnant sans personnel de surveillance permanent où le déclenchement des appareils de protection provoque des arrêts de longue durée en raison de l'arrivée tardive des équipes techniques (stations de télécommunication, contrôle des lampes de signalisation, dispositifs de commutation à commande à distance).

La cause de la surintensité est généralement transitoire, rendant l'arrêt injustifié et provoquant des dommages importants.

Les dispositifs de reletage sont faciles d'installation et de configuration. Il suffit de tirer latéralement l'interrupteur coulissant situé en façade vers la position automatique.

Si l'appareil ne parvient pas à réactiver l'interrupteur à courant résiduel après un nombre pré-réglé de tentatives (1 à 8), l'état d'arrêt sera maintenu. Une fois que le défaut a été éliminé, l'interrupteur peut être réactivé manuellement. Pour l'entretien, avant d'éteindre le disjoncteur, le technicien doit remettre l'interrupteur coulissant situé en façade en position OFF (arrêt), autrement l'interrupteur à courant résiduel va se réactiver automatiquement! Afin de prévenir toute reconnexion intempestive, une version verrouillable est également disponible sur demande spéciale.

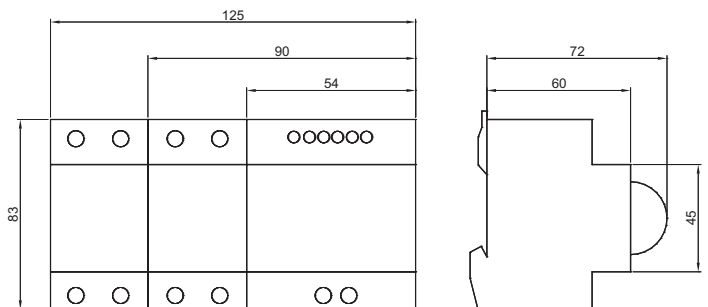
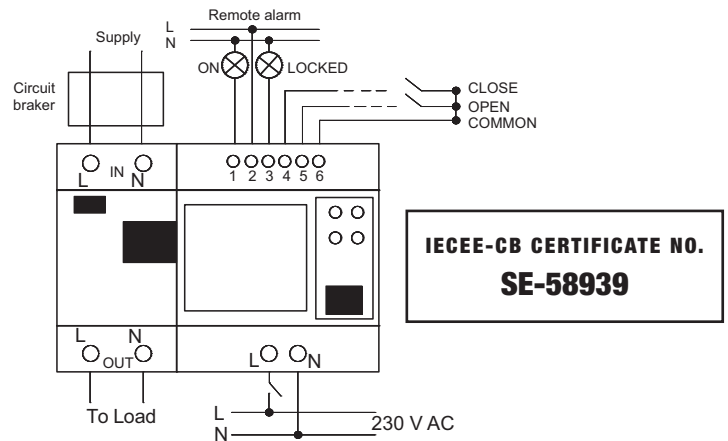

Caractéristiques techniques	Interrupteur à courant résiduel	Dispositif de reletage motorisé
Nombre réglable de reletage	–	1, 2, 4, 6, 8
Temps de rupture /Temps de déconnexion	0,1 s	1 s
Temps de connexion	–	2 s
Délai de temporisation du reletage	–	10 – 30 – 60 – 120 – 180 s
Indicateur de fonctionnement LED	–	vert: ON (en service), rouge: OFF (verrouillé), Rouge clignotant: attente de reletage
Commutation marche/arrêt manuelle	par levier	par curseur
Charge du contact auxiliaire	–	250 V AC, 5 A
Entrée commande à distance	–	NC / NO / CO

Contacteurs d'installation

230/400 V AC	x1.000.000	x30.000	IP 20	35x7.5	[mm ²] 1,5-25	Ta -25...+55°C	U_i 500 V	V0 UL94	ON-OFF-ON... sc/h x360	Pictogrammes F/0
-----------------	------------	---------	--------------	--------	------------------------------	--------------------------	-------------------------------	-------------------	------------------------------	-------------------------

TRACON	U _m	I _n (A)	I _e			NC NO
			AC1/AC7a	AC3 (400V)	AC7b	
THK2-20-24	24 V AC	20 A	20	-	7	2 NO
THK2-20-24/1NO+1NC/	24 V AC	20 A	20	-	7	1NO+1NC
THK2-20	230 V AC	20 A	20	-	7	2 NO
THK2-20/1NO+1NC/	230 V AC	20 A	20	-	7	1NO+1NC
THK2-32-24	24 V AC	32 A	32	-	12	2 NO
THK2-32	230 V AC	32 A	32	-	12	2 NO
THK2-40-24	24 V AC	40 A	40	-	15	2 NO
THK2-40	230 V AC	40 A	40	-	15	2 NO
THK3-20-24	24 V AC	20 A	20	5	7	3 NO
THK3-20	230 V AC	20 A	20	5	7	3 NO
THK3-32-24	24 V AC	32 A	32	5.5	12	3 NO
THK3-32	230 V AC	32 A	32	5.5	12	3 NO
THK3-40-24	24 V AC	40 A	40	7	15	3 NO
THK3-40	230 V AC	40 A	40	7	15	3 NO
THK4-20-24	24 V AC	20 A	20	5	7	4 NO
THK4-20	230 V AC	20 A	20	5	7	4 NO
THK4-32-24	24 V AC	32 A	32	5.5	12	4 NO
THK4-32	230 V AC	32 A	32	5.5	12	4 NO
THK4-40-24	24 V AC	40 A	40	7	15	4 NO
THK4-40	230 V AC	40 A	40	7	15	4 NO
THK4-63	230 V AC	63 A	63	15	20	4 NO
THK4-63-24	24 V AC	63 A	63	15	20	4 NO
THK4-63/2NO+2NC/	230 V AC	63 A	63	15	20	2NO+2NC
THK4-63-24/2NO+2NC/	24 V AC	63 A	63	15	20	2NO+2NC

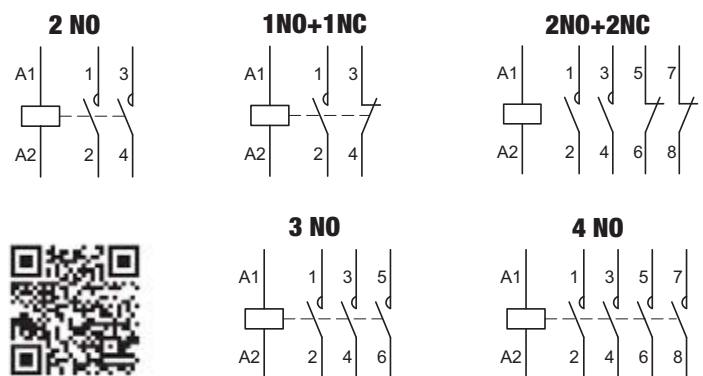

THK2-20

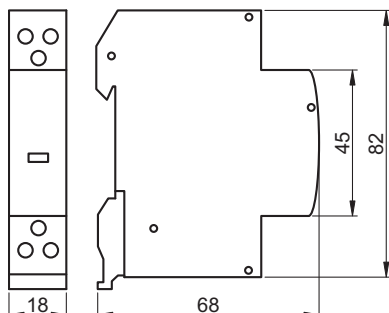

THK2-32, 2-40, 3-20, 4-20

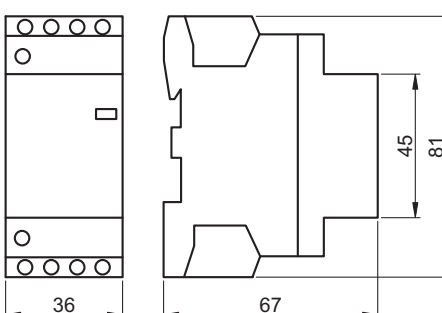

THK3-32, 3-40, 4-32, 4-40, 4-63

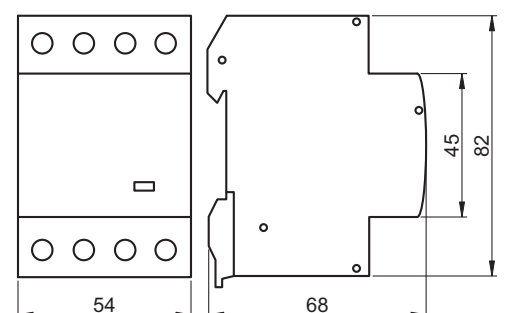

Minuterie d'escalier

230 V AC	1-2,5 [mm ²]	IP 20	Ta -20..+55°C	35x7.5	1xCO →AUX	x40.000	500 V U _i	V0 UL94	Pictogrammes F/O
-----------------	---------------------------------	--------------	----------------------	---------------	------------------	----------------	-----------------------------	----------------	-------------------------

TRACON		P _s	I _n	L	Σ	P _{max}	
TLA-3	30 sec – 12 min	1 VA	16 A (cos φ = 1)	max. 250 m	max. × 50	max. 2.300 W	max. 800 W
NARS	30 sec – 20 min	1.5 VA	16 A (cos φ = 1)	max. 250 m	max. × 50	max. 2.000 W	max. 400 W

Application :
Peut être utilisé pour une minuterie dans des escaliers

RELEVANT STANDARD EN 60730

RELEVANT STANDARD EN 60669-2

Connexion 3 câbles

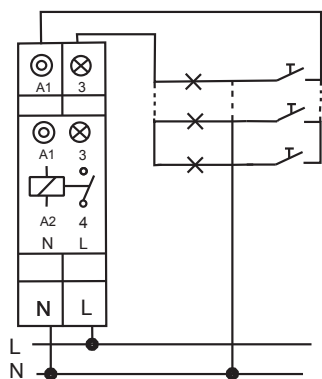

Connexion 4 câbles

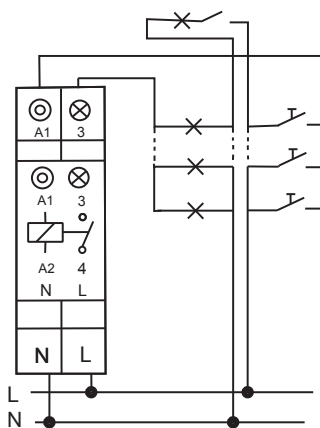

Connexion 3 câbles

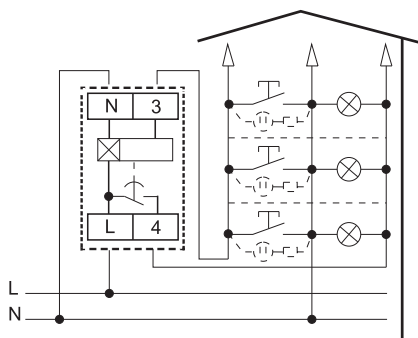

Connexion 4 câbles

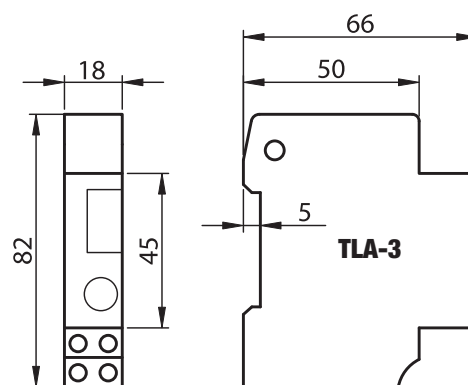
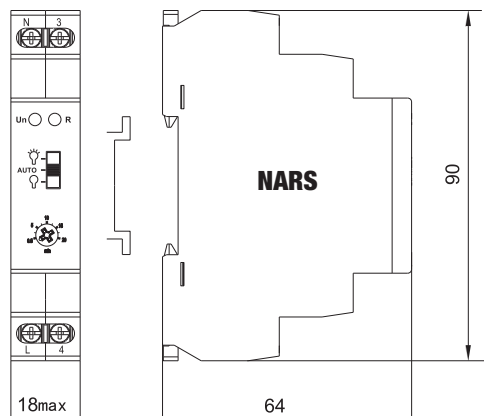
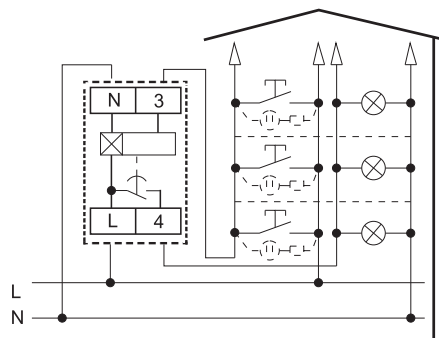

Relais d'impulsion

$\times 10^5$
 $\times 10^5$
 P_m 0,02 VA
 IP 20
 [mm²] 0,75-4
 35x7.5
 T_a $-25..+55^{\circ}\text{C}$
 U_i 500 V



TRACON	U _m	P _{max}		$\cos\phi=1$	$\cos\phi=0,6$
IMP-12	12 V AC	max. 3.500 W	max. 1.300 W	$\times 100.000$	$\times 50.000$
IMP-24	24 V AC	max. 3.500 W	max. 1.300 W	$\times 100.000$	$\times 50.000$
IMP-230	230 V AC	max. 3.500 W	max. 1.300 W	$\times 100.000$	$\times 50.000$
NARIMP	AC/DC12V-240V	max. 2.000 W	max. 900 W	500.000	250.000



IMP-..

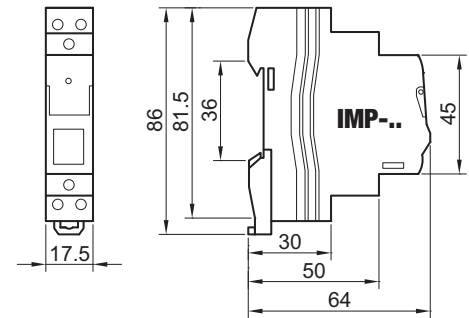
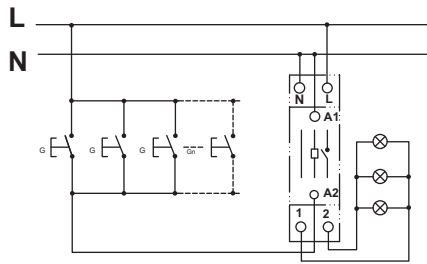

Application :

Ces relais modulaires à impulsion sont bistables et permettent de contrôler les circuits électriques. Ils peuvent être déclenchés manuellement. La phase et le neutre doivent traverser le relais mais seule la phase sera déclenchée.



NARIMP

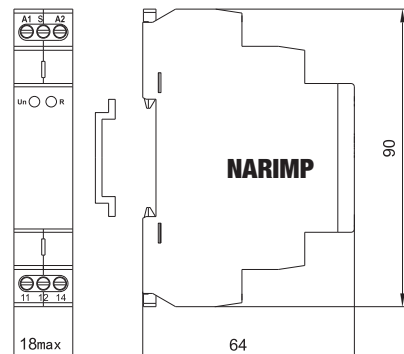
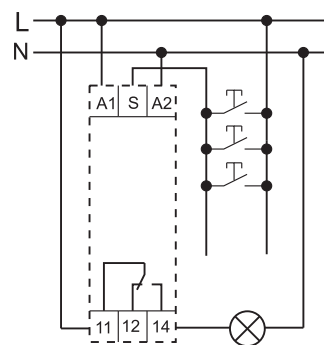

Sonnettes

P_m 0,05 VA
 50/60 Hz





 IP 20
 [mm²] 1,0-10
 35x7.5
 T_a $-25..+55^{\circ}\text{C}$
 U_i 500 V

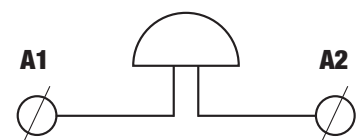
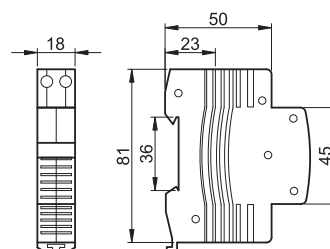

TRACON	U _m		
C60-CSEN	230 V AC	60 dB	max. 60 min.
C60-CSEN-24	24 V AC	60 dB	max. 60 min.
C60-CSEN-12	12 V AC	60 dB	max. 60 min.
C60-CSEN-8	8 V AC	60 dB	max. 60 min.



Transformateur de sécurité (sonnette)

IP 20	 35x7.5	 [mm ²] 0,75-2,5	T_a -25..+55°C	 U _i 500 V	V0 UL94	
-----------------	--	--	------------------------------------	---	-------------------	---

 Pictogrammes **F/0**

TRACON	P _s	U _{pr}	U _{sec}	I _{sec}
BT-8/1	max. 8 VA	230 V AC	4, 8, 12 V AC	0,66 A
BT-8/2			8, 12, 24 V AC	0,33 A

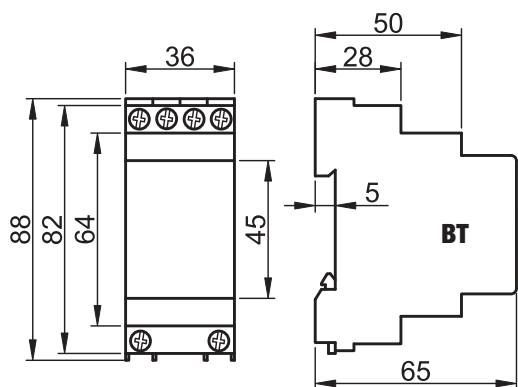

Transformateur sécurisé de séparation fournissant une très basse tension. Utilisés généralement pour électrique de sonnettes, ils peuvent, selon la puissance, être utilisés à d'autres fins également telles que l'alimentation en courant alternatif des appareils électroniques.



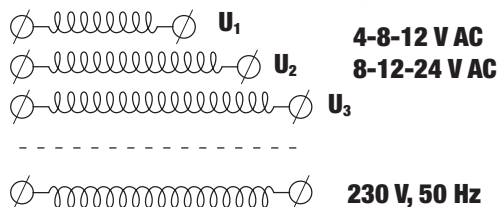

RELEVANT STANDARD
EN 61558-2-8



Prises modulaires

IP 20	 35x7.5	 [mm ²] 0,75-2,5	T_a -25..+55°C	 U _i 500 V	V0 UL94
-----------------	--	--	------------------------------------	---	-------------------

TRACON		I _n (A)	U _n
C60-DA0	2P+ ⊥ 	16	250 V AC
C60-DA	2P+ ⊥ 	16	250 V AC

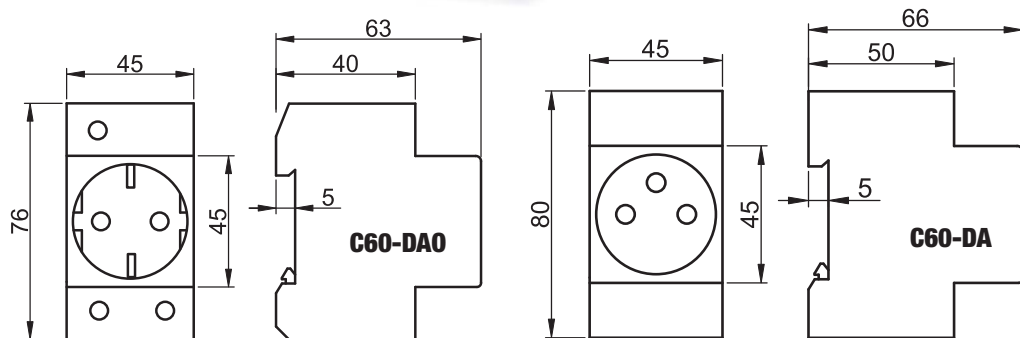

RELEVANT STANDARD
MSZ 9872

































RELEVANT STANDARD
IEC 60884-1

TÜV MEEI TEST DOCUMENTATION
28208191 001

230 V AC	V1 UL94	IP 54	[mm²] 1-2,5	Ta -25...+55°C	U_i 500 V
--------------------	-------------------	-----------------	----------------------------------	--------------------------	-------------------------------

 **Pictogrammes F/0**



TRACON		 SHUKO	 FRENCH	
TR-PH01		×1	-	-
TR-PHF01		-	×1	-
TR-PH02	 	×2	-	-
TR-PHF02	 	-	×2	-
TR-PH03		×1	-	101
TR-PHF03	 	-	×1	101
TR-PH08		×1	-	106
TR-PHF08		-	×1	106
TR-PH03V		×1	-	101
TR-PHF03V		-	×1	101
TR-PH08V		×1	-	106
TR-PHF08V		-	×1	106
TR-PH09V		×1	-	2×101
TR-PHF09V		-	×1	2×101
TR-PH10V		×1	-	2×106
TR-PHF10V		-	×1	2×106
TR-PH09		×1	-	2×101
TR-PHF09		-	×1	2×101
TR-PH10		×1	-	2×101
TR-PHF10		-	×1	2×101
TR-PH04		-	-	102
TR-PH05		-	-	101
TR-PH05L*		-	-	101
TR-PH06		-	-	106
TR-PH06L*		-	-	106
TR-PH07		-	-	N101
TR-PH07L*		-	-	N101
TR-PH05-2		-	-	2×101
TR-PH06-2		-	-	2×106

* voyant lumineux

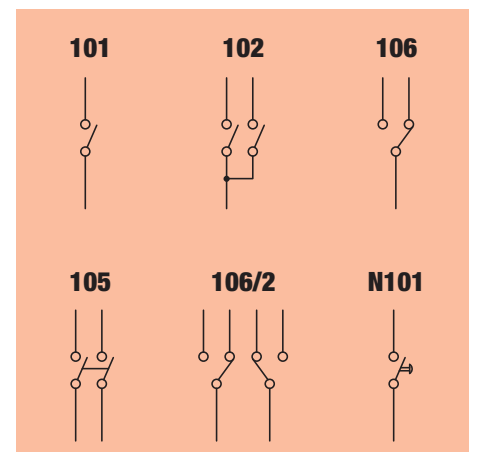
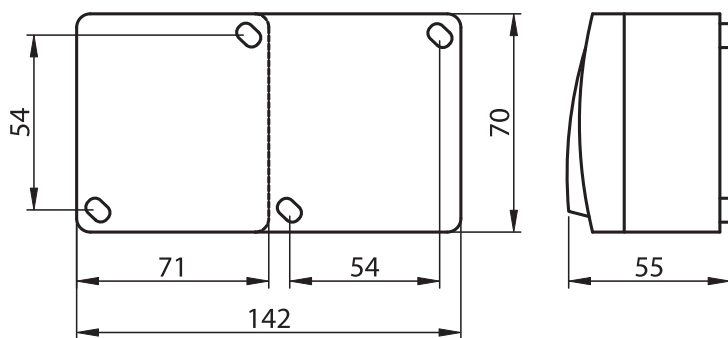

RELEVANT STANDARD
EN 60669-1







TÜV MEEI TEST DOCUMENTATION
28208176 001

Gamme d'interrupteurs en saillie TTK









230 V AC	V1 UL94	IP 20	[mm ²] 1-2,5	Ta -25..+55°C	U _i 500 V
-------------	------------	----------	-----------------------------	------------------	-------------------------

 Pictogrammes **F/0**





TRACON

TTK-11	TTK-12	TTK-13*	TTK-21	TTK-31	TTK-32
					
SCHUKO	FRENCH	NO EARTH*	(RJ11 6/4) Telephone	9,5 mm TV	9,5 mm TV+FM

TRACON

TTK-01	TTK-02	TTK-03	TTK-04B	TTK-04L	TTK-04W	TTK-05	TTK-06	TTK-07
								
101	106	102	N101	N101	N101	2x101	105	2xN101

* À utiliser uniquement en pièces de remplacement dans d'anciennes installations.

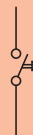
101 	102 	105 	106 	N101 
---	---	---	---	--

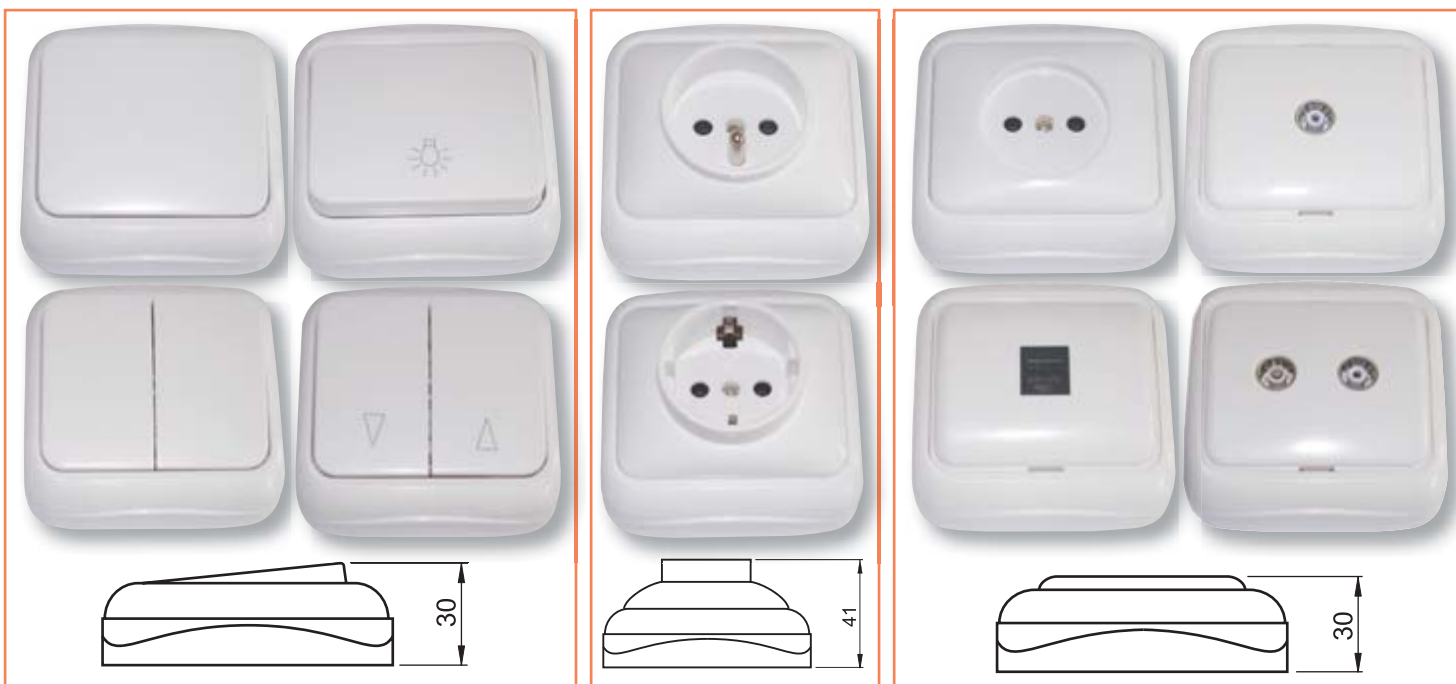
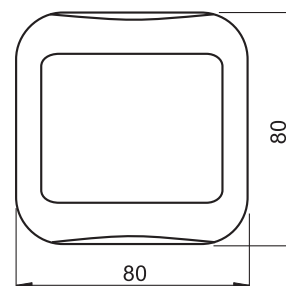

RELEVANT STANDARD
EN 60669-1

RELEVANT STANDARD
IEC 60884-1

RELEVANT STANDARD
MSZ 9871-2







TÜV MEEI TEST DOCUMENTATION
28208176 001

Gamme d'interrupteurs en saillie TFK

230 V AC	V1 UL94	IP 20	[mm ²] 1-2,5	Ta -25..+55°C	U _i 500 V	50/60 Hz
-------------	------------	----------	-----------------------------	------------------	-------------------------	----------

 Pictogrammes **F/O**

TRACON

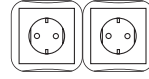
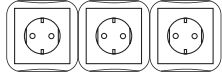
TFK101	TFK101B	TFK102	TFK105	TFK106	TFKSCH	TFKSCH-2	TFKSCH-3
							
× 1 10 AX/250 V IP 20, (101)	× 1 10 AX/250 V IP 20, (N101)	× 1 10 AX/250 V IP 20, (102)	× 1 10 AX/250 V IP 20, (2×101)	× 1 10 AX/250 V IP 20, (106)	× 1 16 A/250 V, IP 20	× 2 16 A/250 V, IP 20	× 3 16 A/250 V, IP 20

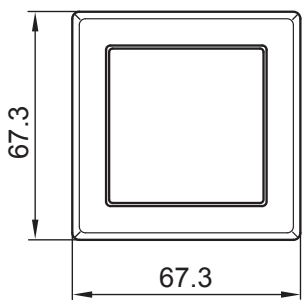

TFK...

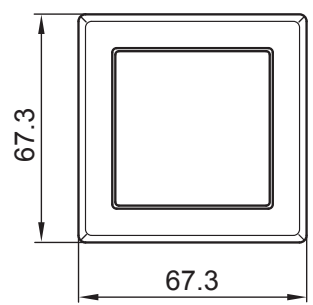

TFKSCH..

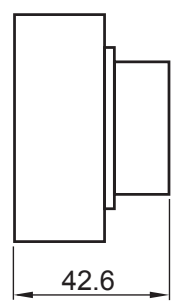

TFK101B



TFK102



TFK105



TFKSCH

**FAMILLE
D'INTERRUPTEURS
INTELLIGENTS**



Consultez notre boutique en ligne pour découvrir nos nouveautés.

Prise Shuko avec port USB

230 V AC	V1 UL94	IP 20	$[mm^2]$ 1-2,5	Ta -25..+55°C	U_i 500 V	50/60 Hz
--------------------	-------------------	-----------------	-------------------	-------------------------	----------------	----------

 Pictogrammes **F/O**

TRACON

USB-21



× 1
16 A/250 V,
IP 20

USB:5V, 2100mA





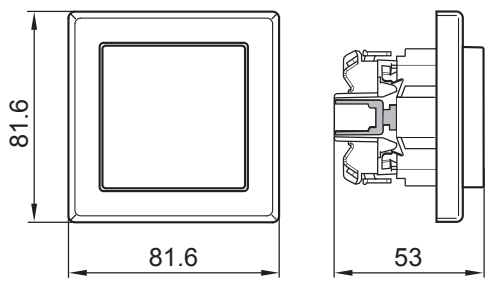



SCHUKO + USB



Transformateur de sécurité (sonnette)

U_i 500 V	50/60 Hz	$[mm^2]$ 0,75-2,5	Ta -25..+55°C		IP 20
----------------	----------	----------------------	-------------------------	---	-----------------

 Pictogrammes **F/O**

TRACON	U_m	I_n		 [h]	H (mm)	W (mm)	D_1 (mm)	D_2 (mm)	d (mm)
BELL8S 	8 V AC	0,33 A	65 dB	max. 60 min.	148	72	36	36	76
BELL8 	8 V AC	0,55 A	85 dB	max. 60 min.	220	124	47	61	120
BELL24 	24 V AC	0,17 A	85 dB	max. 60 min.	220	124	47	61	120
BELL230 	230 V AC	0,03 A	85 dB	max. 60 min.	220	124	47	61	120

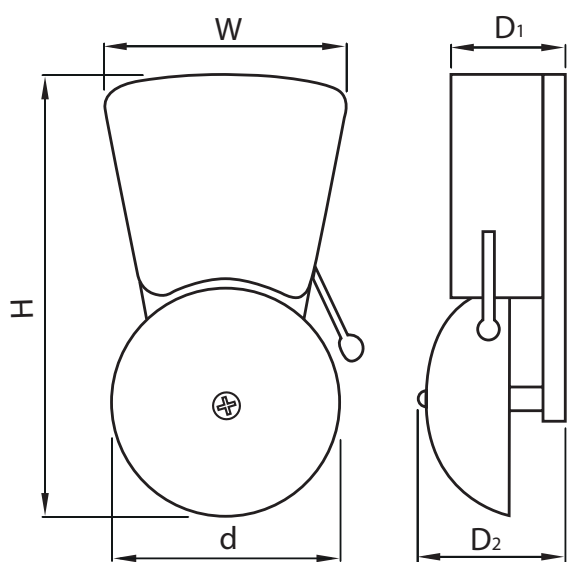

BELL8, BELL24, BELL230 **BELL8S**

Détecteur de monoxyde de carbone

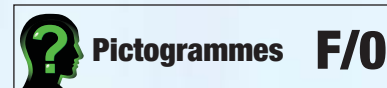
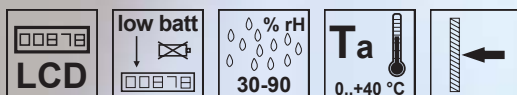

Concentration en gas CO	30 ppm	50 ppm	100 ppm	300 ppm
Exigence de la norme EN 50291	Pas d'alarme	60 - 90 min.	10 - 40 min.	<3 min.
Valeurs mesurées lors du contrôle No R-546875 réalisé par TÜV-SÜD	Pas d'alarme	66 - 71 min.	26 - 33 min.	64 - 85 s
Valeurs mesurées lors du contrôle No G/265/2015 réalisé par Szenczortchnika Ltd.	Pas d'alarme	71 - 72 min.	20 min.	31 - 50 s

Ce détecteur compact permet de déceler la présence de monoxyde de carbone (CO), gas totalement incolore et inodore, dans l'air. Le monoxyde de carbone peut résulter d'une combustion incomplète sur des chauffages défectueux, pouvant provoquer la mort par asphyxie. L'appareil dispose de 4 niveaux d'alarmes visuelles et sonores se déclenchant selon des valeurs de concentration pré-établies, protégeant ainsi les occupants du logement. Cependant, l'appareil ne protège pas contre les effets chroniques du gas et ne permet pas une protection complète à lui seul contre des risques spéciaux. L'utilisation du capteur ne remplace pas une maintenance et un entretien adéquat des chauffages et des ventilations.

Élément de détection: cellule électrochimique
 Alimentation électrique: 3 piles AA de 1,5 V
 Consommation de courant: au repos: < 80 µA
 en alarme: 0,4 - 1,5 mA
 Type d'alarme: alarme lumineuse et sonore
 Affichage (LCD): état de base: PPM, température ambiante, état des piles
 alarme/test: ERR – erreur; --- - test; HCO – valeur de CO élevée
 Indicateur visuel (LED): fonctionnement (vert), défaut (jaune), alarme (rouge)
 Temps de réponse: 5 s
 Bouton de test intégré

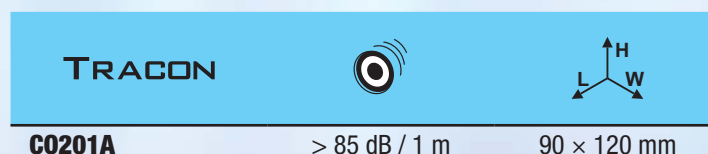

C0201A

> 85 dB / 1 m

90 × 120 mm



La durée de vie du détecteur est de 7 ans après la date d'installation. Un avertissement apparaîtra à l'écran lorsque la durée de vie sera dépassée.



TRACON
ELECTRIC®



Prévenir les accidents

Détecteur de fumée sans fil interconnectable

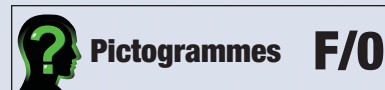
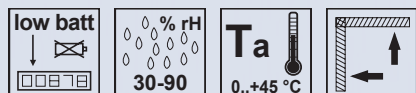

SD101LD > 85 dB / 3 m 433,92 MHz Ø125 x 125 x 48 mm

Le détecteur de fumée sans fil révèle la présence de fumée dans l'air et représente une protection idéale contre les incendies. Le capteur émet un signal sonore en cas de fumée et ce signal peut être envoyé à d'autres appareils similaires. La présence de fumée à l'intérieur d'un bâtiment peut ainsi être signalée à l'extérieur de celui-ci

Alimentation électrique : 3 piles AA de 1,5 V (émetteur)
1 pile 9 V 6LR61 (détecteur)
Type d'alarme : alarme lumineuse et sonore
Consommation de courant : Au repos (9 V) : < 12 µA
Alarme (9V) : < 20 mA
Signal (4,5 V) : < 230 µA

Bouton de test et d'apprentissage

RELEVANT STANDARD
EN 14604:2005



Détecteur de fumée non connectable

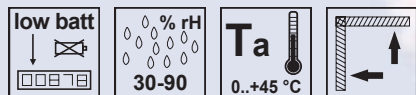

SD133A > 85 dB / 3 m 103x103x35 mm

Le mode opératoire de ce détecteur est identique à celui des détecteurs interconnectables mais il ne dispose pas de module de communication envoyant le signal sur d'autres appareils.

Alimentation électrique : 1 pile 9 V 6LR61 (détecteur)
Type d'alarme : alarme lumineuse et sonore
Consommation de courant : Au repos (9 V) : < 12 µA
Alarme (9V) : < 20 mA
Signal (4,5 V) : < 230 µA

Bouton de test et d'apprentissage



RELEVANT STANDARD
EN 14604:2005



**CONSULTEZ LES FICHES TECHNIQUES DE NOS PRODUITS
SUR NOTRE WEBSHOP POUR PLUS D'INFORMATION.**