

Pictogramele capului de tabel

 Note, completări	 Putere nominală	 Tipul soclului	 Fluxul luminos (lumen)
 Temperatura de culoare (Kelvin)	 Înlocuire lămpi fluorescente compacte	 Numărul de LED-uri (buc)	 Clasa de eficiență energetică
 Înlocuire bec incandescent clasic	 Curent nominal (A)	 Înlocuire halogenuri metalice	 Înlocuire surse halogen
 Înlocuire tuburi fluorescente	 Timp de întârziere	 Înălțimea și diametrul stâlpului (mm)	 Grad de protecție
 Autonomie (h)	 Numărul de cleme pentru prinderea dispersorului (buc)	 Durata de viață	 Randament
 Iluminarea (lux)	 Capacitatea electrică	 Culoarea dispersorului	 Ambalare
 Dimensiunea decupării (mm)	 Contact de protecție lateral	 Unghi flux luminos (°)	 Dimensiuni (LxWxH)
 Înclinare corp de iluminat (°)	 Capacitatea acumulatorului (Ah)	 Contact de protecție tip pin	 Culoare
 Curent primar	 Curent maxim în înfășurarea secundară	 Tensiunea acumulatorului (V)	 Tipul acumulatorului
 Tensiune nominală (V)			

Pictogramele datelor tehnice

 Tensiune nominală (V)	 Corp de iluminat în clasa I de protecție la atingere	 Corp de iluminat în clasa II de protecție la atingere	 Corp de iluminat în clasa III de protecție la atingere
 Corpul de iluminat se poate monta pe tavan	 Corp de iluminat potrivit pentru iluminat interior	 Corp de iluminat potrivit pentru iluminat interior și exterior	 Corp de iluminat potrivit pentru iluminat exterior
 Frecvența nominală	 Corpul de iluminat se poate monta pe pereții laterali	 Corpul de iluminat se poate monta pe tavan și pe pereții laterali	 Corpul de iluminat se poate încadra în tavanul fals
 Cablul de racord	 Secțiunea conductorului de racord	 Secțiunea cablului de racord	 Grad de protecție
 Durata de viață	 Balast electromagnetic	 Tipul de LED	 Sursa de lumină nu se poate înlocui
 Nu pot fi comandate cu variatoare de flux luminos	 Temperatura mediului ambient	 Domeniul de reglaj al temporizării	 Indicele de redare a culorii
 Se poate tăia	 Numărul de cuplări	 Distanța minimă până la obiectul iluminat	 Unghi flux luminos
 Iluminarea (lux)	 Pot fi comandate cu variatoare de flux luminos	 Conținut de mercur	 Timpul de încălzire
 Balast electronic	 Senzor	 Telecomandă	 Viteză de detecție
 Unghi de detecție	 Tipul soclului	 Tipul soclului	 Tipul soclului



Corpuri de iluminat pentru hale - de interior, LED 6



Corpuri de iluminat pentru exterior, LED 7



Corpuri de iluminat stradal, seria LSJA 8



Corp de iluminat stradal, seria LSJK 8



Corpuri de iluminat stradal, seria LSJC 9



Accesorii 9



Proiectoare LED, seria RSMDDB 10



Proiectoare LED, seria R-SMDH 11



Proiectoare LED, seria R-SMDP 11



Proiector cu LED SMD 12



Proiector cu LED SMD, varianta plată 12



Reflectoare LED portabile / pentru lucrări 13



Reflector halogen oval 14



Reflectoare 15



Reflectoare halogen pentru lucrări 15



Proiectoare cu halogenuri metalice fără balast 16



Surse de lumină cu halogenuri metalice 17



Corpuri de iluminat incorporabile cu LED, rotunde 18



Corpuri de iluminat incorporabile cu LED, rotunde, cu ramă decorativă 18



Corpuri de iluminat incorporabile cu LED, pătrate 19



Corpuri de iluminat aparente cu LED, rotunde 19



Panouri cu LED 20

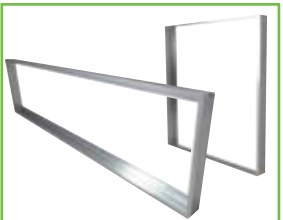

Cadru pentru montajul aparent a panourilor cu LED 21



Alimentator dimabil pentru panouri cu LED 21

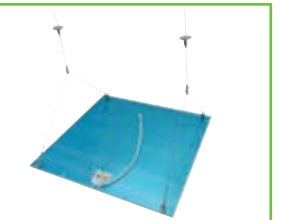

Set de suspensie pentru panouri cu LED 21



Spoturi TLC și accesorii 22



Corpuri de iluminat incastabile cu lămpi fluorescente compacte 22



Corpuri de iluminat din material plastic, de perete, cu detector de mișcare 23



Corpuri de iluminat LED, protejate, de perete 24



Corpuri de iluminat rotunde, de perete, din material plastic 25

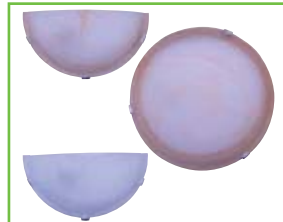

Aplice de perete și de tavan 25



Corpuri de iluminat cu grad de protecție, cu sursă LED 26



Corp de iluminat cu grad de protecție, deschidere cu mâna 26



Corpuri de iluminat cu grad de protecție 27



Corpuri protejate pentru iluminat industrial cu LED-uri 28





Lămpi fluorescente industriale 29



Balast electronic pentru corpuri de iluminat cu tub fluorescent T8 29



Kit de urgență pentru corpuri de iluminat 30



Condensatoare 30



Lampă instalator 31



Corpuri de siguranță- evacuare cu LED 32



CIL de sig-evacuare 33



Corpuri de iluminat plate 34



Corpuri de iluminat de formă triunghiulară 34



Alimentatoare / Accesorii suplimentare 35



Corpuri de iluminat cu LED pentru mobilă, cu carcasă din material plastic 36



Lămpi cu tub fluorescent 37



Lămpi cu tub fluorescent și cu două prize 37



Lămpi cu tub T5 și reflector reglabil 38



Corp de iluminat rotativ cu LED SMD 38



Corp de iluminat cu tub T4 asociabil, pentru mobilă 39



Corp de iluminat pentru tavan cu tub T8 39



Benzi cu LED-uri 40



Seturi de benzi cu LED-uri 41



Controlere LED, miniaturale 41



Controlere LED RGB 42



Alimentatoare pentru LED-uri 42



Bare de aluminiu pentru benzi LED 43

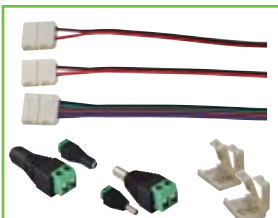

Accesorii pentru benzi cu LED 43



Sursă de lumină LED, răcire cu ulei 45



Surse de lumină COG LED 46



Surse de lumină LED cu formă de pară și sferică 48



Sursă de lumină LED cu formă de lumânare 49



Surse de lumină LED cu formă de reflector 49



Surse de lumină Power Spot LED 50



Sursă SMD, spot (15 x LED) 51



Sursă SMD, spot (12 x LED) 51



Surse de lumină COB LED 52



Surse de lumină COB LED care pot fi comandate prin variațiile de flux luminos 52



Surse de lumină industriale cu LED 53

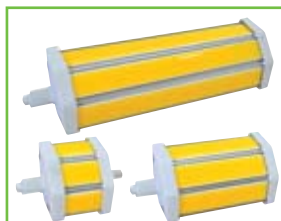

Surse de lumină LED cu soclu R7s 53



Surse de lumină LED cu soclu G9 54



Surse de lumină LED cu soclu G4 54



Tuburi luminoase cu LED 55



Fitlamp 56

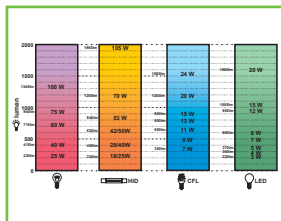

Comparația performanțelor luminoase 58



Lămpi fluorescente compacte, 2U, 3U, 4U 59



Lampă fluorescentă compactă de putere, 4U 59



Lămpi fluorescente compacte, spirală scurtă 60



Lămpi fluorescente compacte, lumânare (GY) 60



Lămpi fluorescente compacte, minispirală 61



Lămpi fluorescente compacte, spirală mică (KS) 61



Lămpi fluorescente compacte, sferă (GL), pară (GLH) 62



Lămpi fluorescente compacte GR10q (2D) 62



Lămpi fluorescente compacte G24d și G24q 63



Adaptor R7s cu lampă fluorescentă compactă 63



Surse halogen liniare (clasa de energie „C”) 64

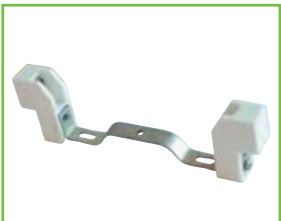

Soclu tip R7s pentru surse halogen liniare 64



Lămpi incandescente halogen 64



Lămpi cu reflector 65



Surse halogen de 12V 65



Soclu din material ceramic pentru surse de joasă tensiune 66



Soclu E27 66



Dulie material ceramic pentru surse de 230 V 66



Surse halogen 230 V dichroice 66



Adaptor rețea pentru surse de lumină MR230 67



Transformatoare electronice 67



Senzori infraroșii de mișcare, încastrați 68



Detector de mișcare tip radar 68



Senzori de mișcare care se pot monta în soclu E27 69



Senzor de mișcare de montat pe tavan 69



Detector infraroșii de mișcare, cu montare pe perete 70



Senzori crepusculari 71



În zilele noastre dezvoltarea tehnologiei LED a atins acel nivel încât iluminatul cu halogenuri metalice răspândit anterior să fie înlocuit cu un iluminat mai eficient, mai economic și ușor de controlat. Economia, ușor de calculat și perioada lungă de garanție asigură amortizarea costurilor de investiție mai ridicate. Corpurile de iluminat cu LED recomandate pentru înlocuirea corpurilor de iluminat cu halogenuri metalice asigură aceeași iluminare a planului de lucru.



Corpurile de iluminat stradale vândute în număr cel mai mare în lume sunt cele cu temperatura de culoare de 4.500 K pe care vi le recomandăm. Corpurile la care temperatura de culoare diferă de această valoare se livrează cu costuri suplimentare. La cerere corpurile de iluminat se pot livra cu surse de alimentare controlabile inteligente!

Cu corpurile de iluminat stradale cu LED se poate economisii în continuare energie electrică prin reglarea fluxului luminos și decuplarea lămpilor care nu se utilizează, respectiv comanda lor cu detectoare de mișcare sau de prezență.

Pentru toate corpurile de iluminat cu LED puteți găsi în magazinul nostru virtual datele tehnice individuale, detaliate care conțin curbele fotometrice, desenele cotate e.t.c.)



CITIȚI CODUL!

- Vezi noutățile noastre
- Fiți informat

**Gama de produse se dezvoltă continuu și rapid!
Catalogul nostru reflectă situația din Mai 2015.
Pentru informații actualizate vizitați pagina
noastră de internet!**

Verificări de tehnica iluminatului și proiecte de iluminat

În laboratorul de iluminat verificăm în mod continuu produsele de tehnica iluminatului asigurând astfel că putem livra întotdeauna produse de bună calitate clienților noștri.

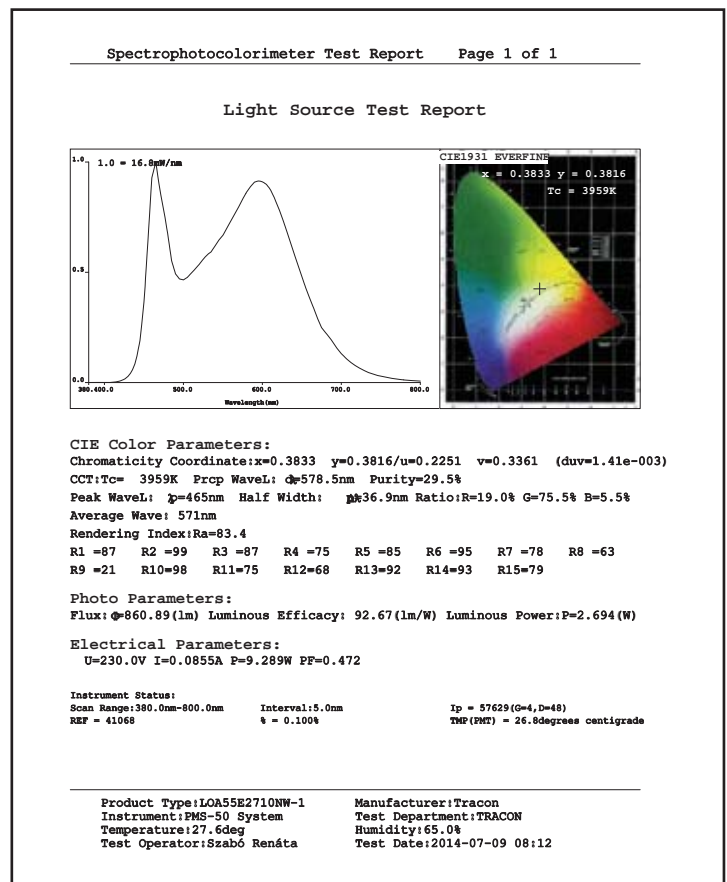
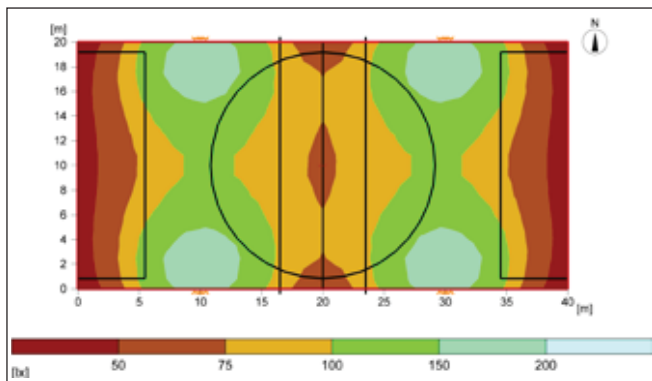
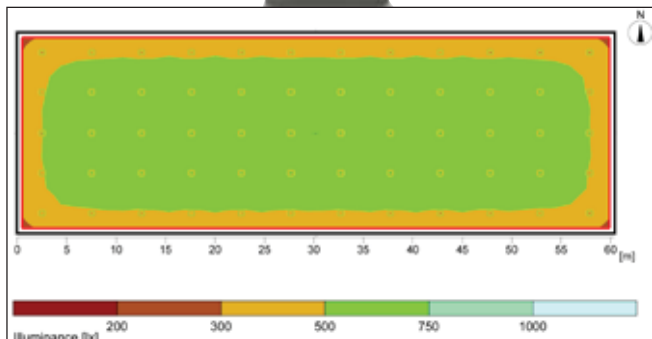
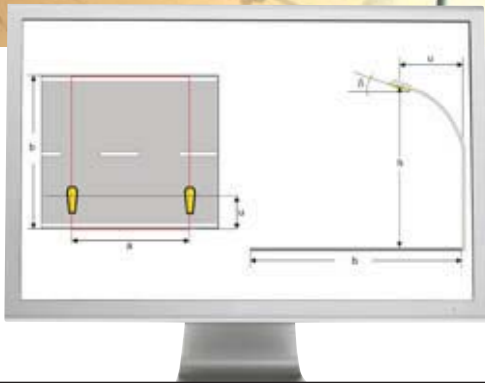
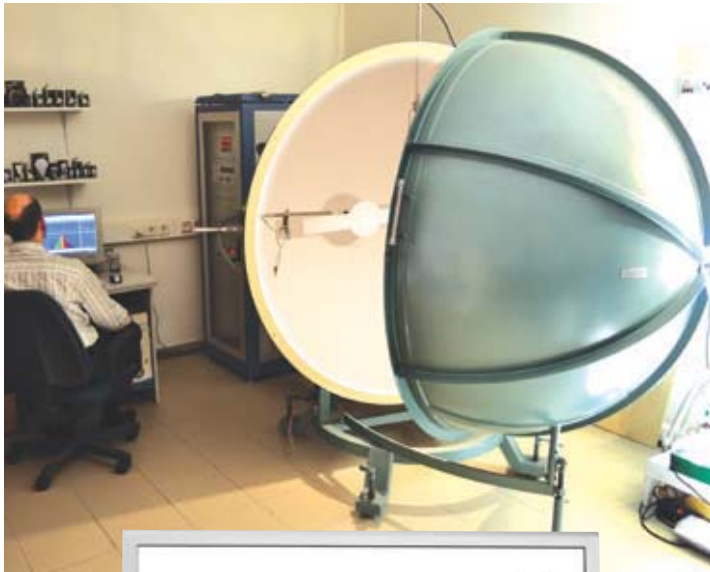

Sprrijinim munca în comun efectuată cu colaboratorii noștri prin proiecte de iluminat realizate în prealabil, utilizînd programul de proiectare RELUX.



În scopul realizării mai facile a proiectelor de iluminat, se pot descărca din magazinul nostru virtual, fișierele cu date fotometrice în format IES ale corpurilor de iluminat profesionale cu LED pentru programele de proiectare utilizate în mod obișnuit (Dialux, Relux).

.ies

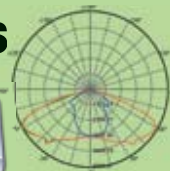
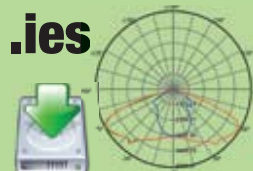

Corpuri de iluminat pentru hale - de interior, LED



TRACON			L E D		T _c [K]	
LHB60W	60 W	150 W		6.000 lm	4.500 K	A+
LHB80W	80 W	200 W		8.000 lm	4.500 K	A+
LHB100W	100 W	250 W		10.000 lm	4.500 K	A+
LHB150W	150 W	400 W		15.000 lm	4.500 K	A+
LHB200W	200 W	500 W		20.000 lm	4.500 K	A
LHB300W	300 W	800 W		30.000 lm	4.500 K	A

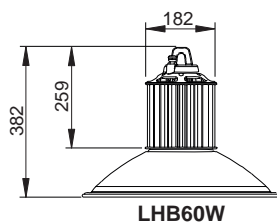

LHB60W

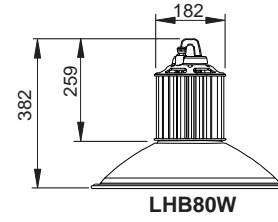

LHB80W

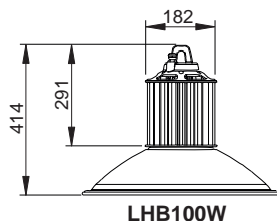

LHB100W

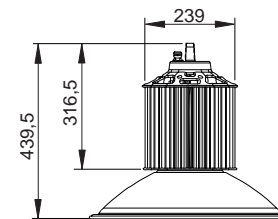

LHB150W

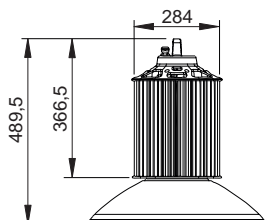

LHB200W

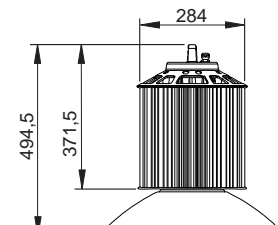

LHB300W

Reflectorul corpurilor de iluminat LHB este inclus, de aceea în momentul efectuării comenzii trebuie precizat de fiecare dată și tipul de reflector! În cazul unei comenzi ulterioare se va percepe și costul reflectorului.

Reflectoare pentru corpurile de iluminat LHB..., pentru hale

TRACON	[°]	D×L
LHBB60	60°	350 × 200 mm
LHBB90	90°	480 × 155 mm
LHBB110	110°	500 × 150 mm

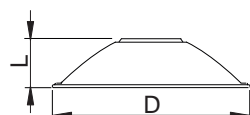

60°



90°



110°

Corpuri de iluminat pentru exterior, LED

90-265 V AC	50/60 Hz	[h] 50.000		≥ 75 Ra	ON-OFF >30.000			EPISTAR LED			Ta -20...+50°C	cos ϕ >0,95
----------------	----------	---------------	--	-----------------	-----------------------	--	--	----------------	--	--	-------------------	---------------------

TRACON	W	LED W	[lm]	Tc [K]	
LHBO80W	80 W	200 W	8.000 lm	4.500 K	A+
LHBO100W	100 W	250 W	10.000 lm	4.500 K	A+
LHBO150W	150 W	400 W	15.000 lm	4.500 K	A+
LHBO200W	200 W	500 W	20.000 lm	4.500 K	A
LHBO300W	300 W	800 W	30.000 lm	4.500 K	A
LHBO400W	400 W	1.000 W	40.000 lm	4.500 K	A
LHBO500W	500 W	1.200 W	50.000 lm	4.500 K	A

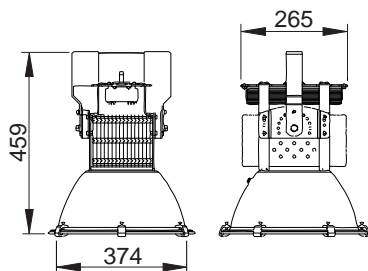

LHBO80W

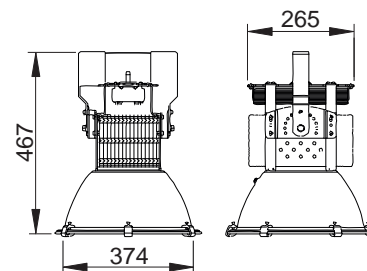

LHBO100W

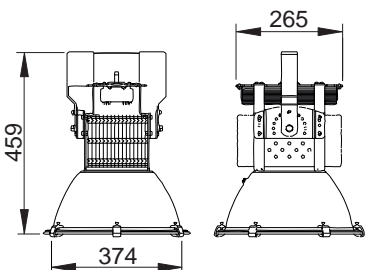

LHBO150W

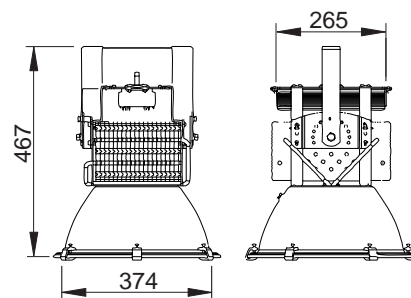

LHBO200W

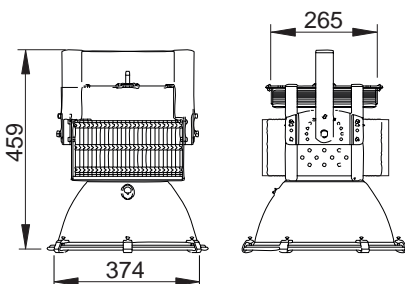

LHBO300W

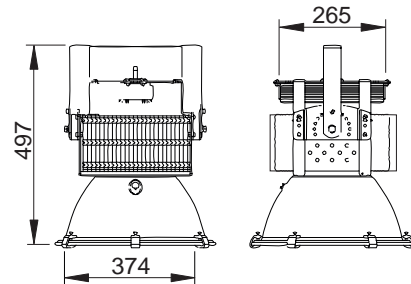

LHBO400W

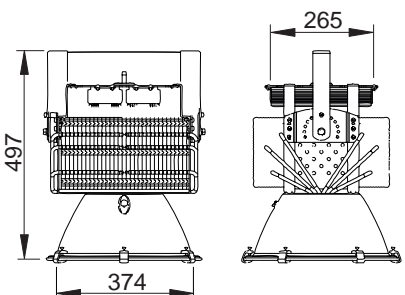

LHBO500W

ÎN CURÂND!

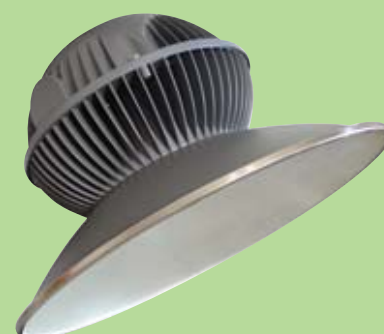

Corpuri de iluminat stradal, seria LSJA



TRACON			L [lm]	Tc [K]		D × H	L (mm)	W (mm)	B (mm)	φ (mm)	
LSJA30W	1 × 30 W	70 W	3.000 lm	4.500 K	Ø 50 mm × 6 m	500	214	81	50	A+	
LSJA50W	1 × 50 W	120 W	5.000 lm	4.500 K	Ø 50 mm × 6 m	500	214	81	50	A+	
LSJA60W	1 × 60 W	150 W	6.000 lm	4.500 K	Ø 50 mm × 6 m	500	214	81	50	A+	
LSJA80W	1 × 80 W	200 W	8.000 lm	4.500 K	Ø 60 mm × 8 m	620	260	101	60	A+	
LSJA100W	2 × 50 W	250 W	10.000 lm	4.500 K	Ø 60 mm × 8 m	700	280	112	65	A	
LSJA120W	2 × 60 W	300 W	12.000 lm	4.500 K	Ø 60 mm × 8 m	700	280	112	65	A	
LSJA150W	3 × 50 W	400 W	15.000 lm	4.500 K	Ø 60 mm × 12 m	880	340	122	65	A	
LSJA180W	3 × 60 W	500 W	18.000 lm	4.500 K	Ø 60 mm × 12 m	880	340	122	65	A	
LSJA200W	4 × 50 W	550 W	20.000 lm	4.500 K	Ø 73 mm × 12 m	1100	420	126	73	A	
LSJA240W	4 × 60 W	600 W	24.000 lm	4.500 K	Ø 73 mm × 12 m	1100	420	126	73	A	

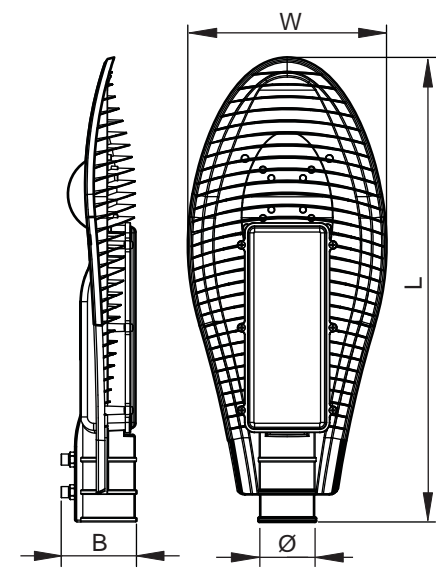

Corp de iluminat stradal, seria LSJK



TRACON			L [lm]	Tc [K]	
LSJK20W	20 W	70 W	2.000 lm	4.500 K	A+

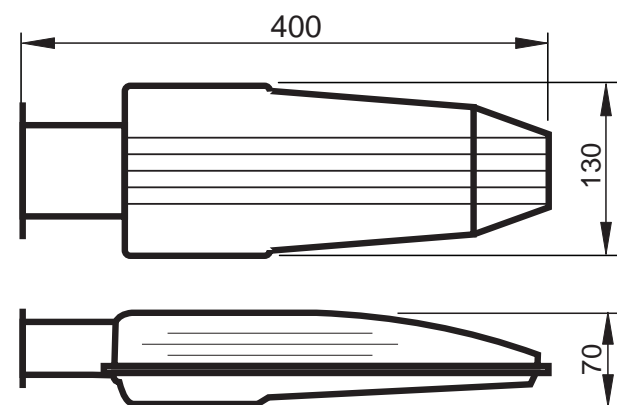

Corpuri de iluminat stradal, seria LSJC

100-240 V AC	50/60 Hz	50.000 [h]		≥ 75 Ra	ON-OFF >30.000			Ta -20...+50°C	cos φ >0,95	100 lm / Watt	4 kV	IP 65
-----------------	----------	------------	--	-----------------	-------------------	--	--	-------------------	------------------------	------------------	------	----------

TRACON						D x H	L (mm)	W (mm)	B (mm)	ϕ (mm)	EI
LSJC50W	1 x 50 W	LED	4.500 lm	4.500 K		\varnothing 50 mm x 6 m	518	228	114	54	A
LSJC60W	1 x 60 W	LED	5.400 lm	4.500 K		\varnothing 50 mm x 6 m	518	228	114	54	A
LSJC100W	1 x 100 W	LED	9.000 lm	4.500 K		\varnothing 60 mm x 8 m	750	322	145	65	A
LSJC120W	1 x 120 W	LED	10.800 lm	4.500 K		\varnothing 60 mm x 8 m	750	322	145	65	A



Accesorii

TRACON



LSJKAV	Adaptor corp de iluminat stradal LSJK pt. țevă orizontală, 50 mm
LSJKAF	Adaptor corp de iluminat stradal LSJK pt. țevă verticală, 50 mm
LSJAA	Adaptor de stâlp pt. corp de iluminat stradal LSJA30/50/60
LSJAA906050	Adaptor reglabil pentru corpuri de iluminat stradal, (0/90°)±10°, 50/60 mm
LSJAA906060	Adaptor reglabil pentru corpuri de iluminat stradal, (0/90°)±10°, 60/60 mm



LSJAA



LSJAA906050



LSJKAV



LSJKAF



CITIȚI CODUL!

- Vezi noutățile noastre
- Fiți informat

Gama de produse se dezvoltă continuu și rapid!
Catalogul nostru reflectă situația din Mai 2015.
Pentru informații actualizate vizitați pagina
noastră de internet!

Proiectoare LED, seria RSMDB



TRACON					L (mm)	W (mm)	B (mm)	
RSMDB10W	10 W	–	850 lm	4.500 K	198	160	45	A
RSMDB20W	20 W	–	1.700 lm	4.500 K	198	160	45	A
RSMDB30W	30 W	70 W	2.550 lm	4.500 K	320	220	61	A
RSMDB50W	50 W	120 W	4.250 lm	4.500 K	320	220	61	A
RSMDB80W	80 W	200 W	6.800 lm	4.500 K	357	320	68	A
RSMDB100W	100 W	250 W	8.500 lm	4.500 K	357	320	68	A
RSMDB120W	120 W	300 W	10.200 lm	4.500 K	450	360	76	A
RSMDB150W	150 W	400 W	12.750 lm	4.500 K	450	360	76	A

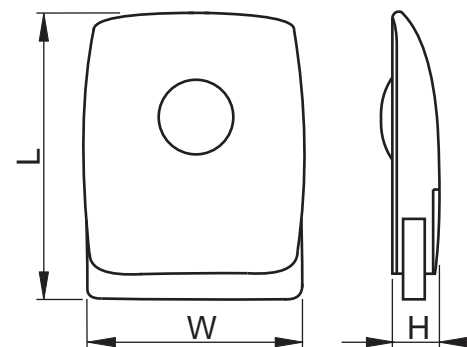

În mod normal proiectorul este livrat cu lentilă optică cu unghiul fluxului luminos de 120°. Dacă sunt necesare proiectoare cu unghiuri diferite de acesta (60°, 90°), acest lucru trebuie precizat în momentul efectuării comenzii.



Proiector LED, seria R-SMDH



TRACON		LED	[lm]	Tc [K]	L (mm)	W (mm)	B (mm)	
R-SMDH-100W	100 W	200 W	8.500 lm	4.500 K	341	250	116	A
R-SMDH-120W	120 W	250 W	10.200 lm	4.500 K	375	310	187	A
R-SMDH-150W	150 W	400 W	12.800 lm	4.500 K	375	310	187	A
R-SMDH-200W	200 W	500 W	17.000 lm	4.500 K	400	340	187	A



R-SMDH-100W
R-SMDH-120W
R-SMDH-150W

R-SMDH-200W

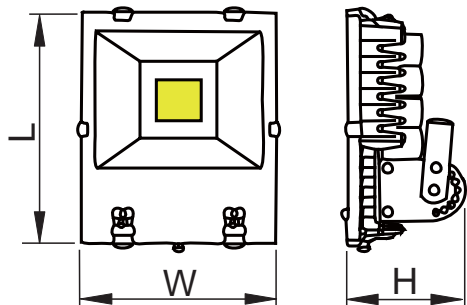

Proiector LED, seria R-SMDP



TRACON		LED	[lm]	Tc [K]	L (mm)	W (mm)	B (mm)	
R-SMDP-50W	50 W	100 W	4.000 lm	4.500 K	323	242	79	A
R-SMDP-80W	80 W	150 W	6.400 lm	4.500 K	323	242	79	A
R-SMDP-100W	100 W	200 W	8.000 lm	4.500 K	461	381	129	A
R-SMDP-200W	200 W	500 W	16.000 lm	4.500 K	630	470	165	A

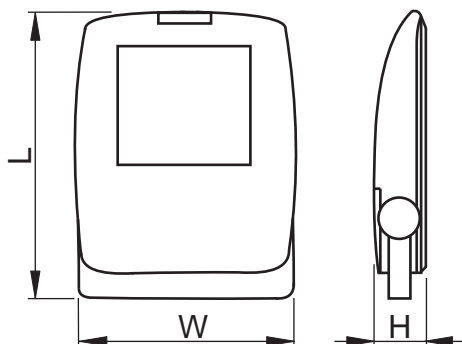

Proiector cu LED SMD

100-240 V AC | 50/60 Hz | 25.000 [h] | | | | SMD LED | 0,5 [m] | | 180° | 3-2.000 lux | 10s-7min

TRACON						L x W x H (mm)	
R-SMD-10W	R-SMDM-10W	10 W	70 W	700 lm	4.500 K	115 x 90 x 86	A
R-SMD-20W	R-SMDM-20W	20 W	150 W	1.400 lm	4.500 K	183 x 142 x 102	A
R-SMD-30W	R-SMDM-30W	30 W	250 W	2.100 lm	4.500 K	227 x 188 x 128	A
R-SMD-50W	R-SMDM-50W	50 W	400 W	3.500 lm	4.500 K	288 x 236 x 146	A

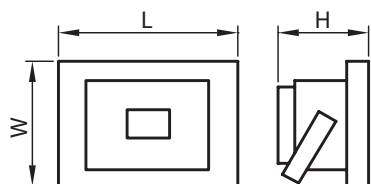
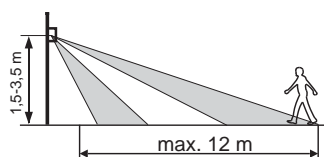

Proiector cu LED SMD, varianta plată

100-240 V AC | 50/60 Hz | 25.000 [h] | | | | SMD LED | 0,5 [m] |

Legendă pictograme **E/O**

TRACON						L x W x H (mm)	
R-SMDL-10W		10 W	70 W	700 lm	4.500 K	120 x 128 x 46	A
R-SMDL-20W		20 W	150 W	1.400 lm	4.500 K	185 x 178 x 55	A
R-SMDL-30W		30 W	250 W	2.100 lm	4.500 K	226 x 230 x 55	A
R-SMDL-50W		50 W	400 W	3.500 lm	4.500 K	286 x 276 x 75	A

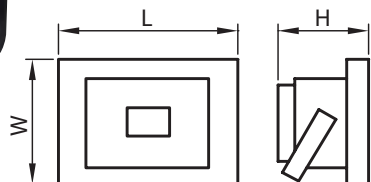

Reflectoare LED portabile / pentru lucrări

100-240 V AC	50/60 Hz	IP 65	Ra ≥75	30.000 [h]	SMD LED	Ta -20..+50°C	3x1,5mm ² 30 cm
-----------------	----------	----------	--------	------------	------------	------------------	-------------------------------

Legendă pictograme **E/0**

TRACON							LI-ION	
RSMDACC10W	10 W	70 W	700 lm	4.500 K	120°	5 h	7.2V/2.2 Ah	A
RSMDACC20W	20 W	150 W	1.400 lm	4.500 K	120°	5 h	14,4V/4,4 Ah	A
RSMDSZ20W	20 W	150 W	1.400 lm	4.500 K	120°	-	-	A
RSMDA220W	2 x 20 W	2x150W	2 x 1.400 lm	4.500 K	120°	-	-	A



TRACON APPLICATION



Proiectoare economice

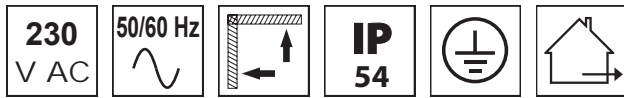

TRACON		L (mm)	W (mm)	H (mm)		
R-E27-2	2 × 60 W	195	255	145	2 × E27	A++, A+, A, B, C, D, E

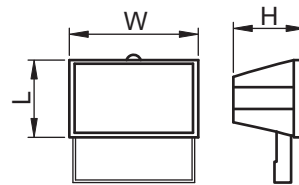

RELEVANT STANDARD
EN 60598

Reflector halogen oval

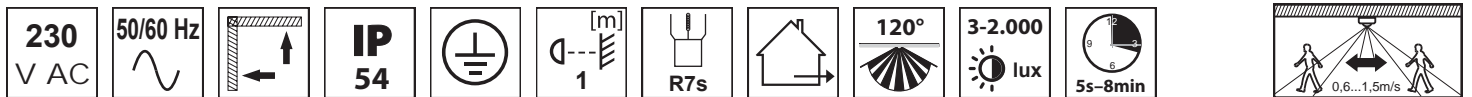

TRACON				L (mm)	W (mm)	H (mm)	I (mm)	
---------------	--	--	--	------------------	------------------	------------------	------------------	--

RK-150	RKM-150	150 W	78 mm	242	140	95	-	A++, A+, A, C, D, E
RK-500	RKM-500	500 W	118 mm	246	180	141	-	
RKL-150	-	150 W	78 mm	358	140	95	118	
RKL-500	-	500 W	118 mm	400	180	141	166	

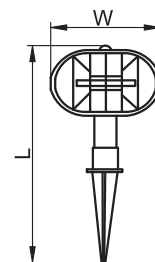
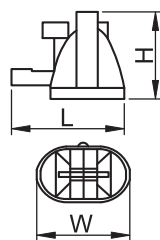
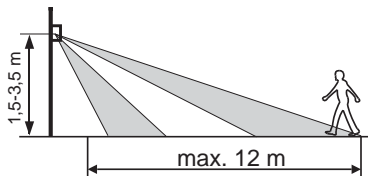

RK-



RKM-

RKL-

Reflectoare

TRACON					
R-150W	RM-150W	150 W		78 mm	A++, A+, A, C, D, E
R-150WFEH	RM-150WFEH	150 W		78 mm	
R-500W	RM-500W	500 W		118 mm	
R-500WFEH	RM-500WFEH	500 W		118 mm	
R-1000W	-	1000 W		189 mm	
R-1000WFEH	-	1000 W		189 mm	

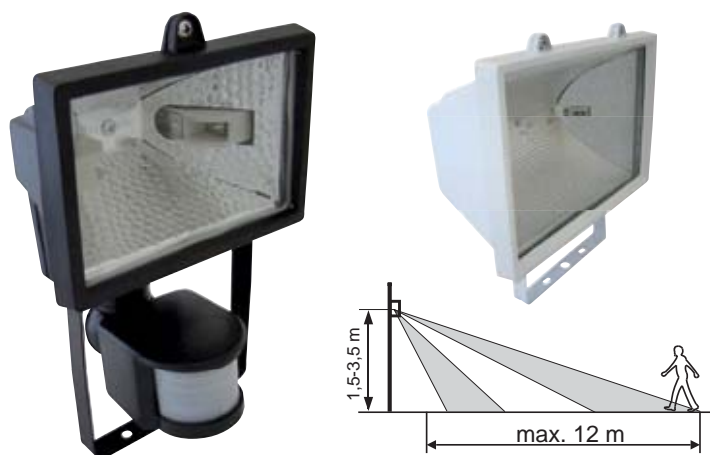

Reflectoare halogen pentru lucrări

TRACON		h (mm)			
RU-150	150 W	-	78 mm	1.2 m	A++, A+, A, C, D, E
RH-150	150 W	-	78 mm	1.2 m	
RH-500	500 W	-	118 mm	1.2 m	
RSZ-500	500 W	-	118 mm	1.2 m	
RA-150	150 W	650-1150	78 mm	2.5 m	
RA-500	500 W	1000-2000	118 mm	3 m	

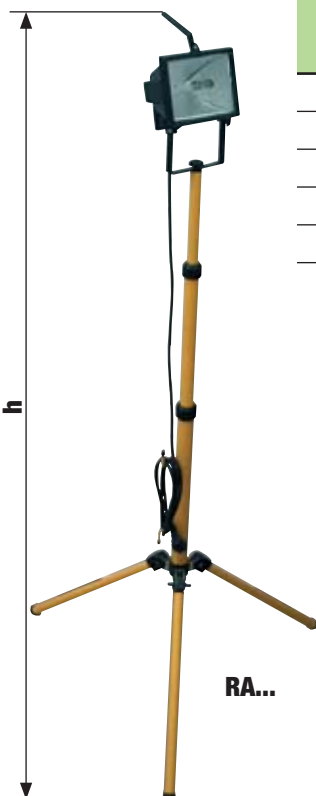

RELEVANT STANDARD
EN 60598



Proiectoare cu halogenuri metalice fără balast

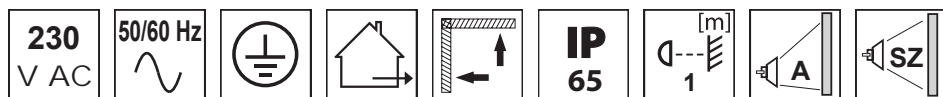

TRACON			L (mm)	W (mm)	H (mm)			
--------	--	--	--------	--------	--------	--	--	--

R-FH-R7S-150A	Rx7s	150 W	435	280	130	A	A	
R-FH-R7S-150SZ	Rx7s	150 W	435	280	130	SZ	A	
R-FH-E27-150A	E27	150 W	435	280	130	A	A	
R-FH-E27-150SZ	E27	150 W	435	280	130	SZ	A	
R-FH-E40-400A	E40	400 W	425	433	147	A	A	
R-FH-E40-400SZ	E40	400 W	425	433	147	SZ	A	

A: asimetric

SZ: simetric



Proiectoare cu halogenuri metalice cu balast încorporat

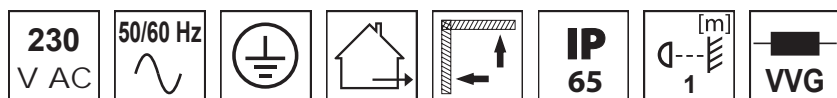

TRACON			L (mm)	W (mm)	H (mm)			
--------	--	--	--------	--------	--------	--	--	--

R-FHSZ-R7S-70A	Rx7s	70 W	435	280	130	A	A	
R-FHSZ-R7S-150A	Rx7s	150 W	435	280	130	A	A	
R-FHSZ-R7S-70SZ	Rx7s	70 W	435	280	130	SZ	A	
R-FHSZ-R7S-150SZ	Rx7s	150 W	435	280	130	SZ	A	
R-FHSZ-E40-250A	E40	250 W	425	433	147	A	A	
R-FHSZ-E40-400A	E40	400 W	425	433	147	A	A	
R-FHSZ-E40-250SZ	E40	250 W	425	433	147	SZ	A	
R-FHSZ-E40-400SZ	E40	400 W	425	433	147	SZ	A	

A: asimetric

SZ: simetric



Balast pentru lămpi cu halogenuri metalice

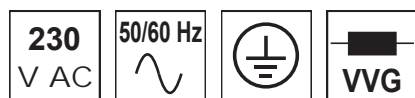

TRACON		I_n
FHE-70	70 W	1 A
FHE-150	150 W	1,8 A
FHE-250	250 W	2,4 A
FHE-400	400 W	3,25 A

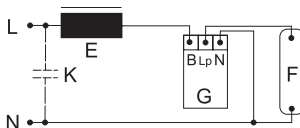

Proiectoare cu halogenuri metalice, rotative

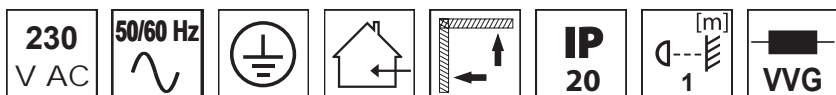

TRACON					
R-FHK-70-FEH		G12	70 W	SZ	A
R-FHK-150-FEH		G12	150 W	SZ	A
R-FHK-70-FEK		G12	70 W	SZ	A
R-FHK-150-FEK		G12	150 W	SZ	A



R-FHK-...

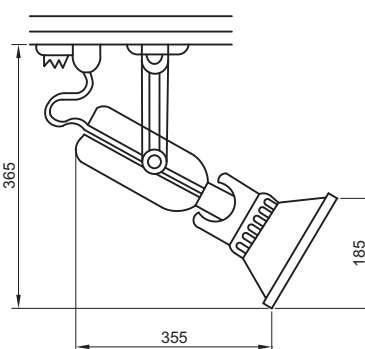

Surse de lumină cu halogenuri metalice

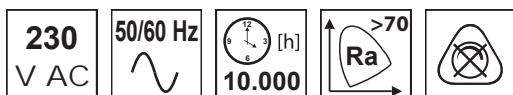

TRACON			L (mm)	W (mm)	Tc [K]		
FHL-R7S-70W	Rx7s	70 W	120	20	6.000 K	5.600 lm	A
FHL-R7S-150W	Rx7s	150 W	138	23	6.000 K	11.250 lm	A
FHL-E27-70W	E27	70 W	141	55	6.000 K	5.600 lm	A
FHL-E27-150W	E27	150 W	141	55	6.000 K	11.250 lm	A
FHL-E40-250W	E40	250 W	257	46	6.000 K	20.500 lm	A
FHL-E40-400W	E40	400 W	283	46	6.000 K	38.000 lm	A



Rx7s

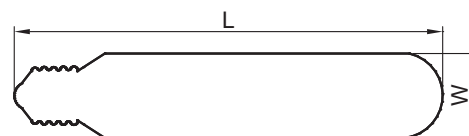

CITIȚI CODUL!

- Vezi noutățile noastre
- Fiți informat

Gama de produse se dezvoltă continuu și rapid!
 Catalogul nostru reflectă situația din Mai 2015.
 Pentru informații actualizate vizitați pagina
 noastră de internet!

Corpuri de iluminat încorporabile cu LED, rotunde

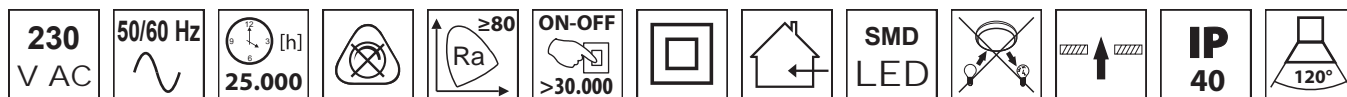

TRACON			LED		Tc [K]		D × H	
LED-DL-6NW	6 W	1 × 13 W		390 lm	4.000 K	110 mm	120 × 20 mm	A
LED-DL-12WW	12 W	1 × 26 W		800 lm	2.700 K	160 mm	174 × 20 mm	A
LED-DL-12NW	12 W	1 × 26 W		800 lm	4.000 K	160 mm	174 × 20 mm	A
LED-DL-18WW	18 W	2 × 26 W		1.200 lm	2.700 K	205 mm	235 × 20 mm	A
LED-DL-18NW	18 W	2 × 26 W		1.200 lm	4.000 K	205 mm	235 × 20 mm	A

Corpurile de iluminat conțin balastul necesar alimentării de la rețea și de asemenea sursele de lumină cu LED, înlocuirea acestora nu este posibilă.

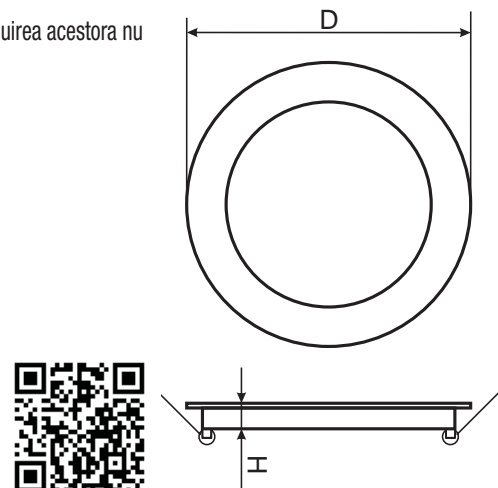

Corpuri de iluminat încorporabile cu LED, rotunde, cu ramă decorativă

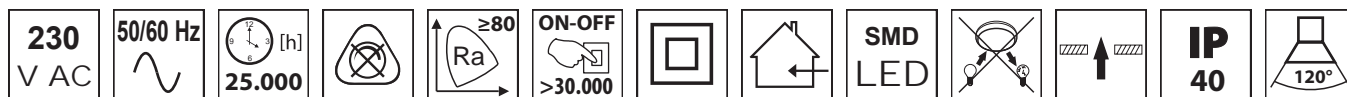

TRACON			LED		Tc [K]		D × H	
LED-DLP-6NW	6 W	1 × 13 W		415 lm	4.000 K	75 mm	95 × 35 mm	A
LED-DLP-12NW	12 W	1 × 26 W		800 lm	4.000 K	130 mm	160 × 35 mm	A
LED-DLP-18NW	18 W	2 × 26 W		1.280 lm	4.000 K	170 mm	200 × 35 mm	A

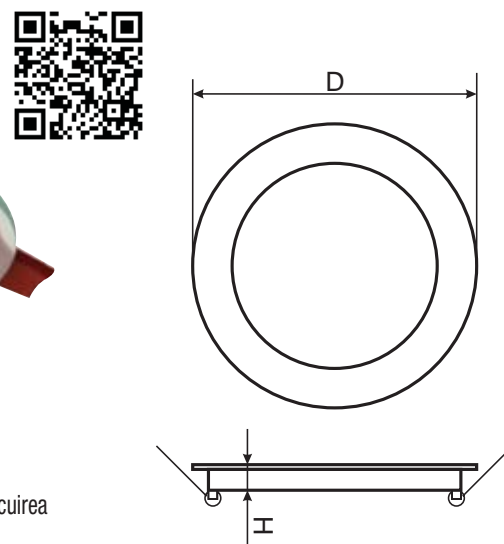

Corpurile de iluminat conțin balastul necesar alimentării de la rețea și de asemenea sursele de lumină cu LED, înlocuirea acestora nu este posibilă.

Corpuri de iluminat încorporabile cu LED, pătrate

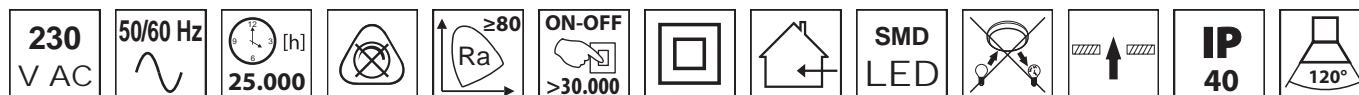

TRACON						D × H	
LED-DLN-6NW	6 W	1 × 13 W	400 lm	4.000 K	110 × 100 mm	120 × 120 × 20 mm	A
LED-DLN-12NW	12 W	1 × 26 W	850 lm	4.000 K	160 × 160 mm	172 × 172 × 20 mm	A
LED-DLN-18NW	18 W	2 × 26 W	1.300 lm	4.000 K	215 × 215 mm	225 × 225 × 20 mm	A

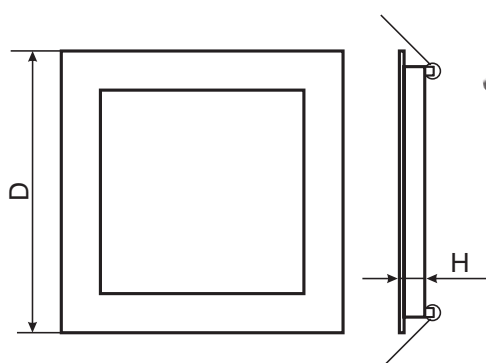

Corpurile de iluminat conțin balastul necesar alimentării de la rețea și de asemenea sursele de lumină cu LED, înlocuirea acestora nu este posibilă.

Corpuri de iluminat aparente cu LED, rotunde

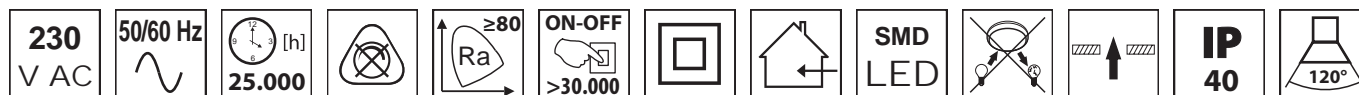

TRACON						D × H	
LED-DLF-6NW	6 W	1 × 13 W	330 lm	4.000 K	-	120 × 37 mm	A
LED-DLF-12NW	12 W	1 × 26 W	800 lm	4.000 K	-	175 × 37 mm	A
LED-DLF-18NW	18 W	2 × 26 W	1.200 lm	4.000 K	-	220 × 37 mm	A
LED-DLF-28NW	28 W	3 × 26 W	1.800 lm	4.000 K	-	300 × 37 mm	A

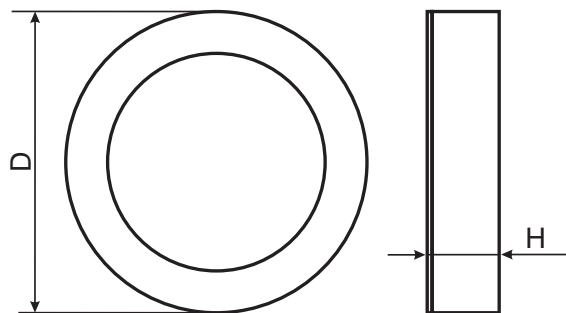

Corpurile de iluminat conțin balastul necesar alimentării de la rețea și de asemenea sursele de lumină cu LED, înlocuirea acestora nu este posibilă.



Panouri cu LED

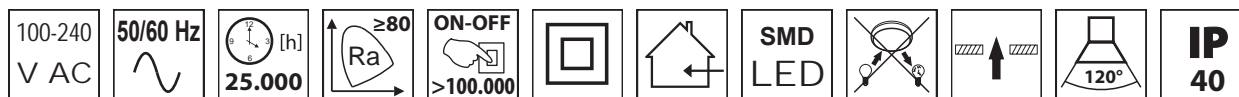

TRACON					L x W x H	
LP303019NW	19 W	2x18 W	1.400 lm	4.000 K	296 x 296 x 11 mm	A
LP606040WW	40 W	4 x 18 W	2.900 lm	2.700 K	596 x 596 x 11 mm	A
LP606040NW	40 W	4 x 18 W	2.900 lm	4.000 K	596 x 596 x 11 mm	A
LPE606050NW	48 W	4 x 18 W	4.000 lm	4.000 K	596 x 596 x 14 mm	A
LP3012040WW	40 W	2 x 36 W	2.900 lm	2.700 K	1.196 x 296 x 11 mm	A
LP3012040NW	40 W	2 x 36 W	2.900 lm	4.000 K	1.196 x 296 x 11 mm	A

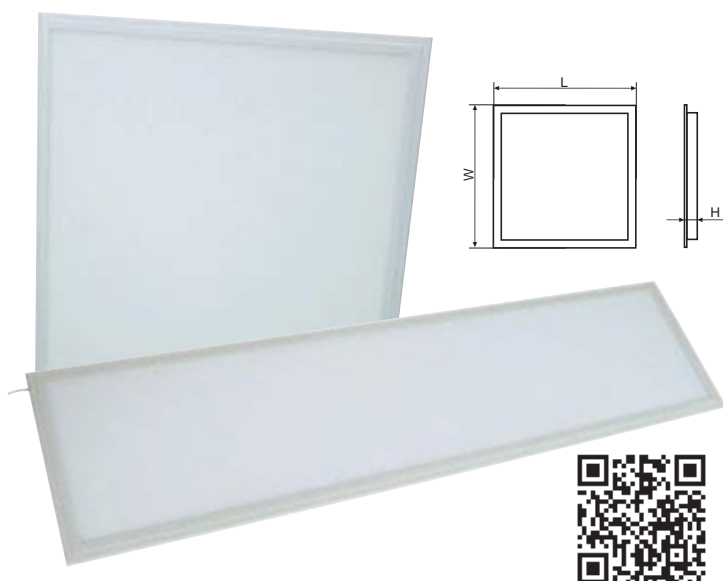

Panourile de formă pătrată cu LED se recomandă pentru iluminarea spațiilor publice, birourilor, atelierelor prevăzute cu tavan fals și se montează încadrat. Panoul de 600x600 mm are exact mărimea unei casete, fiind adecvat pentru înlocuirea corpurilor de iluminat cu tuburi fluorescente 4x18 W. Panoul de 300x1200 mm cu lățimea de jumătate de casetă și cu lungimea de 2 casete se potrivește exact cu dimensiunile corpurilor de iluminat cu tuburi fluorescente 2x36 W; sunt ideale în primul rând pentru iluminarea coridoarelor. Completate cu unitatea **INV-DL-15** panourile pot fi operate opțional ca și corpuri pentru iluminatul de siguranță.

Opțional pentru proiecte sunt disponibile și seturi pentru montarea corpurilor pe tavan sau suspendate precum și variante constructive cu diferite date tehnice (diferite puteri, temperaturi de culoare, culoarea cadrului, dimensiuni, controlul fluxului luminos) care pot fi, de asemenea, comandate.

Cadru și panou posterior: aluminiu
 Panou frontal: policarbonat
 Culoarea cadrului panoului LED: alb



Cadru pentru montajul aparent a panourilor cu LED

TRACON



LP6060K

LP606040NW

LP30120K

LP3012040NW

Cu acest accesoriu panourile cu LED pot fi montate și pe tencuială. Între panou și suprafața de montaj se pot utiliza surse de alimentare cu înălțimea de maxim 32 mm.

Material cadru: Aluminiu

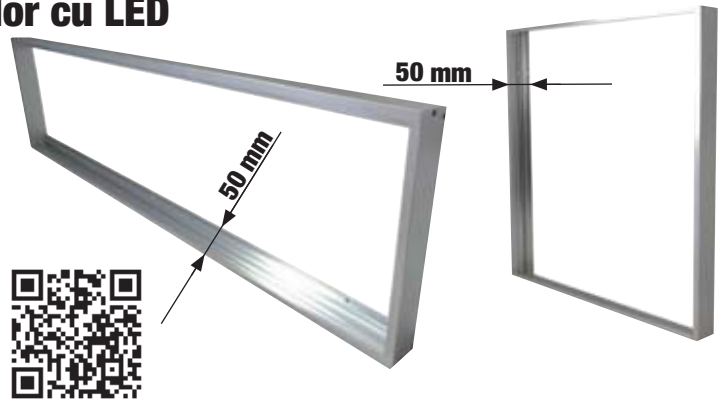

Set de suspensie pentru panouri cu LED

TRACON



LP606040F*

LP606040NW

Lungime 1,5 metri

În cazul unor încăperi cu înălțime mare nu este necesară montarea unui tavan fals deoarece, cu acest accesoriu, panoul LED se poate monta mai jos cu 1,5m!

* numai pentru panourile **LP606040**

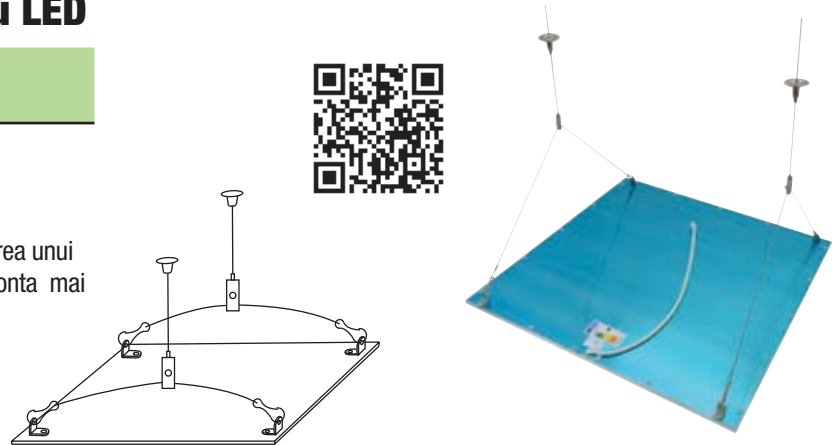

Alimentator dimabil pentru panouri cu LED

TRACON



η %



LPCC40WD

180-240 VAC;
0,23 A

28-42 VDC;
950 mA

> 85 %

Triac
3 – 100 %

Dacă se utilizează acest tip de alimentator, panourile cu LED devin dimabile cu ajutorul unor dispozitive externe speciale (triac).



Verificări de tehnica iluminatului și proiecte de iluminat

În laboratorul de iluminat verificăm în mod continuu produsele de tehnica iluminatului asigurând astfel că putem livra întotdeauna produse de bună calitate clienților noștri.

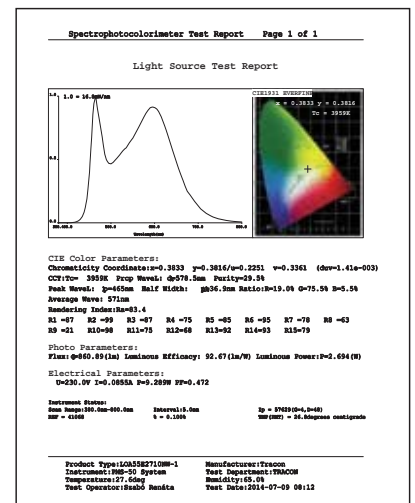
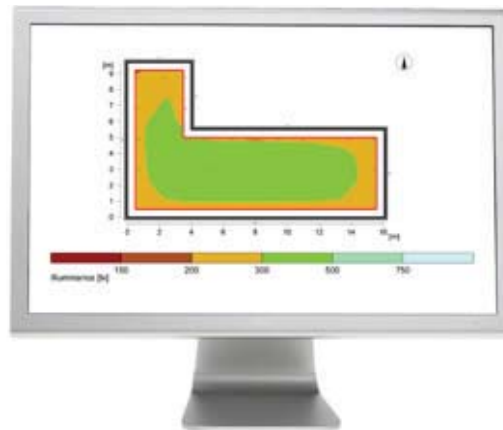

Spriim munca în comun efectuată cu colaboratorii noștri prin proiecte de iluminat realizate în prealabil, utilizând programul de proiectare RELUX.

Spoturi TLC și accesorii



12 V AC/DC	50/60 Hz	III	House icon	IP 20	2x0,5mm 12 cm
G5.3	max. 50 W	Legendă pictograme E/0			

TRACON FIX 30°		Ei	
TLC-2C	TLC-6C		A++, A+, A, B, C, D, E
TLC-2MC	TLC-6MC		A++, A+, A, B, C, D, E
TLC-2MG	TLC-6MG		A++, A+, A, B, C, D, E
TLC-2MR	TLC-6MR		A++, A+, A, B, C, D, E
TLC-2W	TLC-6W		A++, A+, A, B, C, D, E

TLC-2C	TLC-2MC	TLC-2MG	TLC-2W	TLC-6C	TLC-6W	TLC-6MG	TLC-6MR

Corpuri de iluminat încastrabile cu lămpi fluorescente compacte

230 V AC	50/60 Hz	Ta -5..+40 °C	House icon	IP 40	House icon	Legendă pictograme	E/0
----------	----------	---------------	------------	-------	------------	--------------------	-----

TRACON	Light bulb icon	Power (W)	Socket	D (mm)	d (mm)	H (mm)	h (mm)	Mounting	Ei
TLK-15E-E27		max. 26 W	E27	225	205	100	15	215 mm	A++, A+, A, B, C, D, E
TLK-15-2E-E27		max. 2 x 26 W	E27	230	205	100	35	220 mm	A++, A+, A, B, C, D, E

**RELEVANT STANDARD
EN 60598**



Corpuri de iluminat din material plastic, de perete, cu detector de mișcare

230 V AC	50/60 Hz				360°	3-2.000 lux	10s-12min	SMD LED		Legendă pictograme	E/0
-------------	----------	--	--	--	------	----------------	-----------	------------	--	-------------------------------	------------

TRACON				L x W x H D x H (mm)	IP..	[°]	
MFM01*	1 x E27	max. 1 x 25 W	-	Ø 270 x 103	IP 20	360°	A++, A+, A, B, C, D, E
MFM02*	-	16 W	81 x SMD5028	Ø 300 x 112	IP 44	360°	A
MFM03*	2 x E14	max. 2 x 40 W	-	Ø 346 x 87 x 65	IP 44	180°	A++, A+, A, B, C, D, E
MFM04*	-	16 W	96 x SMD5028	Ø 296 x 75	IP 54	360°	A
MF04	-	16 W	96 x SMD5028	Ø 296 x 75	IP 54	-	A
MF05	-	10 W	24 x SMD5028	Ø 275 x 117	IP 20	-	A

*cu detector de mișcare tip radar

MFM04



MFM01, MF05



MFM02



MFM03

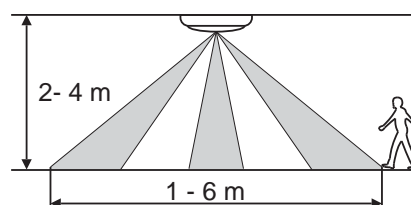
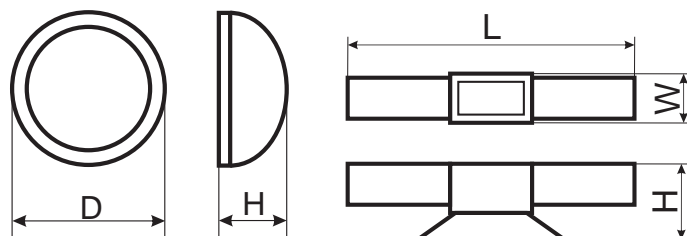

Corpuri de iluminat din material plastic cu LED și detector de mișcare, cu funcții de siguranță

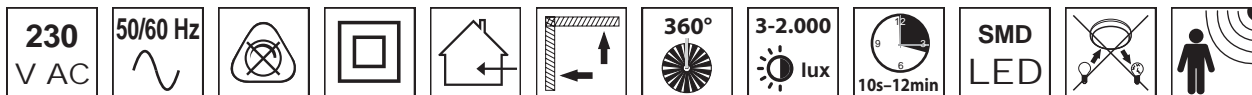

TRACON				D × H (mm)	IP..		
MFM04C	16 / 1,6 W	6 s...30 min.	96 × SMD5028	∅ 296 × 75	IP 54	360°	A
MFM04E	10 / 5 W	10 s...12 min.	56 × SMD5028	∅ 275 × 117	IP 20	360°	A

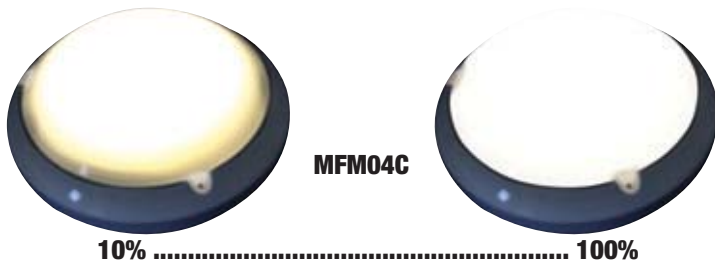

MFM04C este un corp de iluminat cu o lumină de bază și detector de mișcare care în situația de bază funcționează cu 10 % din fluxul luminos, iar în cazul detectării unei mișcări cuplează 100 % fluxul luminos pe durata cât este setată temporizarea. După trecerea timpului de temporizare valoarea fluxului luminos scade înapoi la valoarea de 10%. Marele avantaj al acestui mod de funcționare este că și în locurile fără iluminare naturală corpurile emit o lumină de bază, economică, oferind persoanelor care se deplasează în acest spațiu ghidare suplimentară de siguranță.

MFM04E dispune de acumulator și inverter încorporat, astfel că după întreruperea tensiunii de alimentare corpul de iluminat este capabil să lumineze încă 120 de minute cu putere redusă (30%) în regim de funcționare permanent.

Deoarece în lipsa tensiunii de alimentare funcția de detecție a mișcării este activă, în modul de funcționare intermitent durata de funcționare poate fi de câteva ori mai mare decât în regim permanent!

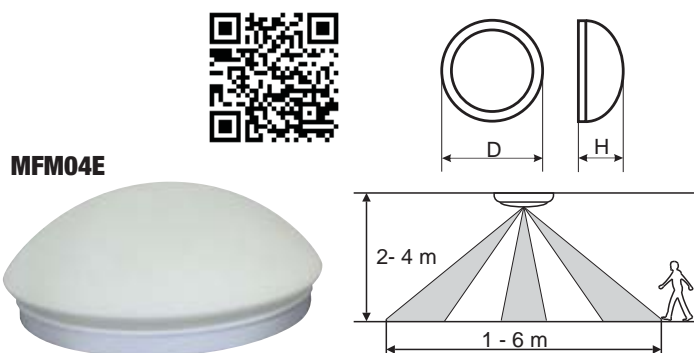

RELEVANT STANDARD
EN 60598

Corpuri de iluminat LED, protejate, de perete



TRACON				Tc [K]	D × H	
LFV40NW	40 W	200 W	3.000 lm	4.000 K	276×86 mm	A
LFV60NW	60 W	300 W	4.200 lm	4.000 K	320×89 mm	A

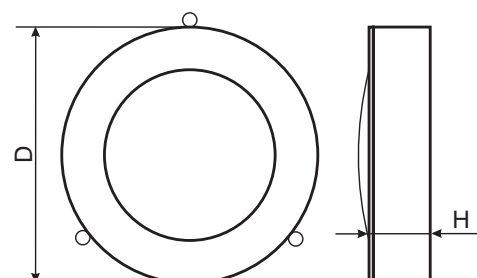

Corpuri de iluminat rotunde, de perete, din material plastic



TRACON					D x H (mm)	IP..		
TLKV-2D-16	○	G10q	16 W	Transparent	-	∅ 270 x 100	IP 54	A
TLKV-2D-21	○	G10q	21 W	Transparent	-	∅ 270 x 100	IP 54	A
TLKV-2D-28	○	G10q	28 W	Transparent	-	∅ 360 x 100	IP 54	A
TLKV-2D-38	○	G10q	38 W	Transparent	-	∅ 360 x 100	IP 54	A
TLKVL-E27	○	E27	max. 60 W	Opal	-	∅ 270 x 100	IP 54	A++, A+, A, B, C, D, E
TLKV-E27	○	E27	max. 60 W	Transparent	-	∅ 270 x 100	IP 54	A++, A+, A, B, C, D, E

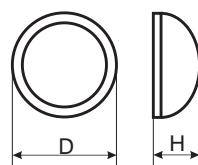

Aplice de perete și de tavan



TRACON				D (mm)		
UFO-1-B		1 x 60 W	1 x E27	∅ 300 mm	○	A++, A+, A, B, C, D, E
UFO-1-F		1 x 60 W	1 x E27	∅ 300 mm	○	A++, A+, A, B, C, D, E
UFO-1-K		1 x 60 W	1 x E27	∅ 300 mm	○	A++, A+, A, B, C, D, E
UFO-1-Z		1 x 60 W	1 x E27	∅ 300 mm	○	A++, A+, A, B, C, D, E
UFO-2-B		2 x 60 W	2 x E27	∅ 300 mm	○	A++, A+, A, B, C, D, E
UFO-2-F		2 x 60 W	2 x E27	∅ 300 mm	○	A++, A+, A, B, C, D, E
UFO-2-K		2 x 60 W	2 x E27	∅ 300 mm	○	A++, A+, A, B, C, D, E
UFO-2-Z		2 x 60 W	2 x E27	∅ 300 mm	○	A++, A+, A, B, C, D, E
UFO-F-B		1 x 60 W	1 x E27	∅ 300 mm	◐	A++, A+, A, B, C, D, E
UFO-F-F		1 x 60 W	1 x E27	∅ 300 mm	◐	A++, A+, A, B, C, D, E
UFO-F-K		1 x 60 W	1 x E27	∅ 300 mm	◐	A++, A+, A, B, C, D, E
UFO-F-Z		1 x 60 W	1 x E27	∅ 300 mm	◐	A++, A+, A, B, C, D, E



Corpuri de iluminat cu grad de protecție, cu sursă LED

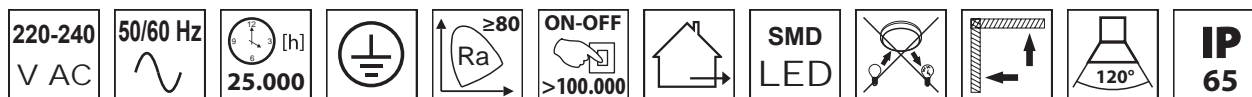

TRACON						
	8 W	60 W	640 lm	4.000 K	170 × 105 × 70 mm	A
LHL08W	8 W	60 W	640 lm	4.000 K	170 × 105 × 70 mm	A
LHLK8W	8 W	60 W	640 lm	4.000 K	168 × 65 mm	A
LHLK12W	12 W	75 W	960 lm	4.000 K	168 × 65 mm	A
LHLK18W	18 W	100 W	1.550 lm	4.000 K	168 × 65 mm	A



Corp de iluminat cu grad de protecție, deschidere cu mâna

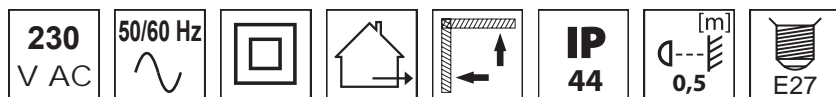

TRACON				
	E27	max. 60 W	180 × 125 × 110 mm	A++, A+, A, B, C, D, E
TLH-08S	E27	max. 60 W	180 × 125 × 110 mm	A++, A+, A, B, C, D, E

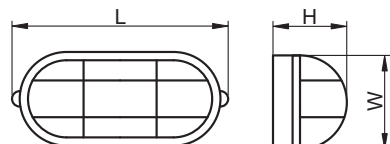
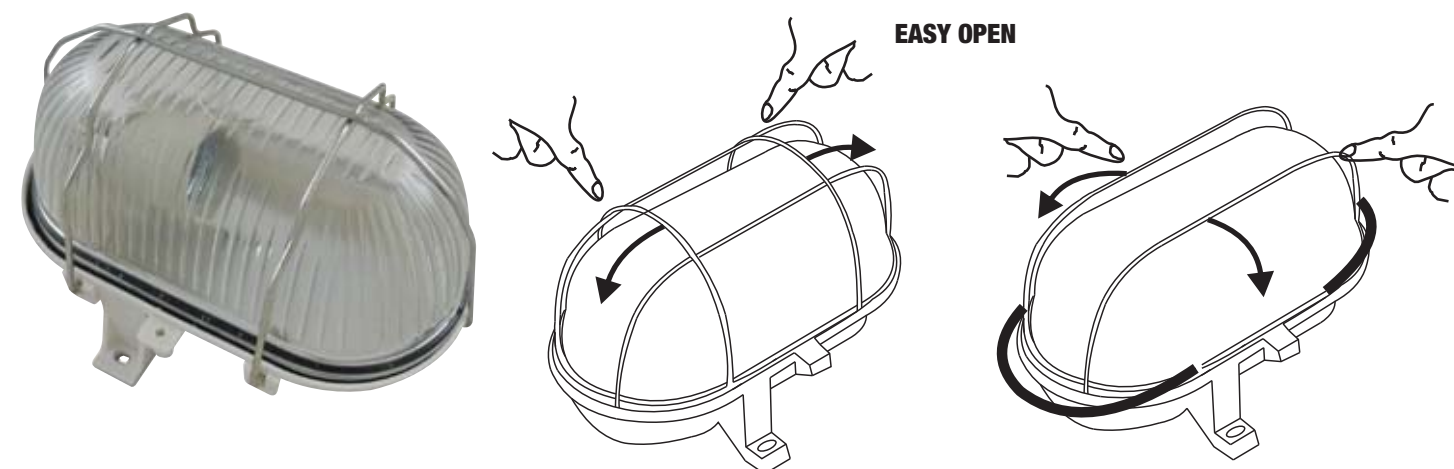

**RELEVANT STANDARD
EN 60598**

Corpuri de iluminat cu grad de protecție

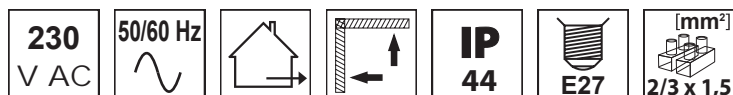

TRACON		Varianta constructivă	L (mm)	W (mm)	H (mm)		Ei
60 W	○ TLH-04	Ovală, carcasă metalică, grilaj metalic	210	105	100	⊕	A++...E
	○ TLH-04W	Ovală, carcasă metalică, grilaj metalic	210	105	100		A++...E
	○ TLH-04RN	Ovală, carcasă metalică, fără grilaj	210	105	100		A++...E
	○ TLH-04RNW	Ovală, carcasă metalică, fără grilaj	210	105	100		A++...E
	○ TLH-04F	Ovală, carcasă metalică, semi acoperit	210	105	100		A++...E
	○ TLH-04FW	Ovală, carcasă metalică, semi acoperit	210	105	100		A++...E
	○ TLH-04FF	Ovală, carcasă metalică, semi acoperit vertical	210	105	100		A++...E
	○ TLH-04FFW	Ovală, carcasă metalică, semi acoperit vertical	210	105	100		A++...E
	○ TLH-05	Rotundă, carcasă metalică, grilaj metalic	190	175	100		A++...E
	○ TLH-05W	Rotundă, carcasă metalică, grilaj metalic	190	175	100		A++...E
	○ TLH-05RN	Rotundă, carcasă metalică, fără grilaj	190	175	100		A++...E
	○ TLH-05RNW	Rotundă, carcasă metalică, fără grilaj	190	175	100		A++...E
	○ TLH-05F	Rotundă, carcasă metalică, semi acoperit	190	175	100		A++...E
	○ TLH-05FW	Rotundă, carcasă metalică, semi acoperit	190	175	100		A++...E
100 W	○ TLH-05KR	Rotundă, carcasă metalică, grilaj metalic circular	190	175	100	A++...E	
	○ TLH-05KRW	Rotundă, carcasă metalică, grilaj metalic circular	190	175	100	A++...E	
	○ TLH-08	Ovală, carcasă și grilaj din material plastic	180	125	110	□	A++...E
	○ TLH-08W	Ovală, carcasă și grilaj din material plastic	180	125	110		A++...E
	○ TLH-08FR	Ovală, carcasă din mat. plastic și grilaj metalic	185	125	113		A++...E
	○ TLH-08FRW	Ovală, carcasă din mat. plastic și grilaj metalic	185	125	113		A++...E
	○ TLH-14	Ovală, carcasă metalică, grilaj metalic	280	160	120	⊕	A++...E
	○ TLH-14W	Ovală, carcasă metalică, grilaj metalic	280	160	120		A++...E
	○ TLH-14RN	Ovală, carcasă metalică, fără grilaj	280	160	120		A++...E
	○ TLH-14RNW	Ovală, carcasă metalică, fără grilaj	280	160	120		A++...E
	○ TLH-14F	Ovală, carcasă metalică, semi acoperit	280	160	120		A++...E
	○ TLH-14FW	Ovală, carcasă metalică, semi acoperit	280	160	120		A++...E
	○ TLH-14FF	Ovală, carcasă metalică, semi acoperit vertical	280	160	120		A++...E
	○ TLH-14FFW	Ovală, carcasă metalică, semi acoperit vertical	280	160	120		A++...E
○ TLH-15	Rotundă, carcasă metalică, grilaj metalic	255	240	130	A++...E		
○ TLH-15W	Rotundă, carcasă metalică, grilaj metalic	255	240	130	A++...E		
○ TLH-15RN	Rotundă, carcasă metalică, fără grilaj	255	240	130	A++...E		
○ TLH-15RNW	Rotundă, carcasă metalică, fără grilaj	255	240	130	A++...E		
○ TLH-15F	Rotundă, carcasă metalică, semi acoperit	255	240	130	A++...E		
○ TLH-15FW	Rotundă, carcasă metalică, semi acoperit	255	240	130	A++...E		
○ TLH-15KR	Rotundă, carcasă metalică, grilaj metalic circular	255	240	130	A++...E		
○ TLH-15KRW	Rotundă, carcasă metalică, grilaj metalic circular	255	240	130	A++...E		
○ TLH-100	Rotundă, carcasă din material plastic	245	245	90	□	A++...E	
○ TLH-100W	Rotundă, carcasă din material plastic	245	245	90		A++...E	

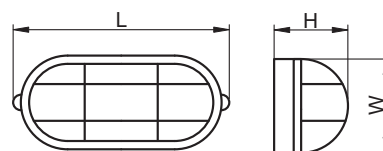

Corpuri protejate pentru iluminat industrial cu LED-uri

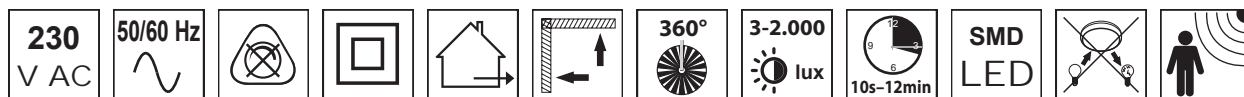

TRACON					LxWxH		
TLFVL18W	18 W	36 W	1.440 lm	4.500 K	600 × 86 × 65	280 × SMD3528	A
TLFVLM18W*	18 W	36 W	1.440 lm	4.500 K	600 × 86 × 65	280 × SMD3528	A

*cu detector de mișcare tip radar

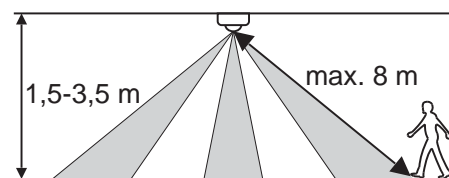
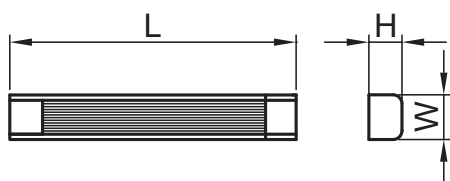

Corpuri de iluminat protejate pentru tuburi luminoase cu LED

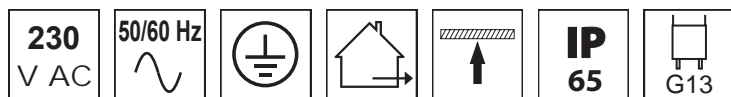

TRACON				L x W x H (mm)	
TLFVLED212	2 × 36 W	2 × 1200 mm	× 10	1270 × 140 × 100	A++, A+, A
TLFVLED215	2 × 58 W	2 × 1500 mm	× 12	1565 × 140 × 100	A++, A+, A

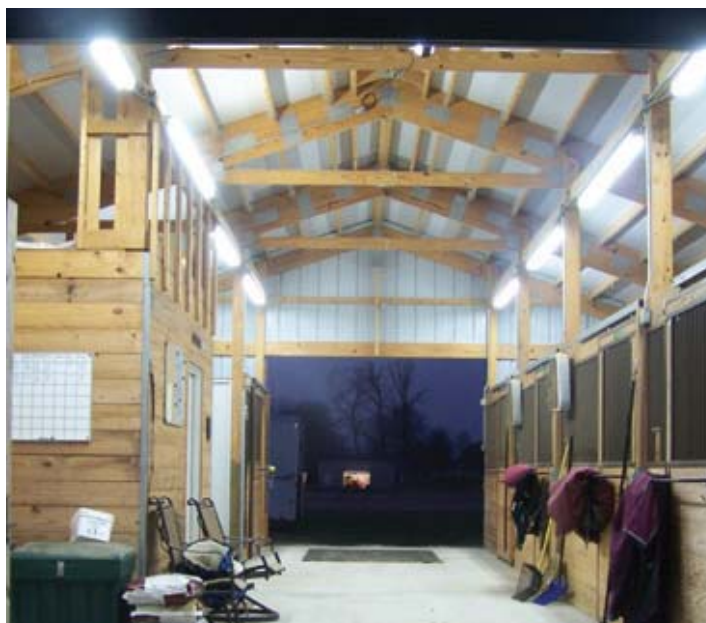
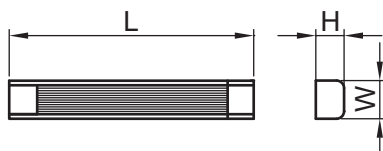
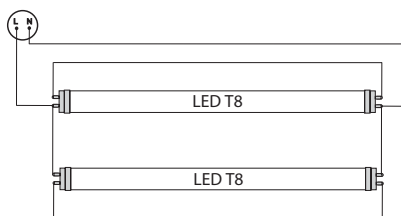

Lămpi fluorescente industriale

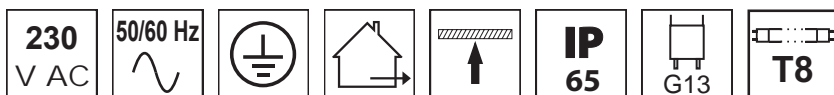

TRACON				L x W x H (mm)	
EVG					
TLFV-118E	1 x 18 W	6	655 x 72 x 86	A	
TLFV-136E	1 x 36 W	10	1265 x 72 x 86	A	
TLFV-158E	1 x 58 W	12	1565 x 72 x 86	A	
TLFV-218E	2 x 18 W	6	655 x 115 x 86	A	
TLFV-236E	2 x 36 W	10	1265 x 115 x 86	A	
TLFV-258E	2 x 58 W	12	1565 x 115 x 86	A	

TRACON				L x W x H (mm)	
VVG					
TLFV-118M	1 x 18 W	6	655 x 89 x 92	A	
TLFV-136M	1 x 36 W	10	1265 x 89 x 92	A	
TLFV-158M	1 x 58 W	12	1565 x 89 x 92	A	
TLFV-218M	2 x 18 W	6	655 x 130 x 92	A	
TLFV-236M	2 x 36 W	10	1265 x 130 x 92	A	
TLFV-258M	2 x 58 W	12	1565 x 130 x 92	A	

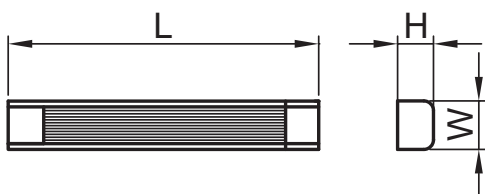

RELEVANT STANDARD
EN 60928



Balast electronic pentru corpuri de iluminat cu tub fluorescent T8

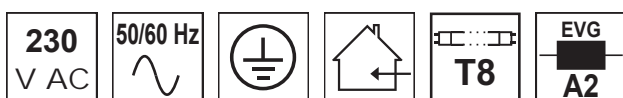

TRACON		L (mm)	W (mm)	H (mm)
TLFV-EE-118	1 x 18 W	275	28	27
TLFV-EE-136	1 x 36 W	275	28	27
TLFV-EE-158	1 x 58 W	320	32	28
TLFV-EE-218	2 x 18 W	275	28	27
TLFV-EE-236	2 x 36 W	320	32	28
TLFV-EE-258	2 x 58 W	320	32	28
TLFV-EE-418	4 x 18 W	332	33	28

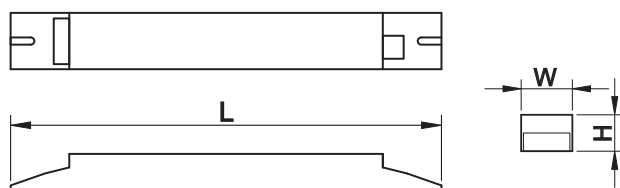

RELEVANT STANDARD
EN 60598



Kit de urgență pentru corpuri de iluminat

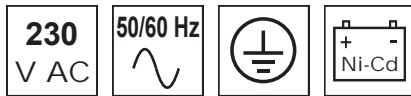

TRACON	T5	T8	[h]	V	Ah
INV-1418	14 W	18 W	1,5 h	3,6 V	2.400 mAh
INV-2836	28 W	36 W	1,5 h	4,8 V	2.400 mAh
INV-3558	35 W	58 W	1,5 h	6 V	2.400 mAh
INV-1418-15	14 W	18 W	0,5 h	3,6 V	1.500 mAh
INV-2836-15	28 W	36 W	0,5 h	4,8 V	1.500 mAh
INV-3558-15	35 W	58 W	0,5 h	6 V	1.500 mAh
INV-2D28-45*	*Pentru TLKV-2D-28, TLKV-2D-38 vezi pag. 25.		0,5 h	3,6 V	4.500 mAh
INV-DL-15**	** Pentru panouri LED până la 50 W, vezi pag. 18.		0,5 h	19,2 V	1.500 mAh

Încorporarea unităților complementare cu invertor în corpurile de iluminat cu tuburi fluorescente face posibilă ca la întreruperea tensiunii acestea să funcționeze ca și corp pentru iluminatul de siguranță.

Aceste unități sunt compuse din două părți. Invertorul asigură funcționarea sursei de lumină în cazul prezenței tensiunii, iar în lipsa tensiunii comută automat sursa de lumină pe acumulatorul încorporat. La revenirea tensiunii recuplarea se face tot automat.

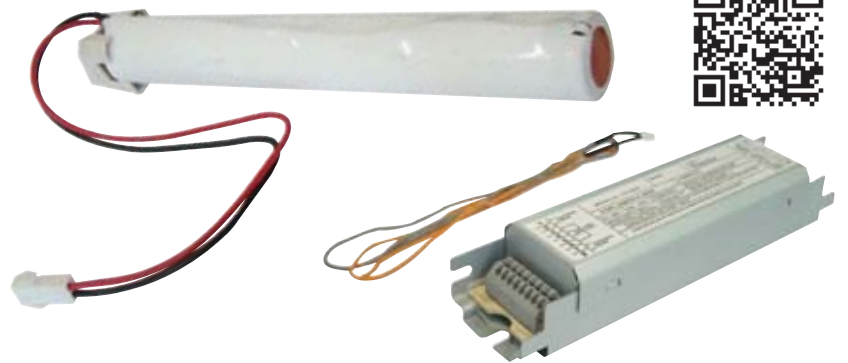

**RELEVANT STANDARD
EN 60598**

Condensatoare

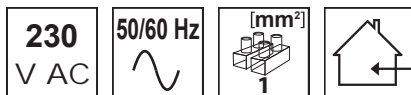

TRACON					C (μF)	H (mm)	D (mm)
					2	55	25
TLKC-2010	TLKC-2011	TLKC-2012	TLKC-2021	TLKC-2022	4	55	25
TLKC-4010	TLKC-4011	TLKC-4012	TLKC-4021	TLKC-4022	4,5	55	25
TLKC-4510	TLKC-4511	TLKC-4512	TLKC-4521	TLKC-4522	7	75	25
TLKC-7010	TLKC-7011	TLKC-7012	TLKC-7021	TLKC-7022	8	75	25
TLKC-8010	TLKC-8011	TLKC-8012	TLKC-8021	TLKC-8022	9	67	30
TLKC-9010	TLKC-9011	TLKC-9012	TLKC-9021	TLKC-9022			

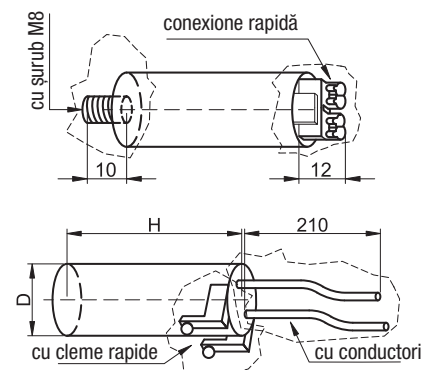

Lampă instalator

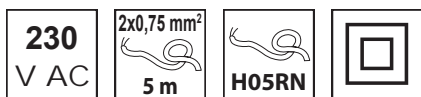

TRACON			
STL-02	—	8 W	A
STL-03	E27	60 W	A++, A+, A,
STL-04	E27	60 W	B, C, D, E



STL-02 Lampă instalator



STL-03 Lampă instalator cu protecție de metal



STL-04 Lampă instalator cu protecție de material plastic

LED lampă instalator

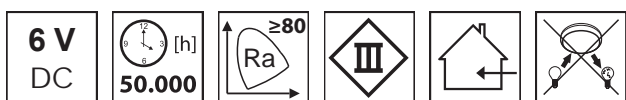

TRACON					
STL-05	5.4 W	× 61	4 h	6 V	A



Corpuri de siguranță-evacuare cu LED

230 V AC 50/60 Hz **IP 20**

Legendă pictograme **E/O**

TRACON	[W]	[h]	[lm]	x	V	Ah		L (mm)	W ₁ (mm)	W ₂ (mm)	H (mm)	
EXIT-01-J	4 W	3 h	240 lm	x 13	2.4 V	900 mAh	Ni-Cd	350	60	220	30	A
EXIT-02-J	3 W	3 h	180 lm	x 8	2.4 V	900 mAh	Ni-Cd	240	60	210	25	A
EXIT-03-J	6 W	3 h	360 lm	x 18	3.6 V	900 mAh	Ni-Cd	340	25	185	65	A

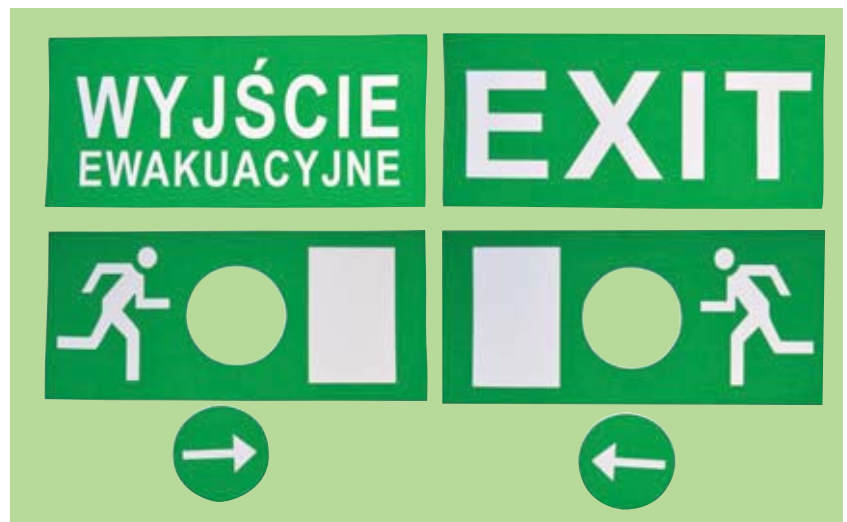
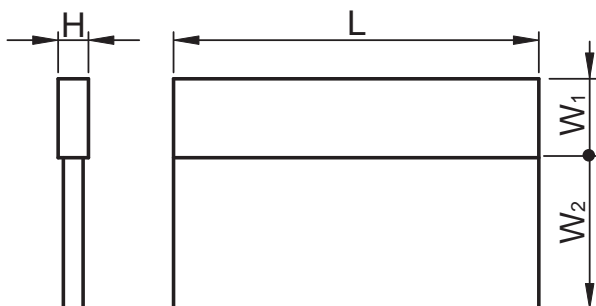

CIL de sig-evacuare

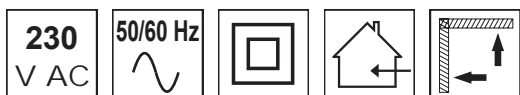

TRACON							L x W x H (mm)	IP..		
TLBV-18A	8 W	G5 (T5)	1 h	2,4 V	1,5 Ah	Ni-Cd	350 x 117 x 76	IP 65	M	A
TLBV-18M	8 W	G5 (T5)	3 h	2,4 V	5 Ah	Ni-Cd	350 x 117 x 76	IP 65	M	A
TLBV-18NM	8 W	G5 (T5)	3 h	2,4 V	5 Ah	Ni-Cd	350 x 117 x 76	IP 65	NM	A
TLBVLED30	4 W	-	3 h	4,8 V	900 mAh	Ni-Cd	350 x 117 x 76	IP 65	M	A



Asigură iluminarea căilor de evacuare în cazul deranjamentelor din rețeaua de alimentare normală. Corpurile de regim **permanent (M)** la întreruperea tensiunii rețelei de alimentare după timpul de comutare scurt rămân în continuare funcționale.

Cele de regim **nepermanent (NM)** funcționează doar în cazul întreruperii tensiunii rețelei de alimentare. Timpul de comutare este mai mic de 1 secundă.

TRACON



TLBV-18-KJ Placă înclichetabilă pentru indicarea căilor de evacuare la montajul pe tavan a corpurilor TLBV-18, săgeată în lateral

TLBV-18-KL Placă înclichetabilă pentru indicarea căilor de evacuare la montajul pe tavan a corpurilor TLBV-18, săgeată în jos

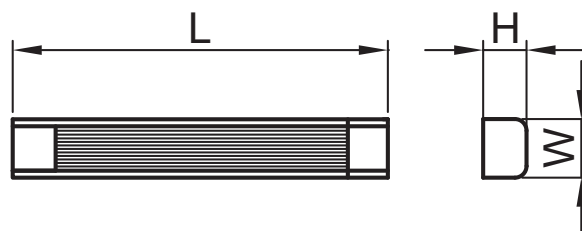
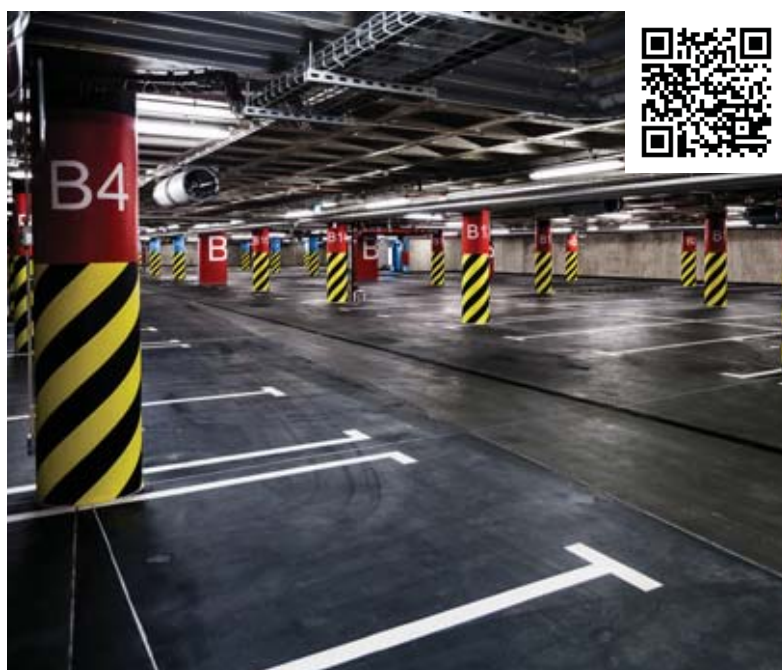

Corpuri de iluminat plate

12 V DC, 50.000 [h], Ra ≥80, ON-OFF >30.000, III, house icon, SMD LED, no dimmer icon, mounting icon, wireless icon, Legendă pictograme, E/O

TRACON					L x W x H (mm)		
LLBS5WW	5 W	10 W	420 lm	3.000 K	500 x 29 x 8	72 x SMD3528	A
LLBS5NW	5 W	10 W	470 lm	4.000 K	500 x 29 x 8	72 x SMD3528	A
LLBS5CW	5 W	10 W	470 lm	6.000 K	500 x 29 x 8	72 x SMD3528	A
LLBS11WW	11 W	18 W	800 lm	3.000 K	1000 x 29 x 8	144 x SMD3528	A
LLBS11CW	11 W	18 W	870 lm	6.000 K	1000 x 29 x 8	144 x SMD3528	A

Corpurile de iluminat plate se pot înseria drept și curb totodată, cu ajutorul elementelor suplimentare de înseriere. Corpurile de iluminat plate se recomandă a fi montate pe o suprafață plană.

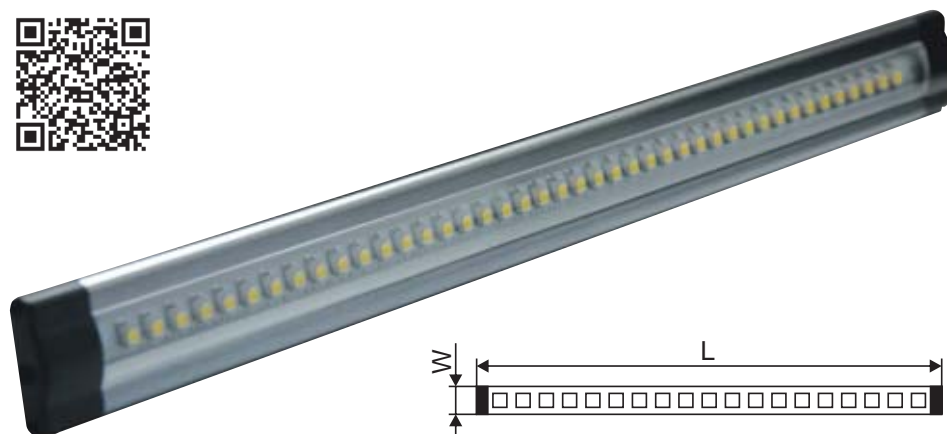

Corpuri de iluminat cu LED pentru mobilă, carcasă metalică, formă triunghiulară

12 V DC, 50.000 [h], Ra ≥80, ON-OFF >30.000, III, house icon, SMD LED, no dimmer icon, mounting icon, wireless icon, Legendă pictograme, E/O

TRACON					L x W x H (mm)		
LSBS5WW	5 W	10 W	420 lm	3.000 K	500 x 32 x 19.7	72 x SMD3528	A
LSBS5CW	5 W	10 W	470 lm	6.000 K	500 x 32 x 19.7	72 x SMD3528	A
LSBS11WW	11 W	18 W	800 lm	3.000 K	1000 x 32 x 19.7	144 x SMD3528	A
LSBS11CW	11 W	18 W	870 lm	6.000 K	1000 x 32 x 19.7	144 x SMD3528	A
LSBS5WWT	5 W	10 W	420 lm	3.000 K	500 x 32 x 19.7	72 x SMD3528	A
LSBS5CWT	5 W	10 W	470 lm	6.000 K	500 x 32 x 19.7	72 x SMD3528	A

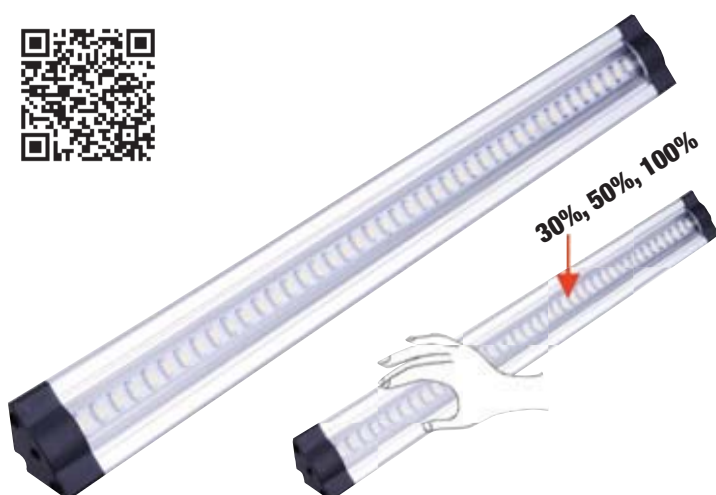

Variantele constructive de formă triunghiulară se pot înseria doar drept cu ajutorul elementelor suplimentare de asociere. Aceste unități se recomandă a se fixa în colțul dintre mobilă și perete.

Corpurile de iluminat de formă triunghiulară al căror cod se termină cu litera „T” se pot conecta prin atingerea carcasei metalice și în același timp prin glisarea mâinii se poate regla fluxul luminos.

Funcția de „cuplare prin atingere” nu poate fi transmisă în continuare prin înseriere!

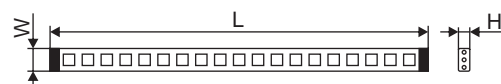



Accesorii pentru corpuri de iluminat LED pentru mobilă, cu carcasă metalică

Surse de alimentare

TRACON	U_n	
LED-CVD-24W	230 V / 12 V	24 W
LED-CVD-48W	230 V / 12 V	48 W
LED-CVL-24W	230 V / 12 V	24 W
LED-CVL-48W	230 V / 12 V	48 W
LED-CVL-96W	230 V / 12 V	96 W

LED-CVD



LED-CVL



Înterupătoare

TRACON	
LBSKK	ON-OFF
LBSKD	ON-OFF TOUCH (30-50-100%)
LBSKT	ON-OFF TOUCH (30-50-100%) + LBSR (opțional)
LBSR	Telecomandă LBSKT

LBSKK



LBSKD,
LBSKT



LBSR



Elemente de inseriere

TRACON	
LBSTK	-
LBSC05	L = 0,5 m
LBSC1	L = 1 m
LBSC41	1:4
LBSC61	1:6



Îmbinare
curbă



Cablu
distribuție



Cablu
prelungitor drept

Corpuri de iluminat cu LED pentru mobilă, cu carcasă din material plastic

230 V AC	50/60 Hz				IP 20	≥ 80	2 x 0,5mm 1,2 m	ON-OFF >30.000	[h] 30.000	SMD LED	Hg 0 mg	$T_{up} < 1s$
--------------------	----------	--	--	--	------------------------	-----------	--------------------	--------------------------	---------------	--------------------------	--------------------------	---------------

TRACON			[lm]	[K]	L x W x H (mm)	
LBV4W	4 W	5 W	350 lm	4.500 K	300x22x35	A+
LBV7W	7 W	8 W	600 lm	4.500 K	600x22x35	A+
LBV9W	9 W	12 W	800 lm	4.500 K	900x22x35	A+
LBV18W	18 W	24 W	1.600 lm	4.500 K	1200x22x35	A+

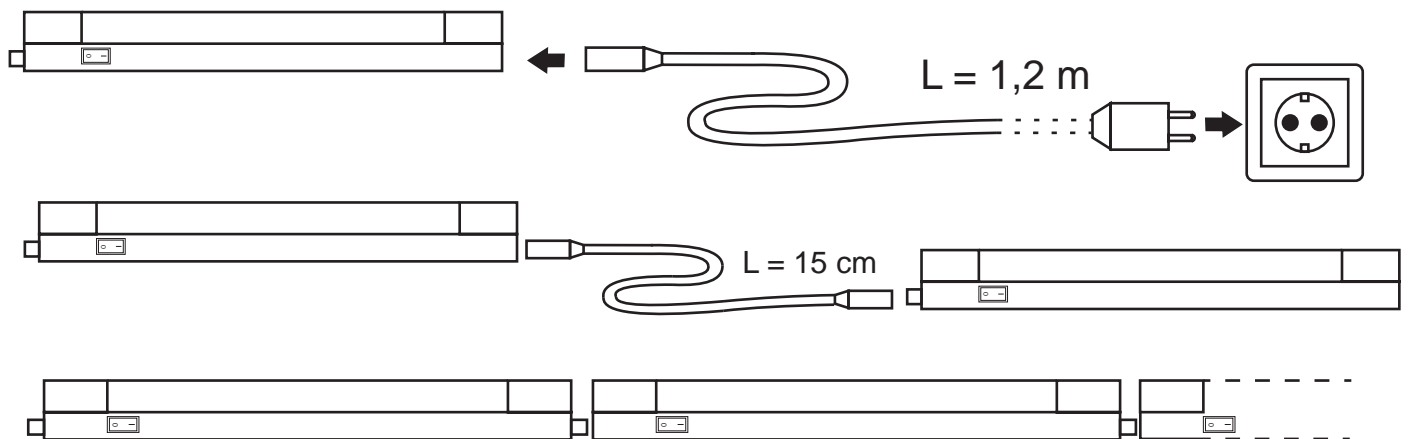
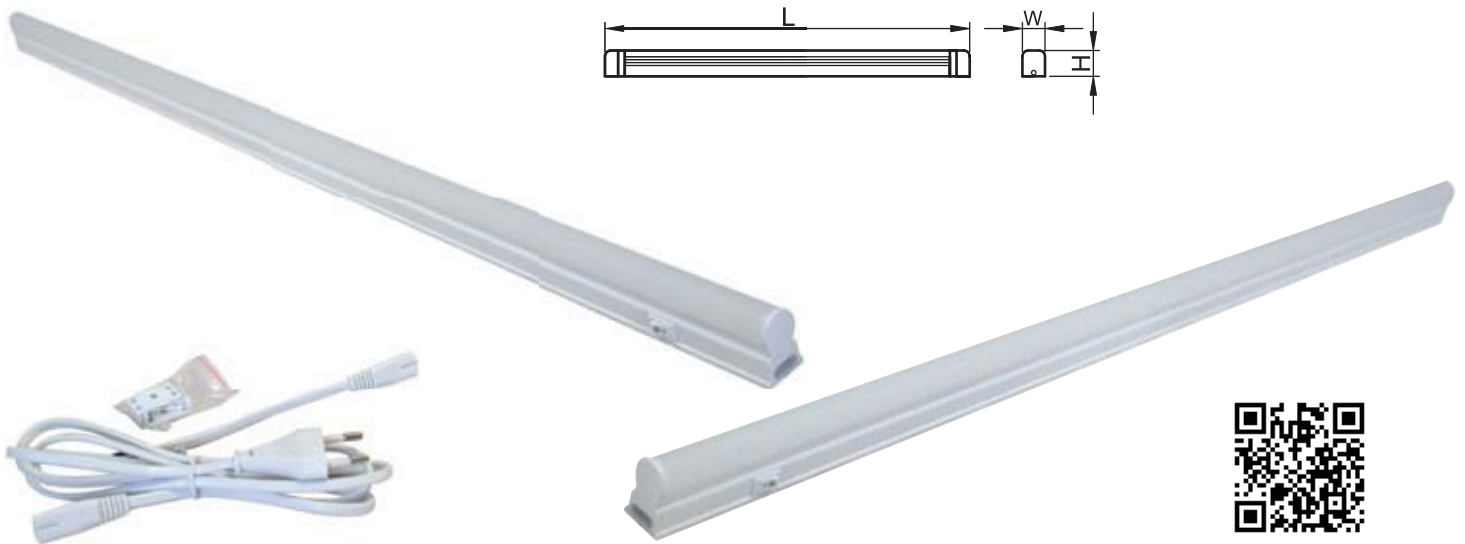

Key to electricity

TRACON
.....**ELECTRIC**

Tracon Key to electricity

Lămpi cu tub fluorescent

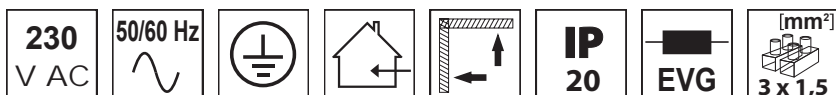

TRACON				Tc [K]	L (mm)	W (mm)	H (mm)	
TLL-10	G13	10 W	T8	6.400 K	412	34	64	A
TLL-15	G13	15 W	T8	6.400 K	516	34	64	A
TLL-18	G13	18 W	T8	6.400 K	669	34	64	A
TLL-30	G13	30 W	T8	6.400 K	973	34	64	A
TLL-36	G13	36 W	T8	6.400 K	1270	34	64	A

Tuburile fluorescente sunt incluse în corpul de iluminat.

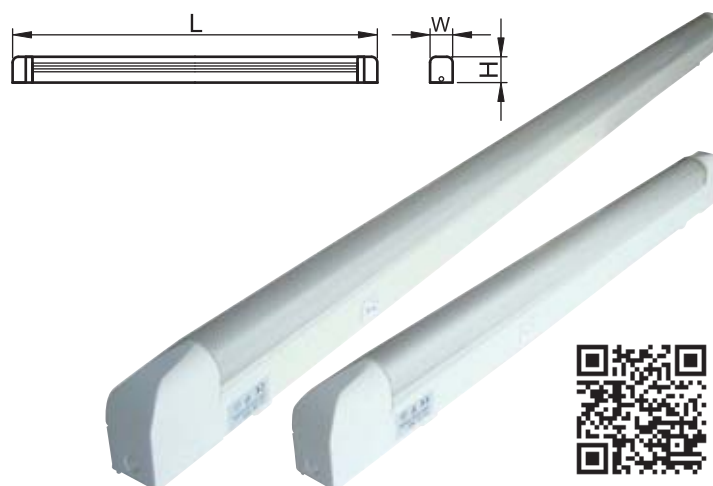

Lămpi cu tub fluorescent și cu două prize

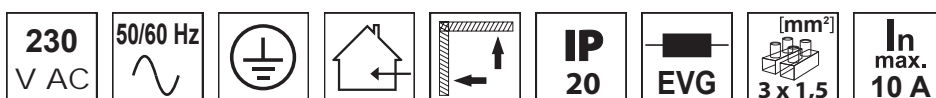

TRACON					Tc [K]	L (mm)	W (mm)	H (mm)	
TLFL-10	TLFL-10F	G13	10 W	T8	6.400 K	500	80	60	A
TLFL-15	TLFL-15F	G13	15 W	T8	6.400 K	600	80	60	A
TLFL-18	TLFL-18F	G13	18 W	T8	6.400 K	750	80	60	A
TLFL-30	TLFL-30F	G13	30 W	T8	6.400 K	1060	80	60	A

Tuburile fluorescente sunt incluse în corpul de iluminat.

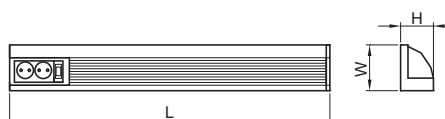

**RELEVANT STANDARD
EN 60598**



Lămpi cu tub T5 și reflector reglabil

Legendă pictograme
E/0

TRACON					L (mm)	W (mm)	H (mm)	
FLF-T5-8W	G5	8 W	T5	6.400 K	363	100	35	A
FLF-T5-14W	G5	14 W	T5	6.400 K	625	100	35	A
FLF-T5-21W	G5	21 W	T5	6.400 K	923	100	35	A
FLF-T5-28W	G5	28 W	T5	6.400 K	1225	100	35	A

Tuburile fluorescente sunt incluse în corpul de iluminat.

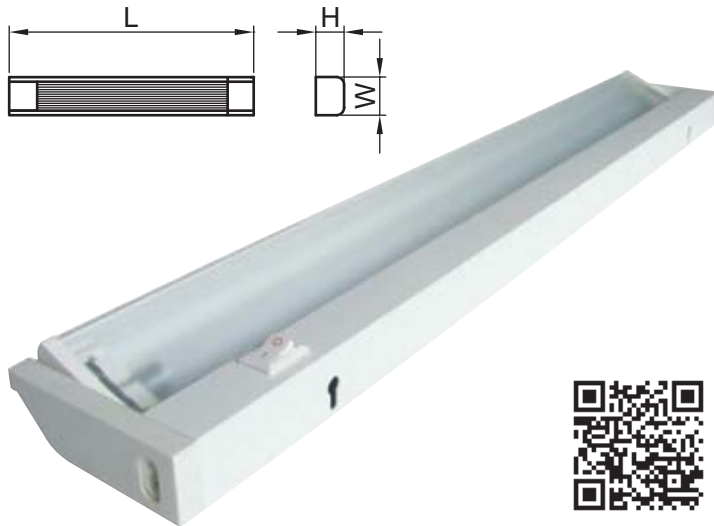

Corp de iluminat rotativ cu LED SMD

Legendă pictograme
E/0

TRACON			L (mm)	W (mm)	H (mm)	
FLF-LED-20	3,5 W	× 20	360	100	35	A



Corp de iluminat cu tub T5 asociabil, pentru mobilă

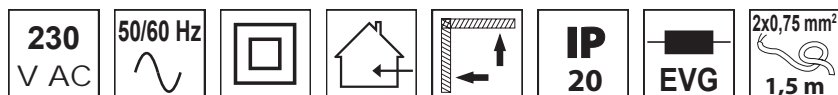

TRACON				Tc [K]	L (mm)	W (mm)	H (mm)	
FLT58W	G5	8 W	T5	6.400 K	358	22	42	A
FLT513W	G5	13 W	T5	6.400 K	585	22	42	A
FLT521W	G5	21 W	T5	6.400 K	915	22	42	A
FLT528W	G5	28 W	T5	6.400 K	1215	22	42	A
FLT535W	G5	35 W	T5	6.400 K	1515	22	42	A

Aceste corpuri ies în evidență față de celelalte corpuri de iluminat cu tub fluorescent datorită dimensiunilor reduse. Corpurile de iluminat se pot înșira unul în celălalt cu ajutorul deschizăturii și pinului de asociere sau prin cablul de înșierare atașat, cu lungimea de 15 cm. Tubul fluorescent se montează în cadrul de fixare din material plastic, livrat odată cu corpul de iluminat. Corpurile de iluminat au balast electronic inclus. Tuburile fluorescente sunt incluse în corpul de iluminat.

**RELEVANT STANDARD
EN 60598**

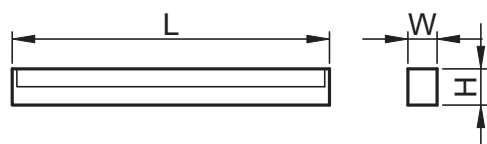

Corp de iluminat pentru tavan cu tub T8

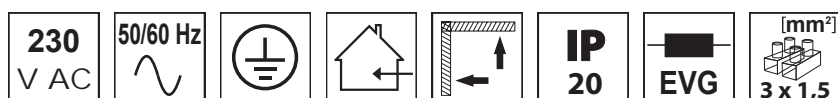

TRACON				Tc [K]	L (mm)	W (mm)	H (mm)	
MFL-T8-115W	G13	1 × 15 W	T8	6.400 K	505	114	45	A
MFL-T8-118W	G13	1 × 18 W	T8	6.400 K	655	114	45	A
MFL-T8-130W	G13	1 × 30 W	T8	6.400 K	960	114	45	A
MFL-T8-136W	G13	1 × 36 W	T8	6.400 K	1265	114	45	A
MFL-T8-218W	G13	2 × 18 W	T8	6.400 K	655	140	50	A
MFL-T8-230W	G13	2 × 30 W	T8	6.400 K	960	140	50	A
MFL-T8-236W	G13	2 × 36 W	T8	6.400 K	1265	140	50	A

Tuburile fluorescente sunt incluse în corpul de iluminat.

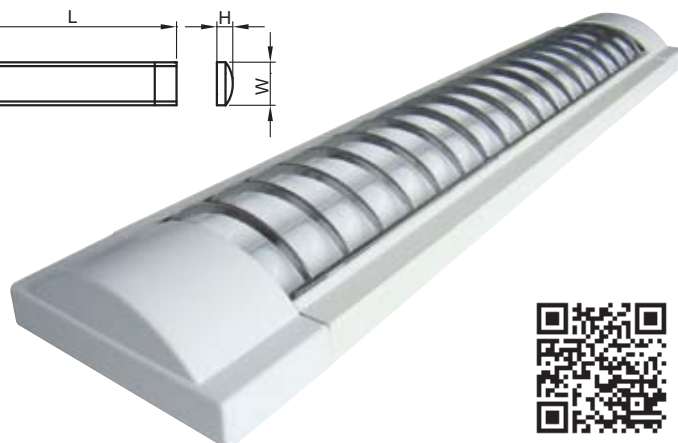
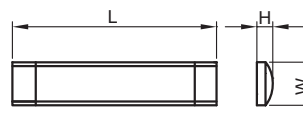
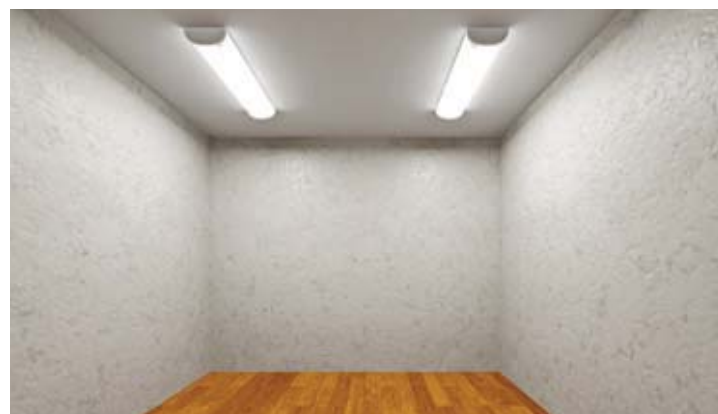

Benzi cu LED-uri

12 V DC	[h] 50.000	ON-OFF >30.000		SMD LED			Hg 0 mg	T _{up} <1s		Legendă pictograme	E/0
------------	---------------	-------------------	--	------------	--	--	------------	---------------------	--	---------------------------	------------

TRACON	(W)	(lm)	W	T _c [K]	IP..	L E D
LED-SZ-48-WW	4,8 W / m	180 lm / m	8 mm	3.000 K	IP 20	60 × SMD3528 / m
LED-SZ-48-CW	4,8 W / m	200 lm / m	8 mm	6.000 K	IP 20	60 × SMD3528 / m
LED-SZK-48-WW	4,8 W / m	180 lm / m	8 mm	3.000 K	IP 65	60 × SMD3528 / m
LED-SZK-48-NW	4,8 W / m	180 lm / m	8 mm	4.000 K	IP 65	60 × SMD3528 / m
LED-SZK-48-CW	4,8 W / m	200 lm / m	8 mm	6.000 K	IP 65	60 × SMD3528 / m
LED-SZK-72-WW	7,2 W / m	310 lm / m	10 mm	3.000 K	IP 65	30 × SMD5050 / m
LED-SZK-72-NW	7,2 W / m	330 lm / m	10 mm	4.000 K	IP 65	30 × SMD5050 / m
LED-SZK-72-CW	7,2 W / m	320 lm / m	10 mm	6.000 K	IP 65	30 × SMD5050 / m
LED-SZK-72-RGB	7,2 W / m	–	10 mm	RGB	IP 65	30 × SMD5050 / m
LED-SZ-96-WW	9,6 W / m	360 lm / m	8 mm	3.000 K	IP 20	120 × SMD3528 / m
LED-SZ-96-CW	9,6 W / m	400 lm / m	8 mm	6.000 K	IP 20	120 × SMD3528 / m
LED-SZ-144-WW	14,4 W / m	600 lm / m	10 mm	3.000 K	IP 20	60 × SMD5050 / m
LED-SZ-144-CW	14,4 W / m	640 lm / m	10 mm	6.000 K	IP 20	60 × SMD5050 / m
LED-SZ-144-RGB	14,4 W / m	–	10 mm	RGB	IP 20	60 × SMD5050 / m
LED-SZTR-144-WW	14,4 W / m	330 lm / m	10 mm	3.000 K	IP 20	30 × SMD5050 / m
LED-SZTR-144-CW	14,4 W / m	360 lm / m	10 mm	6.000 K	IP 20	30 × SMD5050 / m
LED-SZK-144-WW	14,4 W / m	600 lm / m	10 mm	3.000 K	IP 65	60 × SMD5050 / m
LED-SZK-144-NW	14,4 W / m	330 lm / m	10 mm	4.000 K	IP 65	60 × SMD5050 / m
LED-SZK-144-CW	14,4 W / m	640 lm / m	10 mm	6.000 K	IP 65	60 × SMD5050 / m
LED-SZK-144-RGB	14,4 W / m	–	10 mm	RGB	IP 65	60 × SMD5050 / m

Benziile cu LED-uri se fabrică în primul rând în scop decorativ. Cu ajutorul lor iluminatul decorativ se poate realiza ușor, ieftin și simplu în gospodării, magazine și în locuri publice.

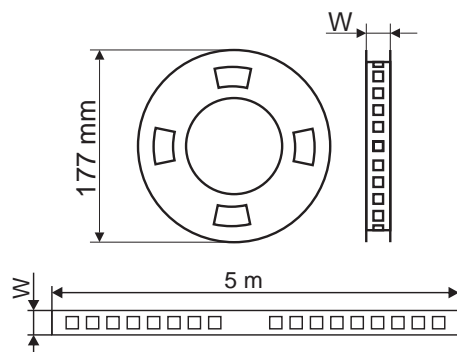

Seturi de benzi cu LED-uri

12 V DC	[h] 50.000	ON-OFF >30.000		SMD LED		120°	Hg 0 mg	T _{up} <1s		Legendă pictograme E/0
TRACON	[W]	[lm]	W	T _c [K]	IP..	L E D				
LED-SET-B-WW	4,8 W / m	120 lm / m	8 mm	3.000 K	IP 20	30 × SMD3528 / m				
LED-SET-K-RGB	14,4 W / m	450 lm / m	10 mm	RGB	IP 65	60 × SMD5050 / m				

Benziile cu LED-uri sunt disponibile și în set. Acesta conține toate unitățile necesare pentru funcționare, astfel montajul este rapid și simplu. Parametrii tehnici principali sunt aceiași ca și la benziile cu LED-uri.

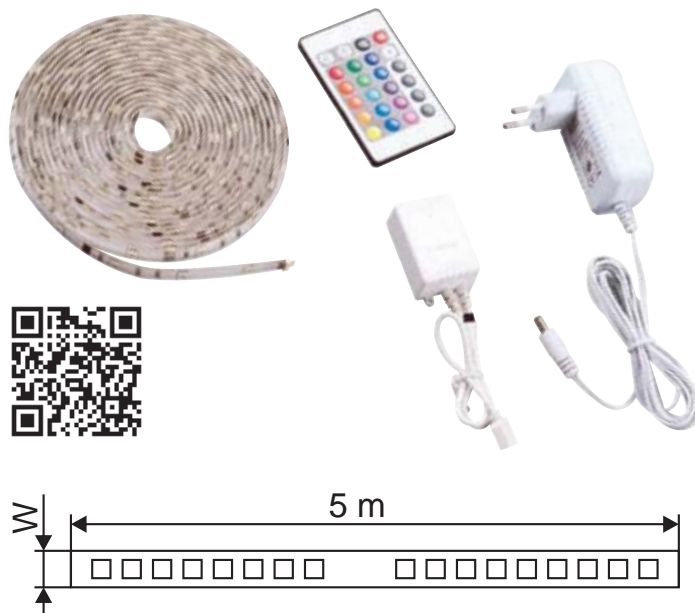

Controlere LED, miniaturale

		IP 20	12-24 V DC	Legendă pictograme E/0	
TRACON	U_n	I_n	TRACON	U_n	I_n
LED-RF-1	12-24 VDC	12 A	LED-RF-2	12-24 VDC	12 A

Moduri de comandă

Butoane pe carcasa controlerului P-0, reglarea intensității fluxului luminos, jocuri de lumini preprogramate cu viteză reglabilă

Moduri de comandă

Telecomandă cu unde radio P-0, reglarea intensității fluxului luminos, jocuri de lumini preprogramate cu viteză reglabilă



Benziile LED monocrome sunt potrivite pentru vizualizarea diferitelor jocuri de lumini preprogramate cu ajutorul controlerelor **LED-RF**. Controlerul LED trebuie instalat între alimentator și banda LED, în circuitul de 12-24 Vc.c. a alimentatorului, selectat în mod corespunzător. Controlerul **LED-RF-1** se poate comanda cu ajutorul butoanelor care se găsesc pe el. Varianta constructivă **LED-RF-2** poate fi comandată prin intermediul telecomenzii cu unde radio. Datorită tehnologiei bazată pe radiofrecvență unitatea de recepție nu trebuie să fie vizibilă telecomenzii. Cu un controler se poate comanda maxim o bandă LED cu lungimea de 5 m !

Controlere LED RGB



TRACON	U_n			IP..
LED-RFRGB-72W	12-24 VDC	72 W	RGB	IP 20
LED-RFRGB-144W	12-24 VDC	144 W	RGB	IP 20



Benziile LED RGB sunt potrivite pentru prezentarea diferitelor jocuri de lumini preprogramate cu ajutorul controlerelor LED-RF. Controlerul LED trebuie instalat între alimentator și banda LED RGB, în circuitul de 12-24 Vc.c. a alimentatorului, selectat în mod corespunzător. Ca accesoriu al controlerelor este telecomanda cu unde radio cu ajutorul căreia se pot comanda LED-urile RGB. Datorită tehnologiei bazată pe radiofrecvență unitatea de recepție nu trebuie să fie vizibilă telecomenzii. Cu un controler se poate comanda maxim o bandă LED cu lungimea de 5 m !

Alimentatoare pentru LED-uri

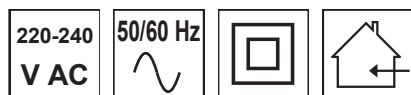

TRACON		IP..	I_n	LxWxH
LED-CV-20W	20 W	IP 20	1,3 A	163x41x14,7 mm
LED-CV-30W	30 W	IP 20	2,5 A	223x40,5x18,2 mm
LED-CV-50W	50 W	IP 20	4,2 A	120x50x33 mm
LED-CV65-50W	50 W	IP 65	2,5 A	178x70x43 mm
LED-CV65-100W	100 W	IP 65	2 x 4,2 A	198x70x43 mm

LED-CV65-..











Pentru funcționarea corespunzătoare, la tensiunea nominală de 12 V, a surselor de lumină cu LED este necesară de o sursă de alimentare de 230 / 12 V potrivită pentru fiecare tip. Alegerea surselor de alimentare potrivite pentru diferitele tipuri se face cu ajutorul tabelului de mai sus.



Profiluri din Aluminiu pentru benzi cu LED-uri



TRACON							
LEDSZSLIM	8 mm	1 m	VLSLIM	LEDZBSLO			
LEDSZTRIO	10 mm	1 m	VLTRIO	LEDZBCTO; LEDZBCTT			
LEDZSURFACE	10 mm	1 m	VLSURFACE	LEDZBCTO; LEDZBCTT			
LEDZCORNER	10 mm	1 m	VLCORNER	LEDZBCTO; LEDZBCTT			



Pentru funcționarea optimă a benzilor cu LED-uri și pentru asigurarea unei durate mari de viață recomandăm utilizarea profilurilor LED din aluminiu. Cu ajutorul profilurilor este asigurată nu numai răcirea, dar și aspectul este mai estetic, mai bine adaptate mediului lor. Produsele au gradul de protecție IP 20, prin urmare benzile cu LED-uri de interior montate în ele nu le fac potrivite pentru utilizarea în exterior! Produsul este disponibil în bare de un metru. Pentru a facilita tăierea, în partea inferioară a profilului nu se găsesc găuri, iar în timpul instalării acestea trebuie găurite de către utilizator în funcție de locația specifică. Benzile LED trebuie plasate în partea de jos a profilului, dispersorul de acoperire se poate glisa în partea interioară a profilului.

Accesorii pentru benzi cu LED

TRACON	Modul de conectare	Caracteristici
LSZT8	Conectarea fără lipire a benzilor LED monocrome	Pentru benzi cu lățimea de 8 mm
LSZT10	Conectarea fără lipire a benzilor LED monocrome	Pentru benzi cu lățimea de 10 mm
LSZTC8	Conectarea fără lipire a benzilor LED monocrome cu conductor de prelungire	Pentru benzi cu lățimea de 8 mm, cu conductor de 15 cm
LSZTC10	Conectarea fără lipire a benzilor LED monocrome cu conductor de prelungire	Pentru benzi cu lățimea de 10 mm, cu conductor de 15 cm
LSZTRGB	Conectarea fără lipire a benzilor LED RGB	Pentru benzi RGB
LSZTCRGB	Conectarea fără lipire a benzilor LED RGB cu conductor de prelungire	Pentru benzi RGB, cu conductor de 15 cm
LSZJF55	Element de conectare între benzile LED monocrome și alimentator	Conector mamă de 5,5 mm/ terminal cu șurub
LSZJM55	Element de conectare între benzile LED monocrome și alimentator	Conector tată de 5,5 mm/ terminal cu șurub

Pentru instalarea mai simplă a benzilor cu LED-uri sunt disponibili de asemenea și diverși conectori suplimentari.

Cu ajutorul lor benzile se pot interconecta fără lipire, respectiv benzile se pot conecta la alimentatoare.



Cosmetizăm sursele noastre de lumină !

– În sfârșit o noutate mondială pe piața din România!



Dezvoltarea continuă a tehnologiei a scos de pe piață sursele de lumină incandescente tradiționale cu consum mare și lămpile fluorescente compacte au preluat rolul surselor de lumină în căminele noastre. Datorită încălzirii lente și a construcției nu prea atrăgătoare mulți utilizatori au regretat vechile becuri incandescente care au fost considerate bune. Prin dezvoltarea rapidă a tehnologiei LED s-au deschis însă noi perspective în tehnica iluminatului.

Sursele LED anterioare datorită dimensiunilor mari, a luminii direcționate și a prețului ridicat au fost capabile să înlocuiască becurile vechi doar în puține gospodării. O tehnologie nouă „cosmetizează” cu pricepere însă aceste dezavantaje.

Modulele LED produc de asemenea căldură, de aceea sursa de lumină LED necesită suprafață mare de răcire, cu aceasta crescând dimensiunea exterioară a produsului și se reduce unghiul de iluminare. O idee nouă ajută la eliminarea acestor dezavantaje: răcirea cu ulei. Această noutate mondială este prezentată de **TRACON ELECTRIC**.

Dacă modulul LED se plasează într-o baie de ulei, atunci transferul de căldură către mediul exterior devine optim, pe lângă reducerea dimensiunilor fizice. Astfel dimensiunile sursei de lumină sunt ajustate la predecesorii cu incandescență tradiționali, pe lângă un consum de energie mult mai redus. Uleiul difuzează lumina astfel spațiul iluminat devine mai mare, combinația între ulei și dispersorul mat asigură o lumină frumoasă uniformă. Uleiul este utilizat de asemenea și în industria cosmetică, nu este un material periculos. Montat în dispersor din material plastic aproape incasabil am obținut o familie utilă de surse de lumină.

Aceasta este familia de produse **FITLamp+** în care se pot găsi surse de lumină în formă de sferă (LOA45) și lumânare (LOC).

Căutați-ne! Merită!

Tracon Electric, specialistul iluminatului cu LED – ro.traconelectric.com
Informații suplimentare la distribuitori și în magazinul nostru virtual !

Sursă de lumină LED, răcire cu ulei

230 V AC 50/60Hz ON-OFF >25.000 SMD LED Hg 0 mg



TRACON							D x L	
LOCE143WW	E14	3 W	30 W	300 lm	3.000 K	360°	35 x 95 mm	A+
LOCE143NW	E14	3 W	30 W	300 lm	4.500 K	360°	35 x 95 mm	A+
LOCE144WW	E14	4 W	40 W	400 lm	3.000 K	360°	35 x 95 mm	A+
LOCE144NW	E14	4 W	40 W	400 lm	4.500 K	360°	35 x 95 mm	A+
LOGE144WW	E14	4 W	40 W	400 lm	3.000 K	360°	38 x 80 mm	A+
LOGE144NW	E14	4 W	40 W	400 lm	4.500 K	360°	38 x 80 mm	A+
LOA45E276WW	E27	6 W	50 W	550 lm	3.000 K	360°	45 x 90 mm	A+
LOA45E276NW	E27	6 W	50 W	550 lm	4.500 K	360°	45 x 90 mm	A+
LOA45E278WW	E27	8 W	60 W	700 lm	3.000 K	360°	55 x 90 mm	A+
LOA45E278NW	E27	8 W	60 W	700 lm	4.500 K	360°	55 x 90 mm	A+
LOA55E2710WW	E27	10 W	75 W	900 lm	3.000 K	360°	55 x 90 mm	A+
LOA55E2710NW	E27	10 W	75 W	900 lm	4.500 K	360°	55 x 90 mm	A+



LOGE14..

Răcirea LED-urilor este asigurată de un ulei cosmetic special, care are proprietăți optime pentru această sarcină:

- Conductivitate termică excelentă
- Nu este coroziv
- Ecologic
- Nu este inflamabil



LOA55..

LOCE14..

CU TEHNOLOGIE DE SUDURĂ LASER!



LOA45..

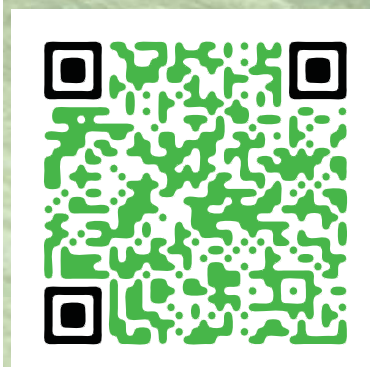
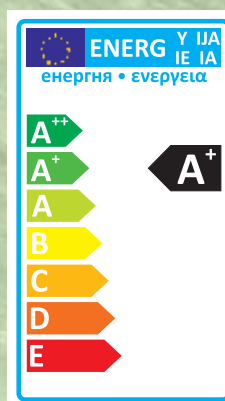
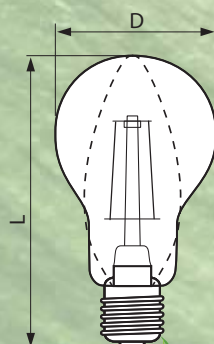

Surse de lumină COG LED

230 V AC	50/60 Hz		≥80	20.000 [h]	ON-OFF >20.000	COG LED	Hg 0 mg	T _{up} < 1s	360°	Legendă pictograme	E/0
-------------	----------	--	-----	------------	-------------------	------------	------------	----------------------	------	---------------------------	------------

TRACON		[W]	LED	[lm]	T _c [K]	[°]	D × L	
COGP452W	E14	2 W	25 W	200 lm	3.000 K	360°	45 × 73 mm	P45 A+
COGC372W	E14	2 W	25 W	200 lm	3.000 K	360°	37 × 100 mm	C37 A+
COGA604W	E27	4 W	40 W	400 lm	3.000 K	360°	60 × 107 mm	A60 A+
COGA606W	E27	6 W	60 W	600 lm	3.000 K	360°	60 × 107 mm	A60 A+



Tehnologia COG

Mulțumită dispunerii cipului LED pe o lamelă specială din sticlă, aceste surse de lumină oferă un iluminat eficient energetic în formă asemănătoare lămpilor tradiționale cu incandescență.

La LED-ul COG (**Chip On Glass**) cipurile sunt dispuse pe o suprafață suport dintr-un material de tip sticlă, astfel se pot realiza tije de iluminat care pot radia lumina aproape în unghi solid maxim. Pot fi create astfel surse de lumină care pot radia lumina chiar și în unghi solid maxim.



COGP452W

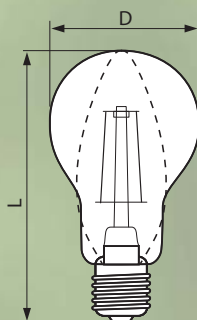

COGC372W

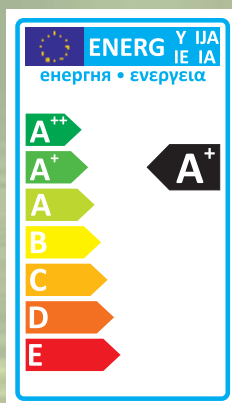



TRACON
COGA606W
230V, 50-60Hz, 6W
2700K, 600lm, 45mA

COGA604W
COGA606W

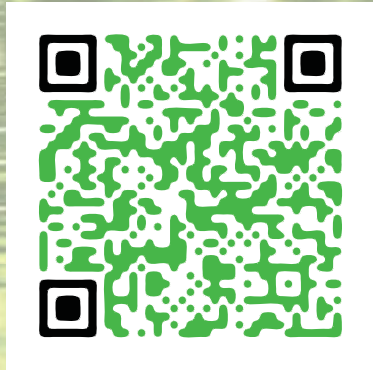

Surse de lumină LED cu formă de pară și sferică

Legendă pictograme
E/O

TRACON							D x L	
LMG453W	E14	3 W	20 W	220 lm	2.700 K	250°	45 x 70 mm	A+
LMG455W	E14	5 W	40 W	370 lm	2.700 K	250°	45 x 78 mm	A+
LMG455NW	E14	5 W	40 W	380 lm	4.000 K	250°	45 x 78 mm	A+
LG454W	E27	4 W	20 W	250 lm	2.700 K	250°	45 x 70 mm	A+
LG455W	E27	5 W	40 W	350 lm	2.700 K	250°	45 x 70 mm	A+
LG455NW	E27	5 W	40 W	350 lm	4.500 K	250°	45 x 70 mm	A+
LA555W	E27	5 W	40 W	400 lm	2.700 K	250°	50 x 92 mm	A+
LA608W	E27	8 W	60 W	520 lm	2.700 K	250°	60 x 110 mm	A+
LA608NW	E27	8 W	60 W	560 lm	4.000 K	250°	60 x 110 mm	A+
LA609W	E27	9 W	60 W	720 lm	2.700 K	250°	60 x 110 mm	A+
LA6511W	E27	11 W	65 W	880 lm	2.700 K	250°	65 x 125 mm	A+
LA6511NW	E27	11 W	65 W	900 lm	4.000 K	250°	65 x 125 mm	A+
LA6512W	E27	12 W	70 W	960 lm	2.700 K	200°	65 x 125 mm	A+
LA6015W	E27	15 W	75 W	1.055 lm	2.700 K	300°	60 x 110 mm	A
LA8012W	E27	12 W	75 W	900 lm	2.700 K	200°	95 x 128 mm	A

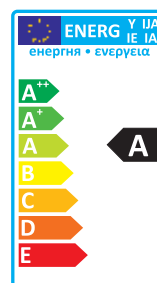
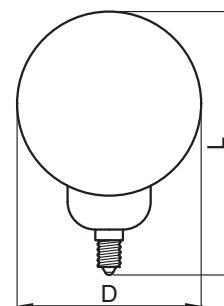

Sursă de lumină LED cu formă de lumânare

230 V AC	50/60 Hz				ON-OFF >30.000	SMD LED	Hg 0 mg			Legendă pictograme	E/0
-------------	----------	--	--	--	-------------------	------------	------------	--	--	---------------------------	------------

TRACON							D × L	
LGYT5W	E14	5 W	40 W	370 lm	2.700 K	250°	38 × 106 mm	A+
LGY5W	E14	5 W	40 W	370 lm	2.700 K	250°	38 × 106 mm	A+



Surse de lumină LED cu formă de reflector

230 V AC	50/60 Hz				ON-OFF >30.000	SMD LED	Hg 0 mg			Legendă pictograme	E/0
-------------	----------	--	--	--	-------------------	------------	------------	--	--	---------------------------	------------

TRACON							D × L	
LR506W	E14	6 W	40 W	350 lm	2.700 K	100°	50 × 84 mm	A+
LR638W	E27	8 W	60 W	510 lm	2.700 K	100°	63 × 101 mm	A+



Surse de lumină Power Spot LED

230 V AC	12 V AC/DC	50/60 Hz		≥80	30.000 [h]	>15.000	SMD LED	Hg 0 mg	T _{up} <1s	40°
-------------	---------------	----------	--	-----	------------	---------	------------	------------	---------------------	-----

TRACON		U _n				T _c [K]		D × L	
LMR165WW	MR16/G5.3	12 V AC/DC	5 W	35 W	300 lm	2.700 K	40°	50 × 47 mm	A+
LMR165CW	MR16/ G5.3		5 W	35 W	330 lm	6.500 K	40°	50 × 47 mm	A+
LMR167WW	MR16/G5.3		7 W	50 W	450 lm	2.700 K	40°	50 × 49 mm	A+
LMR167CW	MR16/G5.3		7 W	50 W	500 lm	6.500 K	40°	50 × 49 mm	A+
LGU105WW	GU10	230 V AC	5 W	35 W	300 lm	2.700 K	40°	50 × 50 mm	A+
LGU105NW	GU10		5 W	35 W	315 lm	4.000 K	40°	50 × 50 mm	A+
LGU105CW	GU10		5 W	35 W	330 lm	6.500 K	40°	50 × 50 mm	A+
LGU107WW	GU10		7 W	50 W	450 lm	2.700 K	40°	50 × 55 mm	A+
LGU107NW	GU10		7 W	50 W	475 lm	4.000 K	40°	50 × 55 mm	A+
LGU107CW	GU10		7 W	50 W	500 lm	6.500 K	40°	50 × 55 mm	A+
LE145WW	E14		5 W	35 W	300 lm	2.700 K	40°	50 × 74 mm	A+
LE145CW	E14	5 W	35 W	330 lm	6.500 K	40°	50 × 74 mm	A+	
LE147WW	E14	7 W	50 W	450 lm	2.700 K	40°	50 × 74 mm	A+	
LE147CW	E14	7 W	50 W	480 lm	6.500 K	40°	50 × 74 mm	A+	
LE275WW	E27	5 W	35 W	300 lm	2.700 K	40°	50 × 64 mm	A+	
LE275CW	E27	5 W	35 W	330 lm	6.500 K	40°	50 × 64 mm	A+	
LE277WW	E27	7 W	50 W	450 lm	2.700 K	40°	50 × 64 mm	A+	
LE277CW	E27	7 W	50 W	480 lm	6.500 K	40°	50 × 64 mm	A+	



LE27..



LMR16

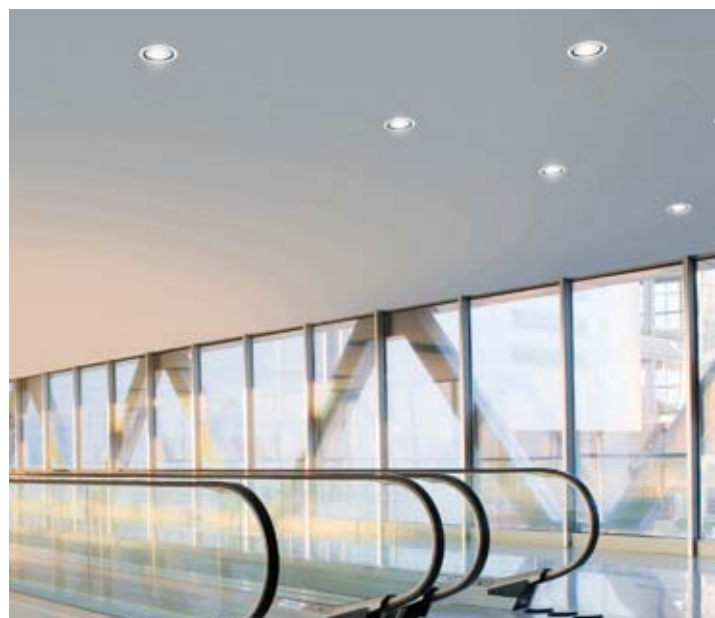
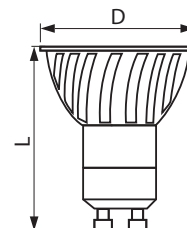
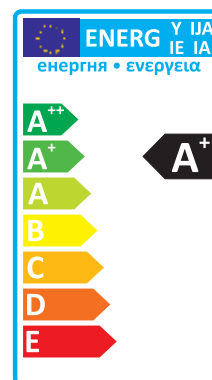

Sursă SMD, spot (15 × LED)

230 V AC	12 V AC/DC	50/60 Hz				ON-OFF >15.000	SMD LED	Hg 0 mg		Legendă pictograme	E/0
-------------	---------------	----------	--	--	--	-------------------	------------	------------	--	-------------------------------	------------

TRACON		U _n				T _c [K]	[°]	D × L	
SMD-E14-15-WW	E14	230 V AC	4 W	35 W	300 lm	3.000 K	120°	50 × 74 mm	A+
SMD-E14-15-CW	E14		4 W	35 W	320 lm	6.400 K	120°	50 × 74 mm	A+
SMD-E27-15-WW	E27		4 W	35 W	300 lm	3.000 K	120°	50 × 72 mm	A+
SMD-E27-15-CW	E27		4 W	35 W	320 lm	6.400 K	120°	50 × 72 mm	A+
SMD-GU10-15-WW	GU10		4 W	35 W	300 lm	3.000 K	120°	50 × 55 mm	A+
SMD-GU10-15-CW	GU10		4 W	35 W	320 lm	6.400 K	120°	50 × 55 mm	A+
SMD-GU10-15-NW	GU10		4 W	35 W	310 lm	4.000 K	120°	50 × 55 mm	A+
SMD-MR16-15-WW	MR16/G5.3	12 V AC	4 W	35 W	300 lm	3.000 K	120°	50 × 45 mm	A+
SMD-MR16-15-CW	MR16/G5.3	AC/DC	4 W	35 W	320 lm	6.400 K	120°	50 × 45 mm	A+

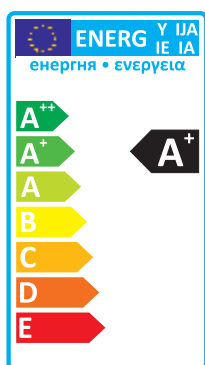
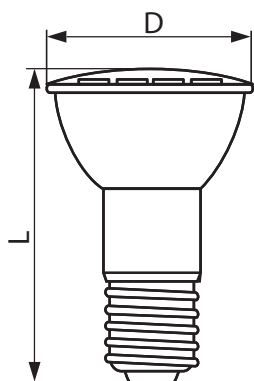

SMD-MR16-15...



SMD-GU10-15...

Sursă SMD, spot (12 × LED)

230 V AC	12 V AC/DC	50/60 Hz				ON-OFF >15.000	SMD LED	Hg 0 mg	
-------------	---------------	----------	--	--	--	-------------------	------------	------------	--

TRACON		U _n				T _c [K]	[°]	D × L	
SMD-E14-12-WW	E14	230 V AC	3 W	20 W	210 lm	3.000 K	120°	50 × 74 mm	A+
SMD-E14-12-CW	E14		3 W	20 W	235 lm	6.400 K	120°	50 × 74 mm	A+
SMD-E27-12-WW	E27		3 W	20 W	210 lm	3.000 K	120°	50 × 72 mm	A+
SMD-E27-12-CW	E27		3 W	20 W	235 lm	6.400 K	120°	50 × 72 mm	A+
SMD-GU10-12-WW	GU10		3 W	20 W	210 lm	3.000 K	120°	50 × 55 mm	A+
SMD-GU10-12-CW	GU10		3 W	20 W	235 lm	6.400 K	120°	50 × 55 mm	A+
SMD-GU10-12-NW	GU10		3 W	20 W	210 lm	4.000 K	120°	50 × 55 mm	A+
SMD-MR16-12-WW	MR16/G5.3	12 V AC	3 W	20 W	210 lm	3.000 K	120°	50 × 45 mm	A+
SMD-MR16-12-CW	MR16/G5.3	AC/DC	3 W	20 W	235 lm	6.400 K	120°	50 × 45 mm	A+

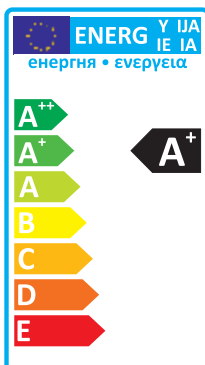
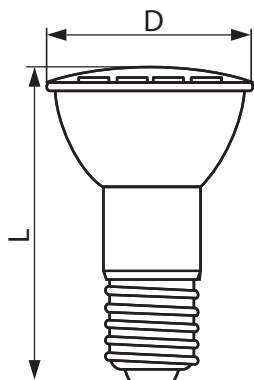

SMD-E14-12...



SMD-E27-12...

Surse de lumină COB LED

230 V AC	50/60 Hz		$Ra \geq 80$	30.000 [h]	ON-OFF >30.000	COB LED	Hg 0 mg			Legendă pictograme	E/0
-------------	----------	--	--------------	------------	-------------------	------------	------------	--	--	---------------------------	------------

TRACON					T_c [K]	$[\circ]$	D x L	
COBGU105WW	GU10	5 W	35 W	350 lm	2.700 K	40°	50 x 53 mm	A+
COBGU105CW	GU10	5 W	35 W	365 lm	6.500 K	40°	50 x 53 mm	A+
COBGU107WW	GU10	7 W	50 W	490 lm	2.700 K	40°	50 x 53 mm	A+
COBGU107CW	GU10	7 W	50 W	511 lm	6.500 K	40°	50 x 53 mm	A+



Surse de lumină COB LED care pot fi comandate prin variatoare de flux luminos

230 V AC	50/60 Hz		$Ra \geq 80$	30.000 [h]	ON-OFF >30.000	COB LED	Hg 0 mg				
-------------	----------	--	--------------	------------	-------------------	------------	------------	--	--	--	--

TRACON					T_c [K]	$[\circ]$	D x L	
COBDGU105WW	GU10	5 W	35 W	350 lm	2.700 K	40°	50 x 53 mm	A+
COBDGU105CW	GU10	5 W	35 W	365 lm	6.500 K	40°	50 x 53 mm	A+

Parametrii tehnici ai surselor de lumină LED care pot fi comandate prin variatoare de flux luminos coincid cu a celor care nu pot fi comandate prin variatoare de flux luminos, dar fluxul luminos poate fi modificat chiar și de variatoare clasice de flux luminos în intervalul 10 – 100 %



Tehnologia COB

Dezvoltarea tehnologiei LED a transpus o etapă în tehnica iluminatului general: apariția COB LED-urilor.

LED-ul COB diferă de LED-ul SMD tradițional prin faptul că cipurile sunt dispuse direct pe suprafața suport metalică, (**Chip On Board**) unul lângă celălalt, astfel o răcire bună și fluxul luminos uniform a încântat utilizatorii cu o durată mai lungă de viață și surse de lumină cu efect luminos mai plăcut.

Surse de lumină industriale cu LED

230 V AC	50/60 Hz		$Ra \geq 80$	[h] 30.000	ON-OFF >15.000	SMD LED	Hg 0 mg	50% Tup < 1s	360°	Legendă pictograme	E/0
-------------	----------	--	--------------	---------------	-------------------	------------	------------	-----------------	------	---------------------------	------------

TRACON				[lm]	Tc [K]	[°]	D x L	
LHPE2720NW	E27	20 W	150 W	1.600 lm	4.000 K	360°	70 x 142 mm	A
LHPE2725NW	E27	25 W	200 W	2.000 lm	4.000 K	360°	70 x 178 mm	A
LHPE4050NW	E40	50 W	350 W	4.000 lm	4.000 K	360°	105 x 250 mm	A

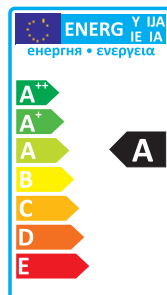
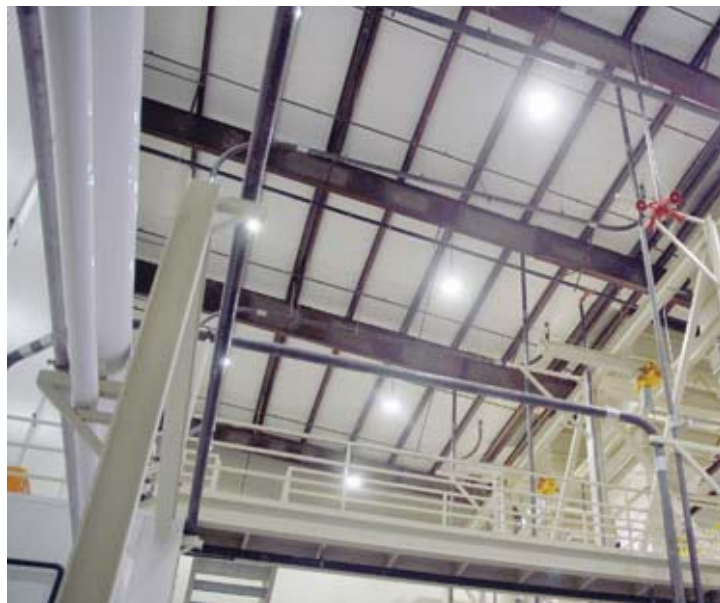

Surse de lumină LED cu soclu R7s

230 V AC	50/60 Hz		$Ra \geq 80$	[h] 30.000	ON-OFF >30.000	SMD LED	Hg 0 mg	50% Tup < 1s	Legendă pictograme	E/0
-------------	----------	--	--------------	---------------	-------------------	------------	------------	-----------------	---------------------------	------------

TRACON				[lm]	Tc [K]	[°]	D x L	
LR7S785NW	R7s	5 W	40 W	350 lm	4.100 K	140°	78x54x35	A+
LR7S1188NW	R7s	8 W	70 W	750 lm	4.100 K	140°	118x54x35	A+
LR7S18914NW	R7s	14 W	100 W	1.050 lm	4.100 K	140°	189x54x35	A+

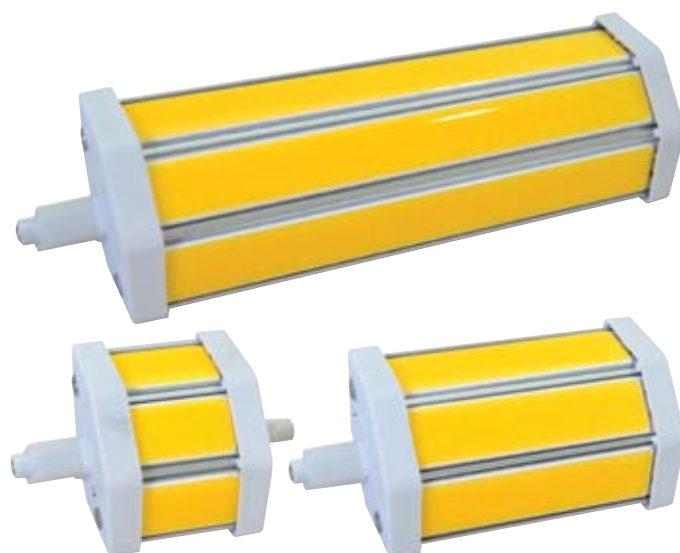
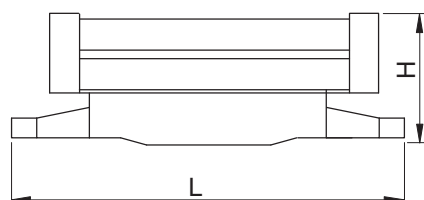
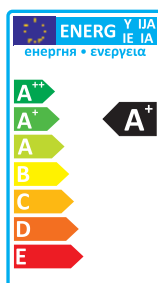

Surse de lumină LED cu soclu G9

230 V AC 50/60 Hz ON-OFF >30.000 SMD LED Hg 0 mg

Legendă pictograme **E/0**

TRACON					Tc [K]		D x L	
LG92W	G9	2,5 W	10 W	120 lm	2.700 K	230°	16 x 42 mm	A+
LG92NW	G9	2,5 W	10 W	120 lm	4.000 K	230°	16 x 42 mm	A+
LG93W	G9	3 W	15 W	200 lm	2.700 K	160°	18 x 55 mm	A+
LG9S3W	G9	3 W	15 W	180 lm	2.700 K	360°	14 x 51 mm	A+
LG9S3NW	G9	3 W	15 W	180 lm	4.000 K	360°	14 x 51 mm	A+
LG94W	G9	4 W	25 W	320 lm	2.700 K	270°	32 x 70 mm	A+
LG9S4W	G9	4 W	25 W	300 lm	2.700 K	360°	16 x 50 mm	A+
LG9S4NW	G9	4 W	25 W	300 lm	4.000 K	360°	16 x 50 mm	A+

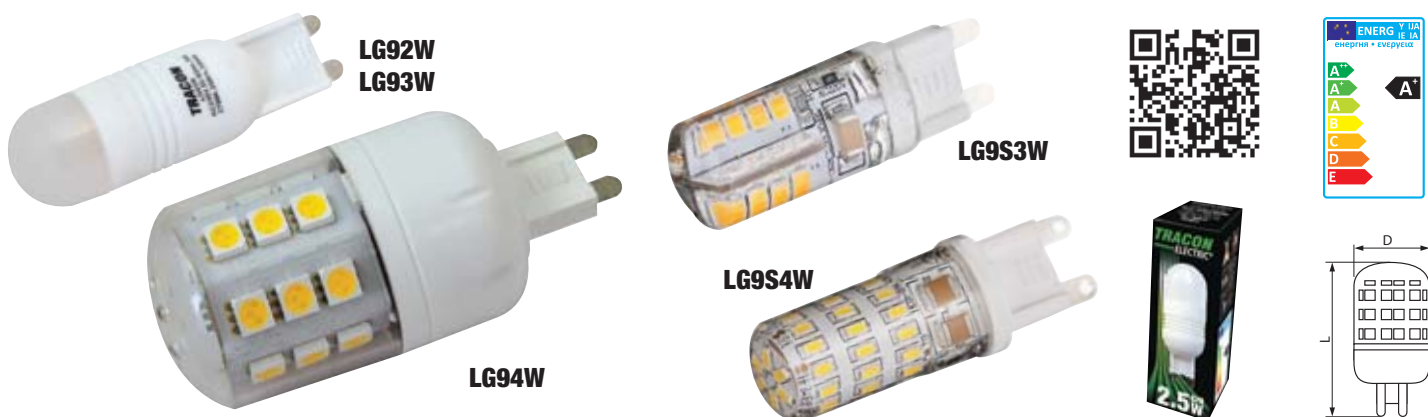

Surse de lumină LED cu soclu G4

230 V AC 50/60 Hz ON-OFF >30.000 SMD LED Hg 0 mg

Legendă pictograme **E/0**

TRACON					Tc [K]		D x L	
LG41,5W	G4	1,5 W	5 W	100 lm	2.700 K	360°	10 x 35 mm	A+
LG41,5NW	G4	1,5 W	5 W	100 lm	4.000 K	360°	10 x 35 mm	A+
LG42W	G4	2,2 W	10 W	180 lm	2.700 K	360°	16 x 42 mm	A+
LG42NW	G4	2,2 W	10 W	180 lm	4.000 K	360°	16 x 42 mm	A+
LG4K2W	G4	2 W	10 W	140 lm	2.700 K	180°	20 x 32 mm	A+
LG4K2NW	G4	2 W	10 W	140 lm	4.000 K	180°	20 x 32 mm	A+

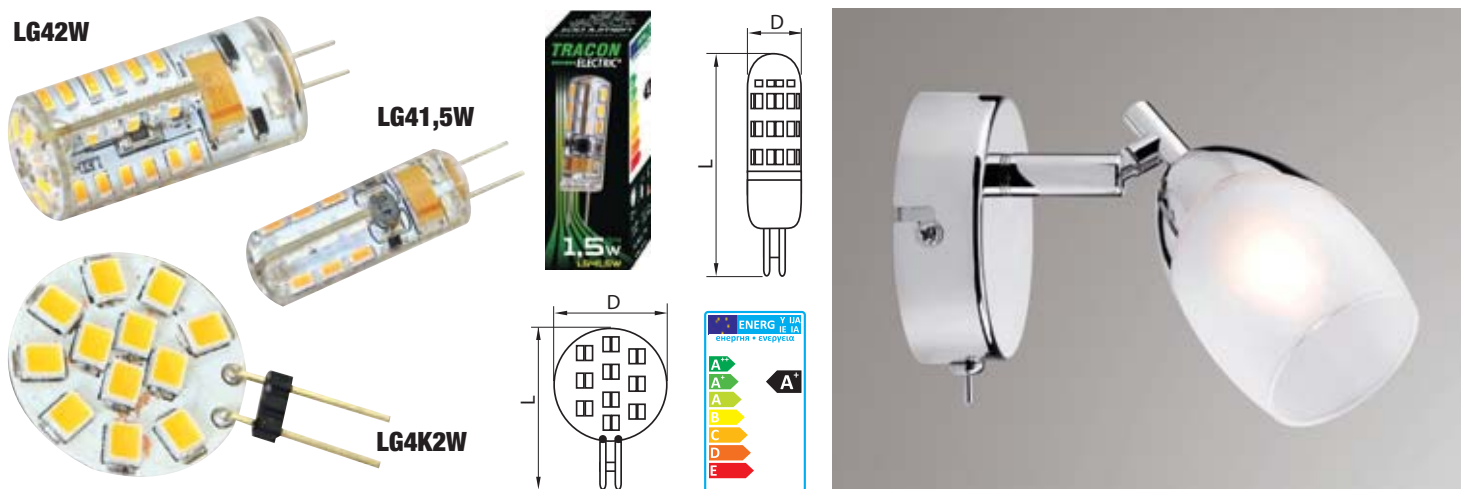

Tuburi luminoase cu LED



TRACON							
LED-T8-06-10-WW	10 W	18 W	900 lm	600 mm	3.000 K	75 × SMD3022	A+
LED-T8-06-10-NW	10 W	18 W	1.000 lm	600 mm	4.000 K	75 × SMD3022	A+
LED-T8-06-10-CW	10 W	18 W	950 lm	600 mm	6.200 K	75 × SMD3022	A+
LED-T8-12-22-WW	22 W	36 W	1.850 lm	1.200 mm	3.000 K	165 × SMD3022	A+
LED-T8-12-22-NW	22 W	36 W	1.900 lm	1.200 mm	4.000 K	165 × SMD3022	A+
LED-T8-12-22-CW	22 W	36 W	2.000 lm	1.200 mm	6.200 K	165 × SMD3022	A+
LED-T8-15-25-WW	25 W	58 W	2.100 lm	1.500 mm	3.000 K	195 × SMD3022	A+
LED-T8-15-25-NW	25 W	58 W	2.200 lm	1.500 mm	4.000 K	195 × SMD3022	A+
LED-T8-15-25-CW	25 W	58 W	2.300 lm	1.500 mm	6.200 K	195 × SMD3022	A+
LED-T8-15-30-WW	30 W	58 W	2.800 lm	1.500 mm	3.000 K	225 × SMD3022	A+
LED-T8-15-30-NW	30 W	58 W	2.900 lm	1.500 mm	4.000 K	225 × SMD3022	A+
LED-T8-15-30-CW	30 W	58 W	3.000 lm	1.500 mm	6.200 K	225 × SMD3022	A+
LED-T8R-06-9NW	9 W	18 W	850 lm	600 mm	4.100 K	75 × SMD2835	A+
LED-T8R-12-18NW	18 W	36 W	1.600 lm	1.200 mm	4.100 K	150 × SMD2835	A+
LED-T8R-15-24NW	22 W	58 W	2.100 lm	1.500 mm	4.100 K	180 × SMD2835	A+

Tuburile luminoase echipate cu tehnică LED pot fi utilizate pentru înlocuirea tuburilor fluorescente tradiționale fără modificarea corpurilor de iluminat. Tuburile luminoase se pot instala în corpurile de iluminat echipate cu balast electronic fără alte componente suplimentare (balastul electronic trebuie eliminat din circuit iar tubul trebuie alimentat direct pe partea marcată).

La corpurile de iluminat cu balast electromagnetic în locul starterului se montează o componentă specială tip punte, care se livrează împreună cu tubul.

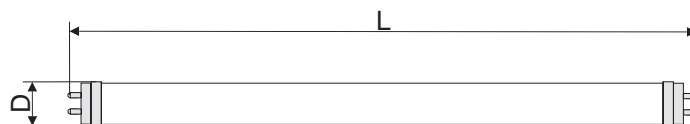

În multe magazine de iluminat specializate au avut loc conversații între vânzător și cumpărător conform celor de mai jos!

– Am cumpărat de la dumneavoastră un bec economic de 11 W dar, **LUMINEAZĂ SLAB!**



– Cumpărați unul de 18 W, cu siguranță dă lumină mai multă.
– Bine, dă lumină suficientă, dar atârână din corpul de iluminat și provoacă efectul de orbire



– Cumpărați atunci alt corp de iluminat sau un bec cu altă formă.
NU AM ALTE IDEI!

FitLamp® rezolvă aceste probleme!

Are aceleași dimensiuni cu ale unui bec incandescent de 75 W

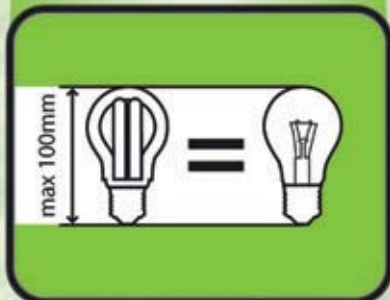

Luminează cât un bec incandescent de 75 W !



Veți îndrăgi FitLamp pentru că este frumos și modern!



**Cod Tracon:
FL18**

TEHNOLOGIE

**Tub compact cu balast electronic
FLUXUL LUMINOS**

1070 lumen

PUTEREA NOMINALĂ

18 W

LUNGIMEA

99 mm

TEMPERATURA DE CULOARE

2700 K (lumină caldă)

TENSIUNEA NOMINALĂ

230 V (50 Hz)

DURATA MEDIE DE VIAȚĂ

6000 h

INDICELE DE REDARE A

CULORII (Ra)

82

ECONOMIA DE ENERGIE

80%

SOCLU

E27

www.fitlamp.ro

Un suport de prezentare
conține
24 de bucăți FitLamp®!
Contactați agenții noștri !



World-wide
NEW
premiere

save
80%
energy

W FITLAMP®

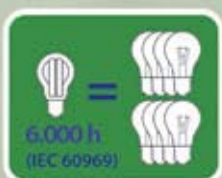

Comparația performanțelor luminotehnice:

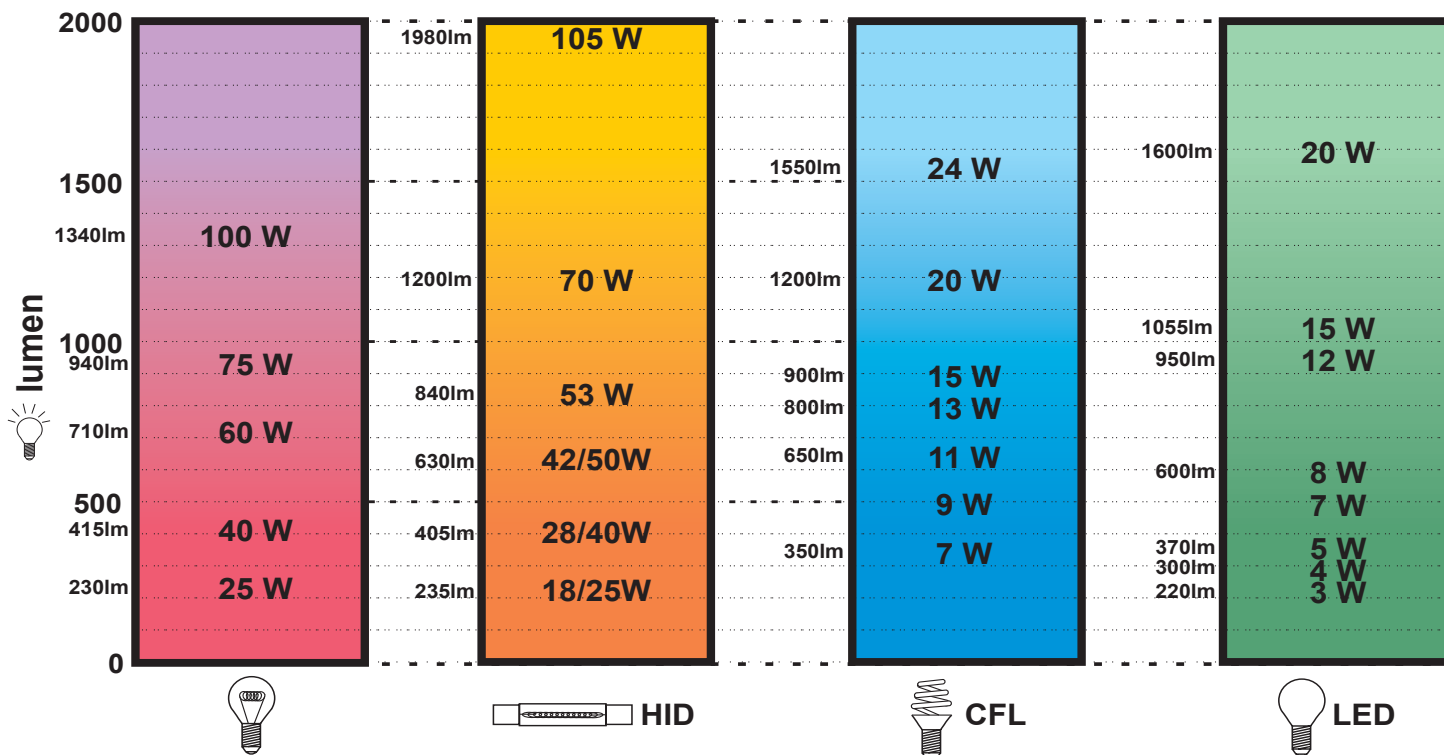

Legendă
 Eticheta: lămpile fluorescente compacte sunt în clasa "A" de eficiență energetică
 $t_{up} < 60s$; 60%lm: timpul de încălzire al sursei de lumină până la atingerea a 60 % din valoarea fluxului luminos total
 Ra: indicele de redare a culorii (100: lumina naturală)
 ON-OFF: numărul ciclurilor de cuplare până la defectarea prematură
 Hg: conținutul de mercur a lămpii
 cosφ: factorul de putere a lămpi

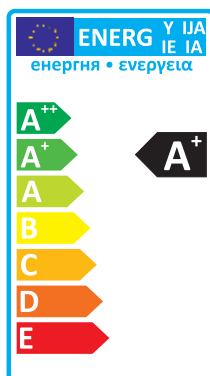

$t_{up} < 60s$
 Ra > 82
 ON - OFF > 10.000
 Hg < 2,5 mg
 cosφ > 0,55
 60% Lm
 L = 112 mm
 W = 36 mm



Forma tubului fluorescent compact TRALUX®

2U	Forma tubului 2U	→	E27, G24q, G24d
3U	Forma tubului 3U	→	E27
4U	Forma tubului 4U	→	E27
GY	Forma lumânare	→	E14
MH	Cilindru miniatură	→	E14
RS	Spirală scurtă	→	E27
MS	Spirală miniatură	→	E14, E27, GU10, G9
KS	Spirală mică	→	E14, E27
GL	Sferă	→	E14, E27
GLH	Pară	→	E14, E27
3U, 4U	Forma tubului 3U, 4U	→	R7s
2D	Covrig	→	GR10q

Socurile lămpilor fluorescente compacte TRALUX®



Lămpi fluorescente compacte, 2U, 3U, 4U



TRACON					In			D (mm)	L (mm)	
TLKF-2U-E27-11W	E27	11 W	638 lm	2.700 K	80 mA	6000 h	>8000	45	156	A
TLKF-2U-E27-14W	E27	14 W	812 lm	2.700 K	100 mA	6000 h	>8000	45	156	A
TLKF-3U-E27-9W	E27	9 W	550 lm	2.700 K	65 mA	8000 h	>10000	40	111	A
TLKF-3U-E27-11W	E27	11 W	650 lm	2.700 K	80 mA	8000 h	>10000	40	121	A
TLKF-3U-E27-13W	E27	13 W	800 lm	2.700 K	95 mA	8000 h	>10000	40	131	A
TLKF-3U-E27-15W	E27	15 W	880 lm	2.700 K	105 mA	8000 h	>10000	40	141	A
TLKF-4U-E27-9W	E27	9 W	550 lm	2.700 K	65 mA	8000 h	>10000	48	100	A
TLKF-4U-E27-11W	E27	11 W	650 lm	2.700 K	80 mA	8000 h	>10000	48	105	A
TLKF-4U-E27-15W	E27	15 W	880 lm	2.700 K	105 mA	8000 h	>10000	48	115	A
TLKF-4U-E27-20W	E27	20 W	1100 lm	2.700 K	150 mA	8000 h	>10000	48	125	A

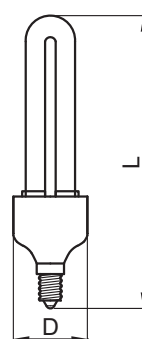
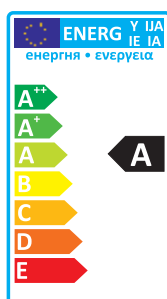

Lămpă fluorescentă compactă de putere, 4U



TRACON					In			D (mm)	L (mm)	
TLKF-HPN-E27-35W	E27	35 W	2250 lm	4.000 K	170 mA	6000 h	>8000	66	227	A

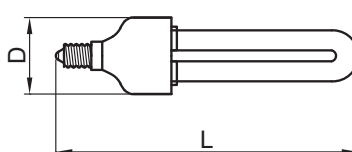

CITIȚI CODUL!

- Vezi noutățile noastre
- Fiți informat

Gama de produse se dezvoltă continuu și rapid!
 Catalogul nostru reflectă situația din Mai 2015.
 Pentru informații actualizate vizitați pagina
 noastră de internet!

Lămpi fluorescente compacte, spirală scurtă

230 V AC 50/60 Hz Hg < 2,5 mg

Legendă pictograme E/O

TRACON					In			D (mm)	L (mm)	
TLKF-RS-E27-15W	E27	15 W	900 lm	2.700 K	105 mA	8000 h	>8000	45	112	A
TLKF-RS-E27-20W	E27	20 W	1200 lm	2.700 K	150 mA	8000 h	>8000	55	115	A
TLKF-RS-E27-24W	E27	24 W	1550 lm	2.700 K	180 mA	8000 h	>8000	55	125	A
TLKF-RSN-E27-15W	E27	15 W	900 lm	4.000 K	105 mA	8000 h	>8000	45	112	A
TLKF-RSN-E27-20W	E27	20 W	1200 lm	4.000 K	150 mA	8000 h	>8000	55	115	A
TLKF-RSN-E27-24W	E27	24 W	1550 lm	4.000 K	180 mA	8000 h	>8000	55	125	A

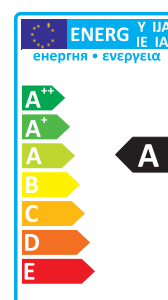
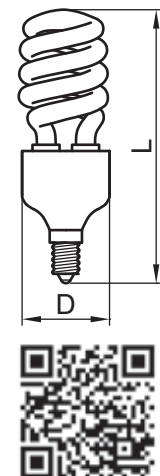

Lămpi fluorescente compacte, lumânare(GY)

230 V AC 50/60 Hz Hg < 2,5 mg

Legendă pictograme E/O

TRACON					In			D (mm)	L (mm)	
TLKF-GY-E14-9W	E14	9 W	440 lm	2.700 K	65 mA	8000 h	>10000	37	112	A

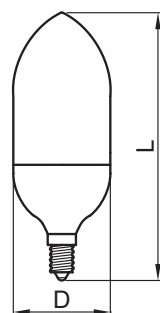

Sursă de lumină LED cu formă de lumânare



E/49

Lămpi fluorescente compacte, minspirală

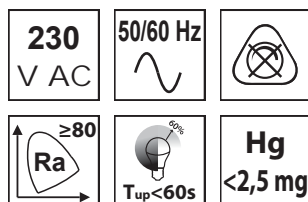

TRACON					I_n			D (mm)	L (mm)	
TLKF-MS-E14-7W	E14	7 W	320 lm	2.700 K	50 mA	8000 h	>10000	32	90	A
TLKF-MS-E14-9W	E14	9 W	450 lm	2.700 K	65 mA	8000 h	>10000	32	95	A
TLKF-MS-E14-11W	E14	11 W	550 lm	2.700 K	80 mA	8000 h	>10000	36	105	A
TLKF-MS-E14-15W	E14	15 W	800 lm	2.700 K	105 mA	8000 h	>10000	36	112	A
TLKF-MS-E27-7W	E27	7 W	320 lm	2.700 K	50 mA	8000 h	>10000	32	90	A
TLKF-MS-E27-9W	E27	9 W	450 lm	2.700 K	65 mA	8000 h	>10000	32	95	A
TLKF-MS-E27-11W	E27	11 W	550 lm	2.700 K	80 mA	8000 h	>10000	36	105	A
TLKF-MS-E27-15W	E27	15 W	800 lm	2.700 K	105 mA	8000 h	>10000	36	112	A
TLKF-MS-G9-7W	G9	7 W	320 lm	2.700 K	50 mA	8000 h	>10000	32	80	A
TLKF-MS-G9-9W	G9	9 W	450 lm	2.700 K	65 mA	8000 h	>10000	32	90	A
TLKF-MS-G9-11W	G9	11 W	550 lm	2.700 K	80 mA	8000 h	>10000	32	105	A
TLKF-MS-GU10-7W	GU10	7 W	320 lm	2.700 K	50 mA	8000 h	>10000	32	80	A
TLKF-MS-GU10-9W	GU10	9 W	450 lm	2.700 K	65 mA	8000 h	>10000	32	90	A
TLKF-MS-GU10-11W	GU10	11 W	550 lm	2.700 K	80 mA	8000 h	>10000	32	105	A
TLKF-MSN-E14-11W	E14	11 W	550 lm	4.000 K	80 mA	8000 h	>10000	36	105	A
TLKF-MSN-E14-15W	E14	15 W	800 lm	4.000 K	105 mA	8000 h	>10000	36	112	A
TLKF-MSN-GU10-11W	GU10	11 W	550 lm	4.000 K	80 mA	8000 h	>10000	32	105	A

Lămpi fluorescente compacte, spirală mică (KS)



TRACON					I_n			D (mm)	L (mm)	
TLKF-E14-11-KS	E14	11 W	600 lm	2.700 K	80 mA	6000 h	>8000	42	127	A
TLKF-E14-13-KS	E14	13 W	720 lm	2.700 K	95 mA	6000 h	>8000	42	127	A
TLKF-E27-11-KS	E27	11 W	600 lm	2.700 K	80 mA	6000 h	>8000	42	127	A
TLKF-E27-13-KS	E27	13 W	720 lm	2.700 K	95 mA	6000 h	>8000	42	127	A
TLKF-E27-15-KS	E27	15 W	770 lm	2.700 K	105 mA	6000 h	>8000	42	135	A

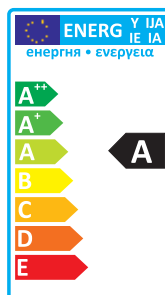
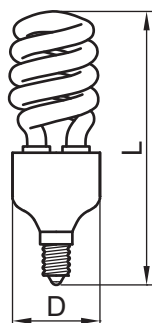

Lămpi fluorescente compacte, sferă (GL), pară (GLH)

Legendă pictograme
E/O

TRACON					I_n			D (mm)	L (mm)	
TLKF-GL-E14-9W	E14	9 W	405 lm	2.700 K	65 mA	8000 h	>8000	60	99	A
TLKF-GL-E27-9W	E27	9 W	405 lm	2.700 K	65 mA	8000 h	>8000	60	96	A
TLKF-GL-E27-15W	E27	15 W	800 lm	2.700 K	105 mA	8000 h	>8000	80	132	A
TLKF-GL-E27-20W	E27	20 W	1155 lm	2.700 K	150 mA	8000 h	>8000	90	144	A
TLKF-GLH-E14-11W	E14	11 W	535 lm	2.700 K	80 mA	8000 h	>8000	50	112	A
TLKF-GLH-E27-11W	E27	11 W	535 lm	2.700 K	80 mA	8000 h	>8000	50	109	A

Lămpi fluorescente compacte GR10q (2D)

Legendă pictograme
E/O

TRACON					I_n			M (mm)	D (mm)	L (mm)	
TLKF-2D-GR10Q-10W	GR10q	10 W	650 lm	3.500 K	65 lm/W	8000 h	>8000	20	14	14	A
TLKF-2D-GR10Q-16W	GR10q	16 W	1056 lm	3.500 K	66 lm/W	8000 h	>8000	20	14,8	14,8	A
TLKF-2D-GR10Q-21W	GR10q	21 W	1344 lm	3.500 K	64 lm/W	8000 h	>8000	20	14,8	14,8	A
TLKF-2D-GR10Q-28W	GR10q	28 W	2044 lm	3.500 K	73 lm/W	8000 h	>8000	20	21,2	21,2	A
TLKF-2D-GR10Q-38W	GR10q	38 W	2698 lm	3.500 K	71 lm/W	8000 h	>8000	20	21,2	21,2	A

Lămpi fluorescente compacte G24d și G24q

230 V AC 50/60 Hz Hg < 2,5 mg

Legendă pictograme **E/O**

TRACON						D (mm)	L ₁ (mm)	L ₂ (mm)	
TLKF-13	G24d	13 W	780 lm	4.000 K	8000 h	33	43	99	A
TLKF-18	G24d	18 W	1.050 lm	4.000 K	8000 h	33	43	114	A
TLKF-26	G24d	26 W	1.550 lm	4.000 K	8000 h	33	43	130	A
TLKF-13-4P	G24q	13 W	780 lm	4.000 K	8000 h	33	36	99	A
TLKF-18-4P	G24q	18 W	1.050 lm	4.000 K	8000 h	33	36	114	A
TLKF-26-4P	G24q	26 W	1.550 lm	4.000 K	8000 h	33	36	130	A

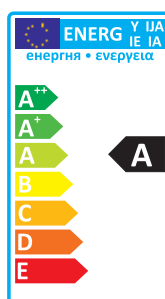
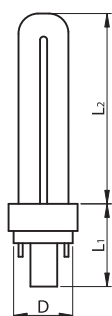

Adaptor R7s cu lampă fluorescentă compactă

230 V AC 50/60 Hz Hg < 2,5 mg

Legendă pictograme **E/O**

TRACON								H (mm)	L (mm)	
TLKF-R7s-4U-11W	R7s	11 W	620 lm	6.500 K	80 mA	8000 h	>8000	30	78	A
TLKF-R7s-21W	R7s	21 W	1250 lm	6.500 K	175 mA	8000 h	>8000	52	118	A

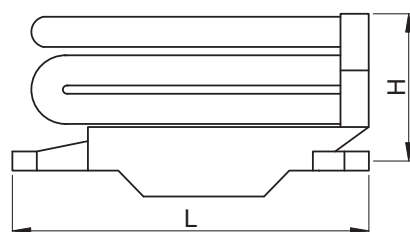
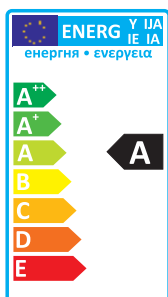

CITIȚI CODUL!

- Vezi noutățile noastre
- Fiți informat

Gama de produse se dezvoltă continuu și rapid!
 Catalogul nostru reflectă situația din Mai 2015.
 Pentru informații actualizate vizitați pagina noastră de internet!

Surse halogen liniare (clasa de energie „C”)



230 V AC 50/60 Hz Hg 0 mg

TRACON		In				Tc [K]		
THV1C-J100	100 W	0,43 A	1.800 lm	2.000 h	>2.000	2.900 K	78 mm	C
THV1C-J120	120 W	0,53 A	2.200 lm	2.000 h	>2.000	2.900 K	78 mm	C
THV2C-J200	200 W	0,87 A	4.000 lm	2.000 h	>2.000	2.900 K	118 mm	C
THV2C-J230	230 W	1 A	4.700 lm	2.000 h	>2.000	2.900 K	118 mm	C
THV2C-J330	330 W	1,43 A	7.000 lm	2.000 h	>2.000	2.900 K	118 mm	C
THV2C-J400	400 W	1,74 A	8.600 lm	2.000 h	>2.000	2.900 K	118 mm	C
THV3C-J750	750 W	3,26 A	16.900 lm	2.000 h	>2.000	2.900 K	189 mm	C

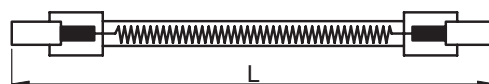

Soclu tip R7s pentru surse halogen liniare

230 V AC 50/60 Hz

Legendă pictograme **E/0**

TRACON		L (mm)	
THF-C	soclu porțelan	-	150 mm
THF-78	soclu 2 buc. + șină	78 mm	150 mm
THF-118	soclu 2 buc. + șină	118 mm	200 mm
THF-189	soclu 2 buc. + șină	189 mm	200 mm

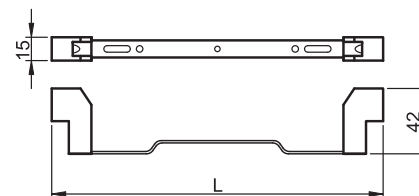
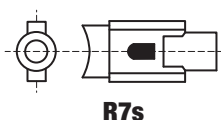

Lămpi incandescente halogen

230 V AC 50/60 Hz Hg 0 mg

Legendă pictograme **E/0**

TRACON					Tc [K]	D (mm)	L (mm)	pcs	
TLWI-G9-60-F	60 W	G9	2.000 h	>2.000	2.700 K	14	40	3	F
TLWI-G9C-18	18 W	G9	2.000 h	>2.000	2.700 K	14	40	1	C
TLWI-G9C-28	28 W	G9	2.000 h	>2.000	2.700 K	14	40	1	C

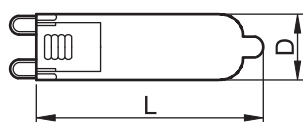

Lămpi cu reflector



TRACON									
		W		[h]		[K]	(mm)	(mm)	
TLRL-R50-E14-25-F	TLRL-R50-E14-25	25 W	E14	1.000 h	>2.000	2.700 K	50	85	F
-	TLRL-R63-E27-40	40 W	E27	1.000 h	>2.000	2.700 K	63	100	F
-	TLRL-R63-E27-60	60 W	E27	1.000 h	>2.000	2.700 K	63	100	F

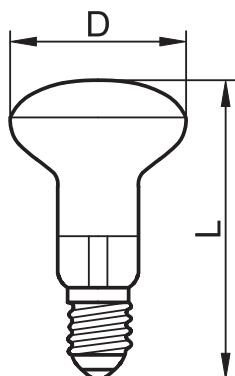

Surse halogen de 12V

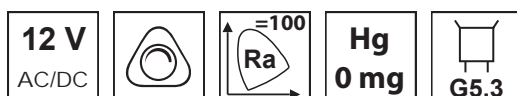

TRACON									
		W		[h]		[K]	[°]		
MR11-20	MR11	20 W	G5.3	2.000 h	>2.000	2.700 K	40°	C	
MR11-35	MR11	35 W	G5.3	2.000 h	>2.000	2.700 K	40°	C	
MR16-20	MR16	20 W	G5.3	2.000 h	>2.000	2.700 K	30°	C	
MR16-35	MR16	35 W	G5.3	2.000 h	>2.000	2.700 K	30°	C	
MR16-50	MR16	50 W	G5.3	2.000 h	>2.000	2.700 K	30°	C	

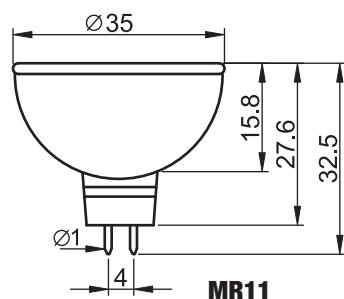

MR11

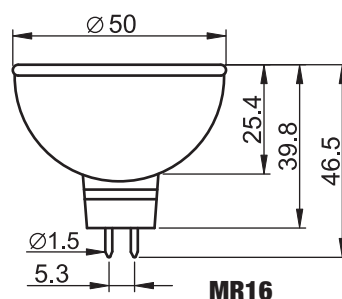

MR16



CITIȚI CODUL!

- Vezi noutățile noastre
- Fiți informat

Gama de produse se dezvoltă continuu și rapid!
 Catalogul nostru reflectă situația din Mai 2015.
 Pentru informații actualizate vizitați pagina
 noastră de internet!

Soclu din material ceramic pentru surse de joasă tensiune



12 V
AC/DC



Legendă
pictograme

E/O

TRACON

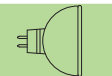

TG-5.5

G5.3

MR11, MR16

100 mm

RELEVANT STANDARD
EN 60061

RELEVANT STANDARD
EN 60838

Soclu E27



250
V AC



Legendă
pictograme

E/O

TRACON



FPE27

E27

2 x 2,5mm²

RELEVANT STANDARD
EN 60238

RELEVANT STANDARD
EN 60061

RELEVANT STANDARD
EN 60838

Dulie material ceramic pentru surse de 230 V



230
V AC



Legendă
pictograme

E/O

TRACON



TGU-10

GU10

100 mm

RELEVANT STANDARD
EN 60061

RELEVANT STANDARD
EN 60838

Surse halogen 230 V dicroice

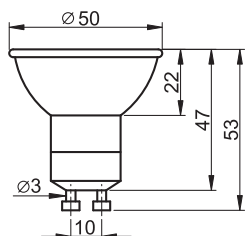

230
V AC



=100
Ra

Hg
0 mg



Legendă
pictograme

E/O

TRACON

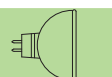

Model	Base	Power [W]	Base	Lifetime [h]	ON-OFF	Tc [K]	Beam angle [°]	Ei
MR230-20	JDR+A	20 W	GU10	2.000 h	>2.000	2.700 K	45°	C
MR230-35	JDR+A	35 W	GU10	2.000 h	>2.000	2.700 K	45°	C
MR230-50	JDR+A	50 W	GU10	2.000 h	>2.000	2.700 K	45°	C



RELEVANT STANDARD
EN 61549

Adaptor rețea pentru surse de lumină MR230

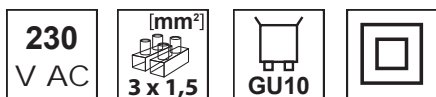

TAGU-10 MR230 50 W

Utilizarea lor deschide posibilitatea folosirii surselor halogen 230V di-croice în corpurile de iluminat aferente.

Conductoarele de alimentare se conectează în bornele de legătură și sunt prinse cu o clemă de fixare.

Cu ajutorul arcurilor adaptorul se poate fixa pe corpul de iluminat.

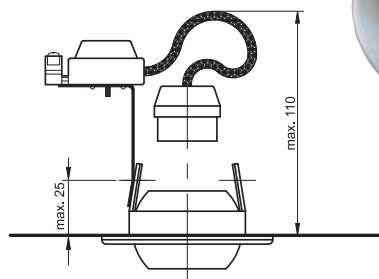

**RELEVANT STANDARD
EN 60061**

Transformatoare electronice

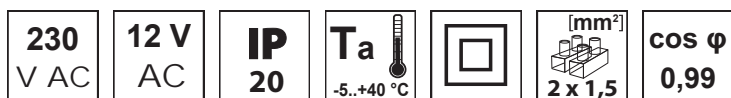

TRACON			L (mm)	W (mm)	H (mm)
MRE-50		20 W ... 60 W	131	33	21
MRE-105		35 W ... 105 W	156	48	36
MRE-150	MR11 / MR16	50 W ... 150 W	220	48	38
MRE-200		70 W ... 200 W	220	48	38
MRE-250		85 W ... 250 W	220	48	38

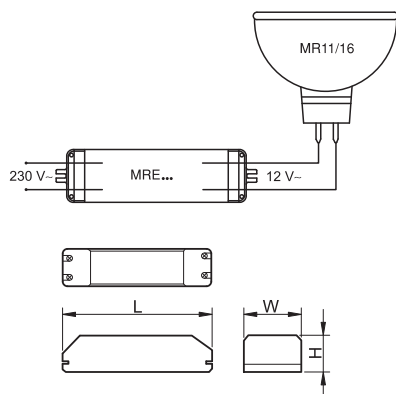

Senzori infraroșii de mișcare, încadrați

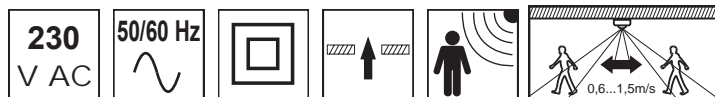

TRACON	[°]	lux	clock	IP..	L H W	document
TMB-060	160°	3-2.000 lux	10s...7 min.	IP 20	80 × 80 × 34	în doza de aparat
TMB-061	360°	3-2.000 lux	10s...7 min.	IP 20	∅ 76 × 75,6	în tavan fals

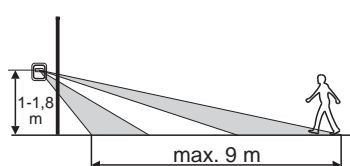

TMB-060



TMB-061

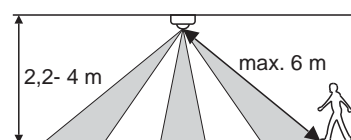

Senzorii de mișcare infraroșii încadrați se recomandă în interior pentru comanda funcționării consumatorilor, unde modalitatea de montare încadrată a senzorilor asigură un aspect mai estetic. Cuplearea senzorilor în funcție de temporizare și de nivelul de iluminare se poate regla continuu, însă trebuie avut grijă, că setarea ulterioară se poate efectua numai cu o nouă demontare a senzorului montat!

Capacitatea de comutație

	TMB-060	TMB-061
Bec cu incandescență	1.000 W	1.100 W
Bec cu halogen	800 W	900 W
Tuburi fluorescente	300 W	300 W
LED	300 W	300 W

Detectoare de mișcare tip radar

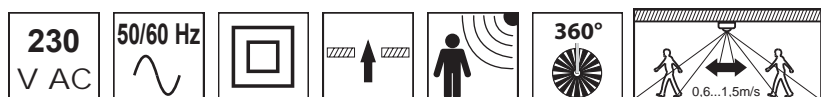

TRACON	[°]	lux	clock	IP..	L H W	document
TMB-L01G	360°	3-2.000 lux	10s...12 min.	IP 20	76,2 × 42 × 43,8 mm	În doză, tavan fals,
TMB-L01D	360°	3-2.000 lux	10s...12 min.	IP 20	58 × 40,5 × 25,5 mm	în corpul de iluminat



TMB-L01G

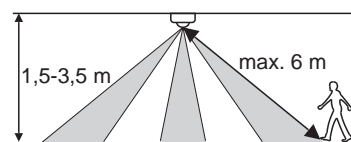

TMB-L01D

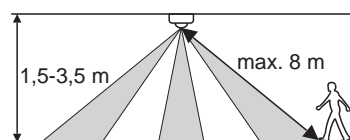

Spre deosebire de senzorii de mișcare în infraroșu, detectoarele de mișcare tip radar detectează mișcarea și prin materiale solide, astfel se pot monta în doze din material plastic, în corpurile de iluminat, în tavane false din ghips-carton și vată minerală. Trebuie să se țină cont însă, că undele radar nu pot penetra suprafețele metalice! Montarea mascată oferă beneficii estetice și de siguranță.

Capacitatea de comutație

	TMB-L01G	TMB-L01D
Bec cu incandescență	1.200 W	500 W
Bec cu halogen	1.000 W	400 W
Tuburi fluorescente	300 W	200 W
LED	300 W	200 W

Senzori de mișcare care se pot monta în soclu E27

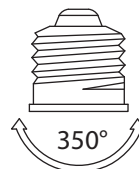
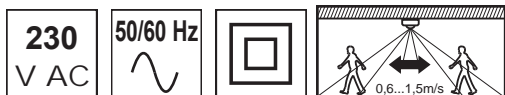

TRACON	[°]	lux	clock	IP..	H L W	document
TMB-E50	120°	3-2.000 lux	10 s...5 min.	IP 20	∅ 64,5 × 127	E27
TMB-ME51	360°	3-2.000 lux	10 s...12 min.	IP 20	71 × 50 × 81,5	E27

Adaptorul trebuie înșurubat simplu în soclu, astfel sursa de lumină montată în soclul detectorului este imediat operațională prin intermediul detectorului de mișcare.

Datorită tehnologiei radar **TMB-ME51** sesizează prin materiale subțiri, deci și prin dispersorul corpului de iluminat. Tipul **TMB-E50** funcționează cu tehnologia infraroșu, de aceea este funcțional doar stând liber.

După montarea sensorului **TMB-E50** în soclul E27, acesta se poate roti 350 de grade, astfel încât fereastra de sesizare poate fi rotită în poziția dorită.



TMB-ME51

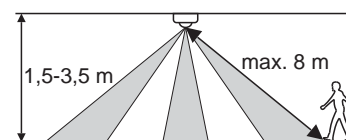

TMB-E50

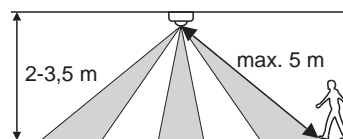

Capacitatea de comutație

	TMB-E50	TMB-ME51
Bec cu incandescentă	60 W	60 W
Bec cu halogen	60 W	60 W
Tuburi fluorescente	30 W	30 W
LED	30 W	30 W

Senzor de mișcare de montat pe tavan

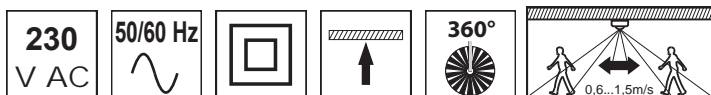

TRACON	[°]	lux	clock	IP..	H L W	document
TMB-011	360°	3-2.000 lux	10s...7 min.	IP 20	∅ 88 × 42	pe tavan

Aparatul se recomandă în primul rând pentru cuplarea automată a iluminatului în spațiile interioare mai mari. Datorită domeniului de sesizare (360°), senzorii montați pe mijlocul tavanului din încăpere pot asigura o zonă de detectare cu raza de 6 m la nivelul pardoselii, pentru un singur senzor.

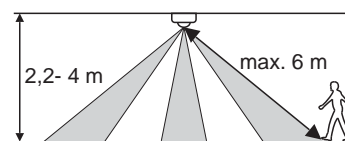

TMB-011

Capacitatea de comutație

	TMB-011
Bec cu incandescentă	1.000 W
Bec cu halogen	800 W
Tuburi fluorescente	300 W
LED	300 W







CITIȚI CODUL!

- Vezi noutățile noastre
- Fiți informat

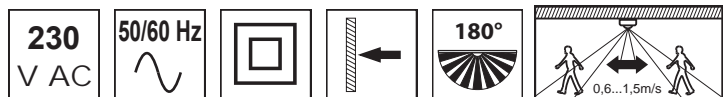
Gama de produse se dezvoltă continuu și rapid!
Catalogul nostru reflectă situația din Mai 2015.
Pentru informații actualizate vizitați pagina noastră de internet!

Detectoare infraroșii de mișcare, cu montare pe perete



TRACON	 [°]	 lux		IP..	L x W x H (mm)	
TMB-108	180°	3-2.000 lux	10s...7 min.	IP 44	82 × 104 × 72	pe perete vertical
TMB-112	180°	3-2.000 lux	10s...7 min.	IP 44	91 × 84 × 63	pe perete vertical
TMB-112F	180°	3-2.000 lux	10s...7 min.	IP 44	91 × 84 × 63	pe perete vertical
TMB-115	180°	3-2.000 lux	10s...7 min.	IP 65	80 × 117 × 51	pe perete vertical

Detectorii de mișcare cu montare pe perete se recomandă în primul rând pentru comanda iluminatului exterior. Senzorul aparatelor fixate pe perete se poate regla atât vertical cât și orizontal într-un interval de aproximativ 120°. La tipul **TMB-115** însă, senzorul se poate regla orizontal 360° iar vertical mai mult de 180°.

Cuplarea detectoarelor în funcție de temporizare și nivelul de iluminare a mediului ambiant, se poate regla continuu.

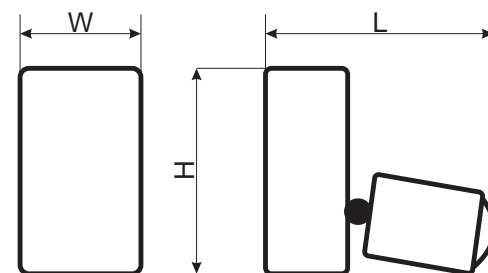

TMB-108



TMB-112



TMB-112F



TMB-115

Capacitatea de comutație

	TMB-108	TMB-112	TMB-112F	TMB-115
Bec cu incandescență	1.000 W	1.000 W	1.000 W	1.000 W
Bec cu halogen	800 W	800 W	800 W	800 W
Tuburi fluorescente	300 W	300 W	300 W	300 W
LED	300 W	300 W	300 W	300 W

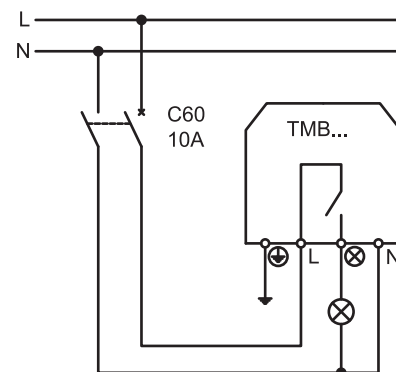
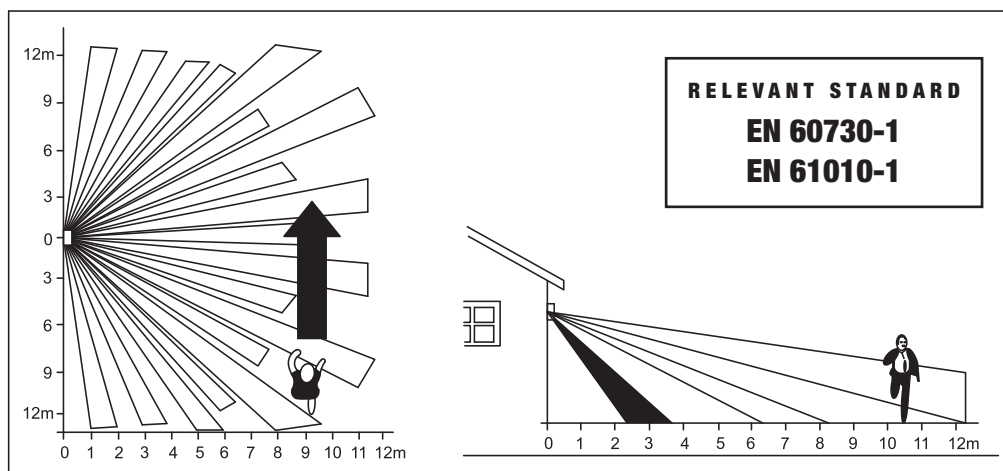
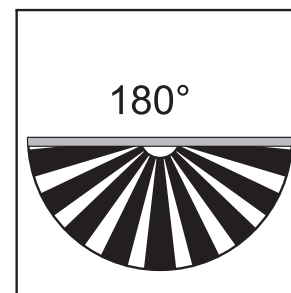

Senzori crepusculari

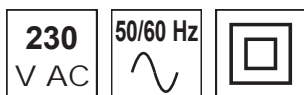

TRACON	I_n	lux			IP..
ALK-IN	5 A	2-200 lux	1-8 h, OFF	1 min.	IP 44
ALK-OUT	10 A	5-50 lux	-	<15 sec	IP 44
ALK-BOX	16 A	2-100 lux	-	<15 sec	IP 20

Familia de senzori crepusculari se pot utiliza la comanda automată a iluminatului unor spații exterioare (grădini, parcuri, gospodării, curți e.t.c.), sau a vitrinelor, respectiv iluminarea reclamelor în funcție de condițiile de luminositățe a mediului în care sunt montați. Dacă nivelul de iluminare scade sub o anumită valoare reglată, senzorul crepuscular va cupla, iar dacă nivelul de iluminare crește peste valoarea reglată, decuplează din nou. **ALK-IN** dispune și de un temporizator care după cuplare, va decupla după o anumită perioadă de timp, indiferent de nivelul de iluminare. Dacă temporizatorul se decuplează (poziția finală) atunci funcționează ca un comutator crepuscular normal.

Capacitatea de comutație

	ALK-IN	ALK-OUT	ALK-BOX
Bec cu incandescentă	300 W	500 W	900 W
Bec cu halogen	200 W	300 W	500 W
Tuburi fluorescente	100 W	120 W	200 W
LED	100 W	120 W	200 W



ALK-IN



ALK-OUT

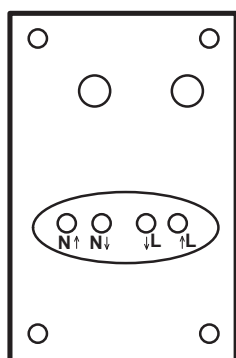

ALK-BOX

**Instalare:**

Pe perete, conductoare sub tencuială

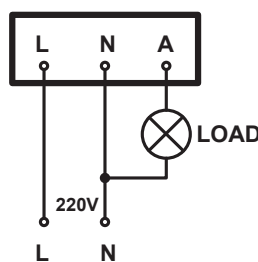
**Instalare:**

Pe perete conductoare pe tencuială

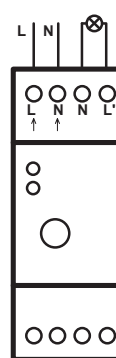
**Instalare:**

În tablou de distribuție cu senzor extern

**CITIȚI CODUL!**

- Vezi noutățile noastre
- Fiți informat

**Gama de produse se dezvoltă continuu și rapid!
Catalogul nostru reflectă situația din Mai 2015.
Pentru informații actualizate vizitați pagina
noastră de internet!**