

Pictogramele capului de tabel

U_m Tensiunea nominală de acționare	U_e Tensiunea nominală de funcționare	I_{th} Curent termic nominal (A)	U_i Tensiunea nominală de izolare
I_e Curent nominal de lucru	I_n Curent nominal (A)	I_{cu} Capacitate nominală de rupere în scurtcircuit în exploatare	I_s Curent consumat
I_m Valoare reglată a declanșorului termic (A)	P_e Putere maximă comutată	P_m Consum propriu	P_s Putere pornire
P_{ON} Consum de putere – cuplare	P_{HOLD} Consum de putere – menținere	Stingere arc electric (mm)	Numărul transformatoarelor de curent
Durata de viață mecanică	Durata de viață electrică:	Contacte	Desfășurarea contactelor
Contacte auxiliare	intrare inferioară-super. de cablu	intrare inferioară de cablu	intrare superioară de cablu
Dimensiuni ax de acționare	Distanța între axe	Secțiune	Numărul de șuruburi
Siguranța din amonte recomandată	Capacitatea electrică	Semnalizator optic	Domeniul de reglaj al temporizării
În carcasă IP65	Dimensiuni (LxWxH)	Secțiunea conductorului de racord	Note, completări
Plin, Lițat, Flexibil	Masa		

Pictogramele datelor tehnice

U_m 230 V AC Tensiunea nominală de acționare	U_e 660 V Tensiunea nominală de funcționare	U_i 690 V Tensiunea nominală de izolare	U_{imp} 6 kV Tensiune nominală de țineră la impuls
U_{test} 1min 1,8 kV Tensiune de încercare	I_{th} 1 A Curent termic nominal (A)	I_e 2 A Curent nominal de lucru	I_{cu} 120 kA _{eff} Capacitate nominală de rupere în scurtcircuit în exploatare
40/60 Hz Frecvența nominală	Class Ir 10A Clasa declanșării termice	UVR Tipul declanșorului: tensiune minimă	SHT Tipul declanșorului: tensiune de lucru
P_m 5 VA Consum propriu	P_{ON} 30 VA Consum de putere – cuplare	P_{HOLD} 4,5 VA Consum de putere – menținere	Siguranța din amonte recomandată
Acționare magnetică	Acționare cu motor	AC 6b Categoriza de utilizare	Rezistență la vibrații
Contacte auxiliare	IP10 Grad de protecție în stare montată: braț de cuplare deschis	IP20 Grad de protecție în stare montată: braț de cuplare închis	IP 65 Grad de protecție
Clasa I de protecție la atingere	ON-OFF-ON... sc/h x4.800 Frecvența de conectare (comutări/oră)	Durata de viață mecanică	Durata de viață electrică:
350 mm Lungime	[mm²] 2x1-2x6 Secțiunea conductorului de racord	Se poate fixa pe șină de montaj	pe plan vertical, deviere admisă ±30°
2000 m Înălțime maximă de utilizare	To -5..+40°C Temperatura de funcționare	Ta -25..+65°C Temperatura mediului ambiant	Umiditate relativă



Întrerupătoare compacte - USOL-uri de tip KM 2



Sisteme de acționare manuală pt. întrerupătoare KM 4



Întrerupătoare compacte modulare tip MKM 6



Întrerupătoare de sarcină de curent continuu 8



Siguranțe fuzibile MPR 9

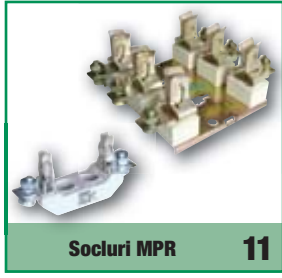

Socuri MPR 11



Cuțite de scurtcircuitare 11



Separator cu siguranțe cilindrice 12



Separatoare orizontale cu siguranțe MPR 14



Separatoare orizontale cu siguranțe MPR, varianta constructivă cu montaj pe bare 15



Separatoare verticale cu siguranțe MPR pentru sisteme de bare cu distanță între axe de 185 mm 16



Sistem de bare COSMO de 60 mm 18



Suporturi de bare și capace aferente (distanța între axe 60 mm) 18



Cleme derivație 18



Cleme tip prismă 19



Întrerupătoare manuale tip TK 20



Carcase 21



Set de garnituri 21



Separatoare 29



Întrerupătoare separatoare de siguranță cu zăvorire prin lacăt 30



Întrerupătoare manuale de curent continuu 33



Contactoare auxiliare 35



Contactoare de uz general 36



TEMS - Combinații de întrerupătoare de protecție pentru motoare, montate în carcasă 38



Contactoare de curenți mari 40



Contacte auxiliare frontale 42



TR8... contact auxiliar lateral 43

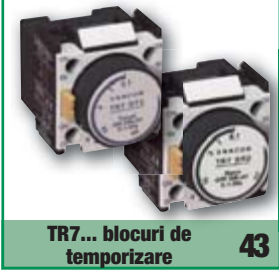

TR7... blocuri de temporizare 43

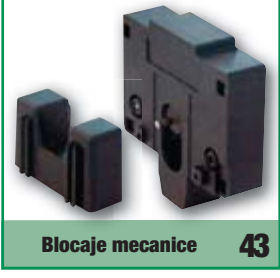

Blocaje mecanice 43



Relee termice de protecție 44



Întrerupătoare pentru protecția motoarelor 48



Contacte auxiliare frontale 50



Declanșator tensiune de lucru 51



Cutii 51

Înteruptoare compacte – USOL-uri de tip KM

230/400 V AC 50/60 Hz U_i 690 V U_{imp} 6 kV 3P T_o -5..+40°C T_a -5..+55°C 2000 m

Legendă pictograme I/O



Datele declanșorului termic

			$I_{th\ max.}$		I_e
KM1		1500	63 A	8500	32 A; 40 A; 50 A; 63 A
KM2		1500	100 A	8500	63 A; 80 A; 100 A
KM3		1000	160 A	7000	125 A; 140 A; 160 A
KM4		1000	225 A	7000	180 A; 200 A; 225 A
KM5		1000	350 A	7000	250 A; 315 A; 350 A
KM6		1000	630 A	4000	400 A; 500 A; 630 A
KM7		1000	800 A	4000	630 A; 700 A; 800 A

Datele declanșorului termic

	$I_{th\ max.}$	I_{cu}	
KM1	63 A	50 kA	0 mm
KM2	100 A	50 kA	0 (<50) mm
KM3	160 A	50 kA	0 (<50) mm
KM4	225 A	50 kA	<50 mm
KM5	350 A	50 kA	<50 mm
KM6	630 A	50 kA	100 mm
KM7	800 A	65 kA	100 mm

Influențele temperaturii mediului asupra curbei caracteristice de decuplare

Pentru obținerea limitei maxime a sarcinii admise pentru perioadă mai îndelungată de timp se utilizează factori de corecția temperaturii mediului de lucru. În situația în care în locul unde este montat întrerupătorul valoarea temperaturii depășește +40 °C, sarcina maximă admisă pe o perioadă mai îndelungată de timp se calculează cu ajutorul factorilor de corecție din tabelul de mai jos.

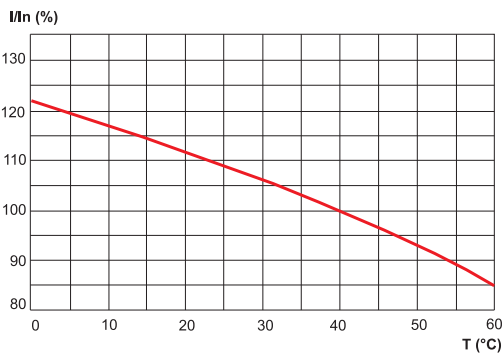

RELEVANT STANDARD
EN 60947-1

RELEVANT STANDARD
EN 60947-2

Factori de corecție

	T_a				
	40 – 45 °C	45 – 50 °C	50 – 55 °C	55 – 60 °C	60 – 65 °C
KM1	1,0	0,94	0,88	0,80	0,72
KM2	1,0	0,95	0,89	0,84	0,76
KM3	1,0	0,97	0,93	0,90	0,86
KM4	1,0	0,96	0,91	0,87	0,82
KM5	1,0	0,94	0,87	0,81	0,73
KM6	1,0	0,93	0,88	0,83	0,76
KM7	1,0	0,88	0,83	0,79	0,76

Curbă caracteristică de decuplare

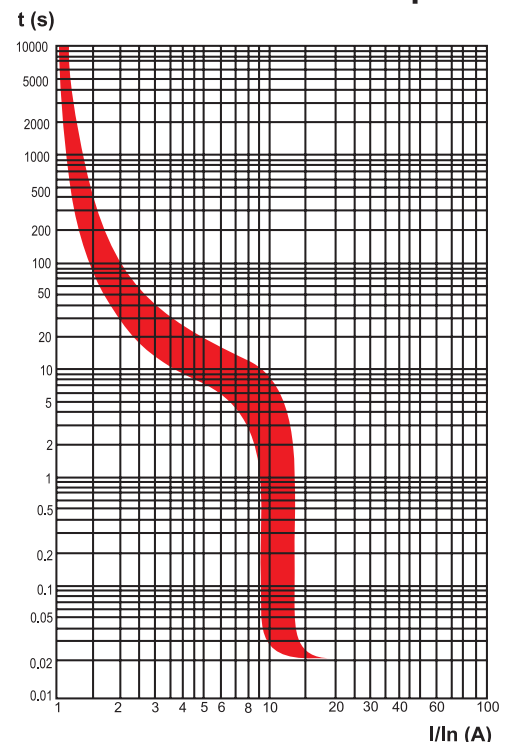

Accesorii ale circuitelor auxiliare

Declanșor de tensiune minimă

U_m	P_m
230 V AC	2,3 – 3,8 VA

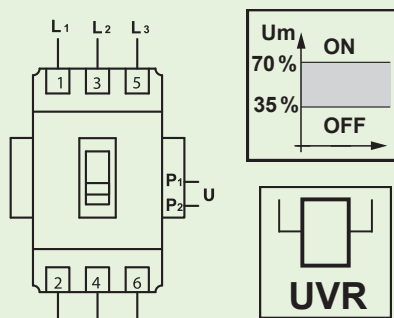

Dacă tensiunea de la bornele declanșorului scade la 35-70% din valoarea tensiunii nominale de acționare declanșorul va acționa întrerupătorul. Declanșorul previne cuplarea întrerupătorului dacă la bornele acestuia valoarea tensiunii nu atinge 35% din valoarea tensiunii nominale de acționare.

Declanșor (șunt) de curent de lucru

U_m
230 V AC, 400 V AC, 220 V, DC

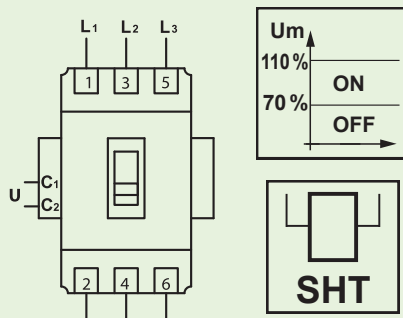

Cu ajutorul acestui declanșor, întrerupătorul se poate acționa de la distanță, deoarece dacă la borne apare 70-110% din tensiunea nominală de acționare, întrerupătorul va decupla.

Contacte auxiliare

U_e	I_e AC-15	U_i	I_{th}
230 V AC	1,2 A	690 V	10 A gG 3 A
400 V AC	0,5 A		

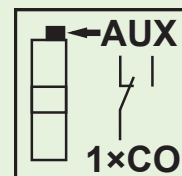

KM1-..
KM2-..
KM3-..
KM4-..

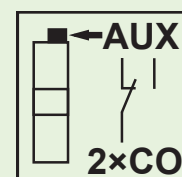

KM5-..
KM6-..
KM7-..

Înteruptoare compacte cu un contact auxiliar

TRACON	I_e		U_m
KM1-032/1A	32 A	SHT	230 V AC
KM1-032/1B	32 A	SHT	400 V AC
KM1-032/1C	32 A	SHT	220 V DC
KM1-032/2	32 A	UVR	230 V AC
KM1-040/1A	40 A	SHT	230 V AC
KM1-040/1B	40 A	SHT	400 V AC
KM1-040/1C	40 A	SHT	220 V DC
KM1-040/2	40 A	UVR	230 V AC
KM1-050/1A	50 A	SHT	230 V AC
KM1-050/1B	50 A	SHT	400 V AC
KM1-050/1C	50 A	SHT	220 V DC
KM1-050/2	50 A	UVR	230 V AC
KM1-063/1A	63 A	SHT	230 V AC
KM1-063/1B	63 A	SHT	400 V AC
KM1-063/1C	63 A	SHT	220 V DC
KM1-063/2	63 A	UVR	230 V AC
KM2-063/1A	63 A	SHT	230 V AC
KM2-063/1B	63 A	SHT	400 V AC
KM2-063/1C	63 A	SHT	220 V DC
KM2-063/2	63 A	UVR	230 V AC
KM2-080/1A	80 A	SHT	230 V AC
KM2-080/1B	80 A	SHT	400 V AC
KM2-080/1C	80 A	SHT	220 V DC
KM2-080/2	80 A	UVR	230 V AC
KM2-100/1A	100 A	SHT	230 V AC
KM2-100/1B	100 A	SHT	400 V AC

TRACON	I_e		U_m
KM2-100/1C	100 A	SHT	220 V DC
KM2-100/2	100 A	UVR	230 V AC
KM3-125/1A	125 A	SHT	230 V AC
KM3-125/1B	125 A	SHT	400 V AC
KM3-125/1C	125 A	SHT	220 V DC
KM3-125/2	125 A	UVR	230 V AC
KM3-140/1A	140 A	SHT	230 V AC
KM3-140/1B	140 A	SHT	400 V AC
KM3-140/1C	140 A	SHT	220 V DC
KM3-140/2	140 A	UVR	230 V AC
KM3-160/1A	160 A	SHT	230 V AC
KM3-160/1B	160 A	SHT	400 V AC
KM3-160/1C	160 A	SHT	220 V DC
KM3-160/2	160 A	UVR	230 V AC
KM4-180/1A	180 A	SHT	230 V AC
KM4-180/1B	180 A	SHT	400 V AC
KM4-180/1C	180 A	SHT	220 V DC
KM4-180/2	180 A	UVR	230 V AC
KM4-200/1A	200 A	SHT	230 V AC
KM4-200/1B	200 A	SHT	400 V AC
KM4-200/1C	200 A	SHT	220 V DC
KM4-200/2	200 A	UVR	230 V AC
KM4-225/1A	225 A	SHT	230 V AC
KM4-225/1B	225 A	SHT	400 V AC
KM4-225/1C	225 A	SHT	220 V DC
KM4-225/2	225 A	UVR	230 V AC

Înteruptoare compacte cu două contacte auxiliare

TRACON	I _e		U _m
KM5-250/1A	250 A	SHT	230 V AC
KM5-250/1B	250 A	SHT	400 V AC
KM5-250/1C	250 A	SHT	220 V DC
KM5-250/2	250 A	UVR	230 V AC
KM5-315/1A	315 A	SHT	230 V AC
KM5-315/1B	315 A	SHT	400 V AC
KM5-315/1C	315 A	SHT	220 V DC
KM5-315/2	315 A	UVR	230 V AC
KM5-350/1A	350 A	SHT	230 V AC
KM5-350/1B	350 A	SHT	400 V AC
KM5-350/1C	350 A	SHT	220 V DC
KM5-350/2	350 A	UVR	230 V AC
KM6-400/1A	400 A	SHT	230 V AC
KM6-400/1B	400 A	SHT	400 V AC
KM6-400/1C	400 A	SHT	220 V DC
KM6-400/2	400 A	UVR	230 V AC
KM6-500/1A	500 A	SHT	230 V AC
KM6-500/1B	500 A	SHT	400 V AC

TRACON	I _e		U _m
KM6-500/1C	500 A	SHT	220 V DC
KM6-500/2	500 A	UVR	230 V AC
KM6-630/1A	630 A	SHT	230 V AC
KM6-630/1B	630 A	SHT	400 V AC
KM6-630/1C	630 A	SHT	220 V DC
KM6-630/2	630 A	UVR	230 V AC
KM7-630/1A	630 A	SHT	230 V AC
KM7-630/1B	630 A	SHT	400 V AC
KM7-630/1C	630 A	SHT	220 V DC
KM7-630/2	630 A	UVR	230 V AC
KM7-700/1A	700 A	SHT	230 V AC
KM7-700/1B	700 A	SHT	400 V AC
KM7-700/1C	700 A	SHT	220 V DC
KM7-700/2	700 A	UVR	230 V AC
KM7-800/1A	800 A	SHT	230 V AC
KM7-800/1B	800 A	SHT	400 V AC
KM7-800/1C	800 A	SHT	220 V DC
KM7-800/2	800 A	UVR	230 V AC

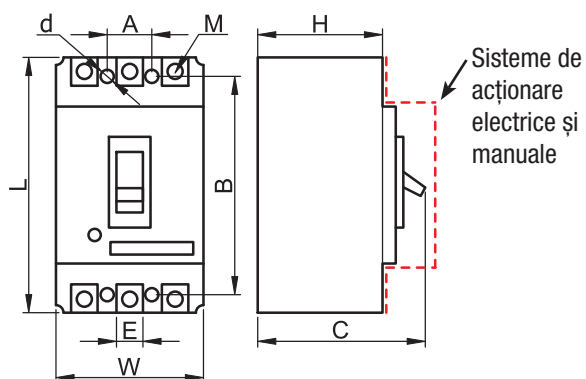

Desen cotelat, găuri de fixare

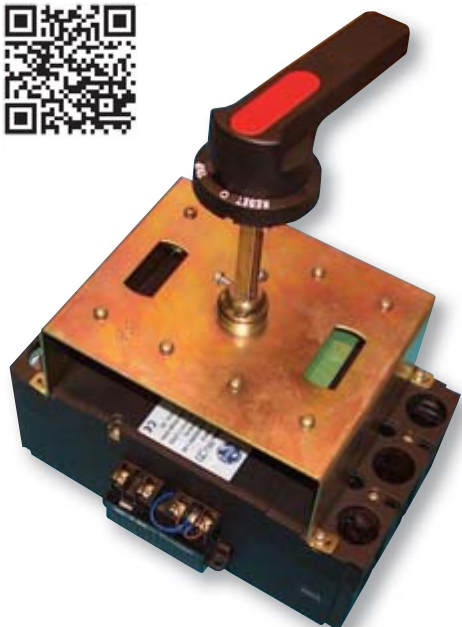

	W (mm)	L (mm)	H (mm)	C (mm)	A (mm)	B (mm)	E (mm)	M (mm)	d (mm)
KM1	78	136	74	98	25	117	13.5	M5	3.5
KM2	92	150	80	104	30	129	18	M8	4.5
KM3	107	165	98	127	35	126	23	M8	5
KM4	107	165	98	127	35	126	23	M8	5
KM5	150	257	98	155	44	194	32	M10	7
KM6	182	270	105	160	58	200	43	M12	7
KM7	210	280	98	142	70	243	43	M12	7

Sisteme de acționare manuală pt. întreruptoare KM



TRACON		A (mm)	B (mm)	H (mm)	
KM1-HM	KM1	102	25	50	8 × 8 / 150 mm
KM2-HM	KM2	104	30	53	8 × 8 / 150 mm
KM4-HM	KM3-KM4	142	35	56	8 × 8 / 150 mm
KM5-HM	KM5	194	138	94	10 × 10 / 150 mm
KM6-HM	KM6	200	168	96	10 × 10 / 150 mm
KM7-HM	KM7	240	195	85	10 × 10 / 150 mm

Sistemele de acționare manuală de tip KM..-HM sunt utilizate pentru comutarea întreruptoarelor, fără a deschide ușa tabloului. Sistemul manual de acționare este compus din elementul de acționare montat pe întreruptor, axul de transmisie și brațul de acționare care indică starea oprită-pornită a întreruptorului. Brațul de acționare se poate bloca în ambele poziții. Când brațul de acționare este în poziția pornită, ușa panoului nu se poate deschide.

Găuri de fixare

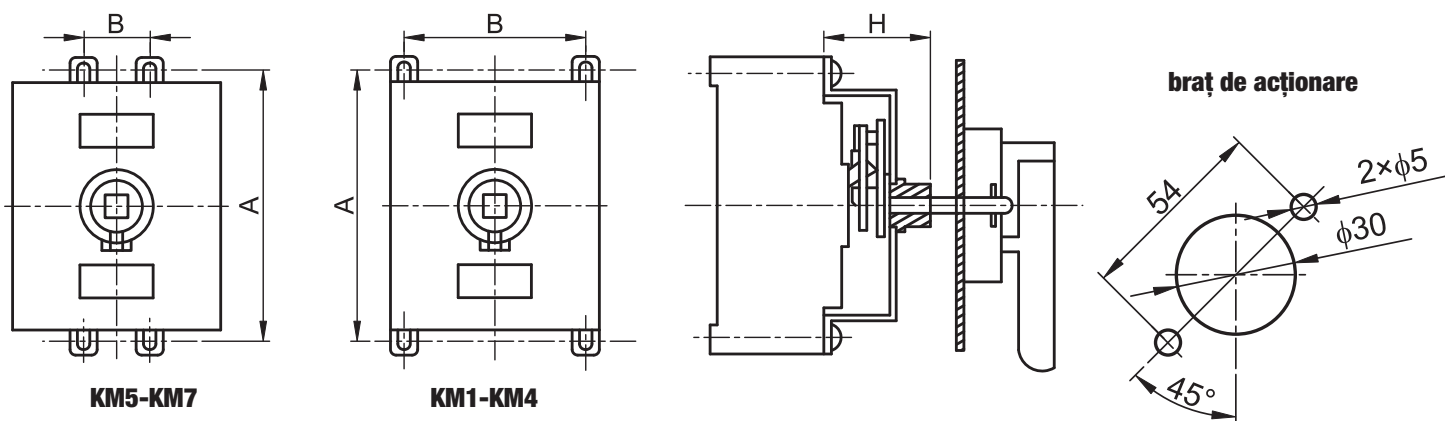

Sisteme electrice de acționare



TRACON			I_s	P_s	A (mm)	B (mm)	H (mm)
KM1-PM		KM1	< 5 A	1100 W	102	25	92
KM2-PM		KM2	< 7 A	1540 W	104	30	92
KM4-PM		KM3-KM4	< 8,5 A	1870 W	142	35	100
KM5-PM		KM5	< 5,7 A	1200 W	194	44	140
KM6-PM		KM6	< 5,7 A	1200 W	200	58	140
KM7-PM		KM7	< 7,5 A	2000 W	240	70	140

Cu ajutorul sistemelor de acționare electrică este posibilă acționarea locală sau de la distanță a înteruptoarelor cu ajutorul unui buton. Sistemul electric de acționare este compus din elementul de acționare montat pe înteruptor, care este prevăzut cu un braț de acționare mecanică. În cazul înteruptoarelor KM1...KM4, acționarea se realizează cu sistem magnetic iar la KM5...KM7, cu motor

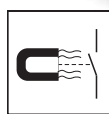
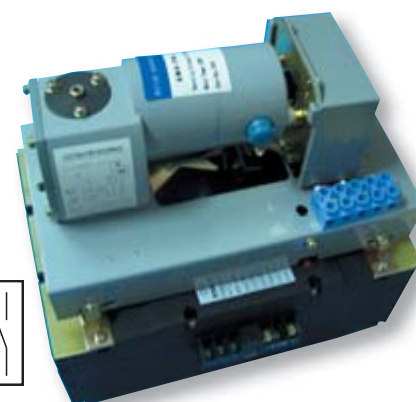

Acționare magnetică

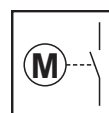

Acționare cu motor

Schemă electrică, desene cotate

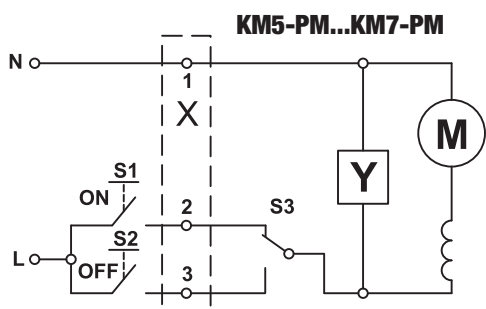
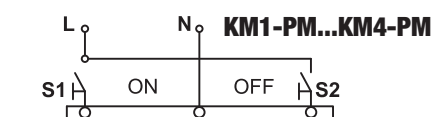

Legendă:

- M - motor;
- Y - frână electrică;
- S3 - microînterupător;;
- X - clemă șir;
- S1,S2 - buton de comandă;

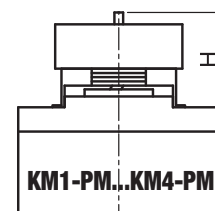
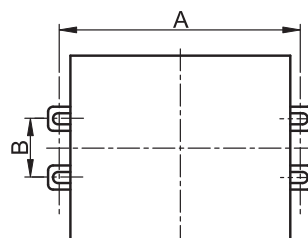

KM1-PM...KM4-PM

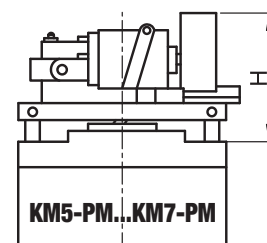

KM5-PM...KM7-PM

Înterupătoare compacte modulare tip MKM

230/400 V AC 50/60 Hz U_i 500 V U_{imp} 6 kV 3P T_o -5..+40°C T_a -25..+65°C 2000 m

Legendă pictograme I/O



	MKM1	MKM2
I_e (A)	15, 20, 25, 30, 40, 50, 60, 75, 80, 100	125, 160, 225, 250
I_{cu} (kA _{eff}) AC	220/240V	50
	380V	30
	400V	20
I_{cs}/I_{cu} (%)	220/240V	25%
	380V	25%
	400V	25%
ON-OFF-ON... sc/h	× 10	× 5
$\times 10^5$	8.500	8.500
$\times 10^5$	4.000	4.000
m	0,78 kg	1,3 kg

TRACON	I_e	TRACON	I_e	TRACON	I_e	TRACON	I_e
MKM1-15	15 A	MKM1-40	40 A	MKM1-80	80 A	MKM2-225	225 A
MKM1-20	20 A	MKM1-50	50 A	MKM1-100	100 A	MKM2-250	250 A
MKM1-25	25 A	MKM1-60	60 A	MKM2-125	125 A		
MKM1-30	30 A	MKM1-75	75 A	MKM2-160	160 A		

Desen cotate (MKM1)

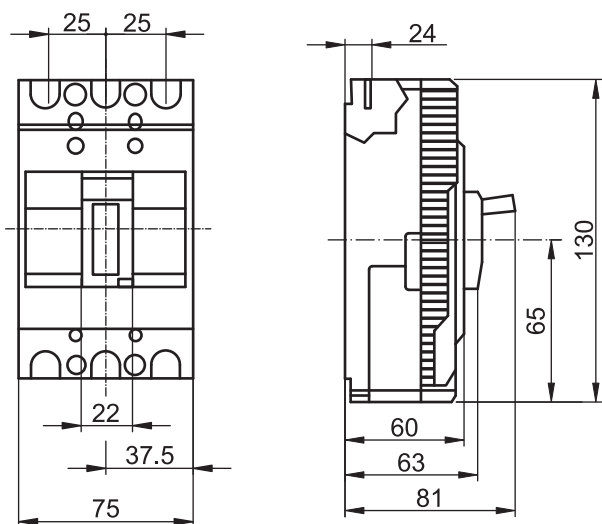

Desen cotate (MKM2)

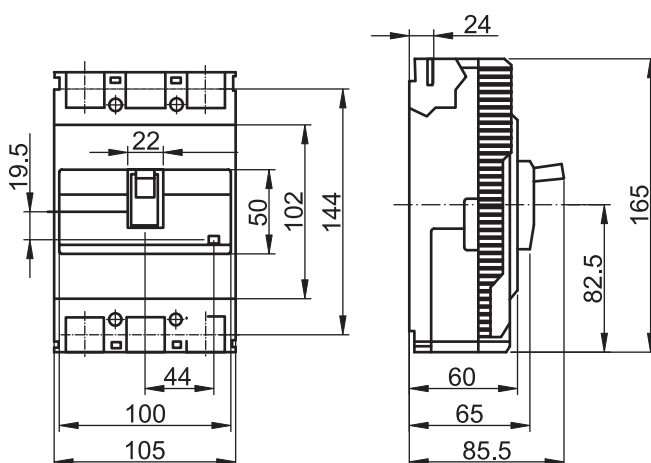

CITIȚI CODUL !

- Vezi noutățile noastre
- Fiți informat

Gama de produse se dezvoltă continuu și rapid!
 Catalogul nostru reflectă situația din Octombrie 2017.
 Pentru informații actualizate vizitați pagina noastră de internet!



Contacte auxiliare și unități de semnalizare defect

Tip	Funcție
Contacte auxiliare:	Oferă informații despre starea contactelor principale a întrerupătorului compact
Contacte de semnalizare defect:	Oferă informații despre declanșarea întrerupătorului modular compact datorită unui scurtcircuit, suprasarcină sau operare.
Contacte de semnalizare defect/ auxiliare:	Cu ajutorul unității cu contacte creată prin combinarea celor două unități de mai sus se pot rezolva și sarcini combinate de comandă.

I_{th} 1 A	AC 15	I_e 0,8 A	 350 mm
------------------------------	-----------------	-------------------------------	---



MKM-AX

TRACON	Denumire		
MKM-AX100	Contact auxiliar	MKM1-..	0,25 mm ²
MKM-AX250	Contact auxiliar	MKM2-..	0,35 mm ²
MKM-AL100	Contact de semnalizare defect	MKM1-..	0,25 mm ²
MKM-AL250	Contact de semnalizare defect	MKM2-..	0,35 mm ²
MKM-AXAL100	Contact semnalizare defect/contact auxiliar	MKM1-..	0,25 mm ²
MKM-AXAL250	Contact semnalizare defect/contact auxiliar	MKM2-..	0,35 mm ²





MKM-AL

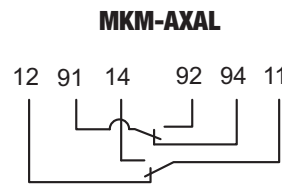
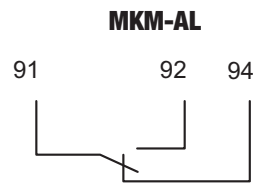
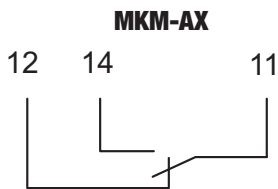

MKM-AXAL



Declanșator tensiune de lucru

TRACON			
MKM-SHT1-230	MKM1-..	<30 VA	0,25 mm ²
MKM-SHT2-230	MKM2-..		0,35 mm ²

Cu ajutorul lui întrerupătorul modular compact se poate comanda de la distanță. SHT1-230 se poate instala în partea dreaptă și stângă a întrerupătoarelor, pe când SHT2-230 se poate instala în partea dreaptă a întrerupătoarelor. Unitatea declanșează deja întrerupătorul de la 0,7 din tensiunea de acționare. Durata tensiunii de acționare este de max. 1 s.

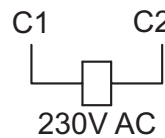

U_m 230 V AC

 350 mm



Găuri de fixare

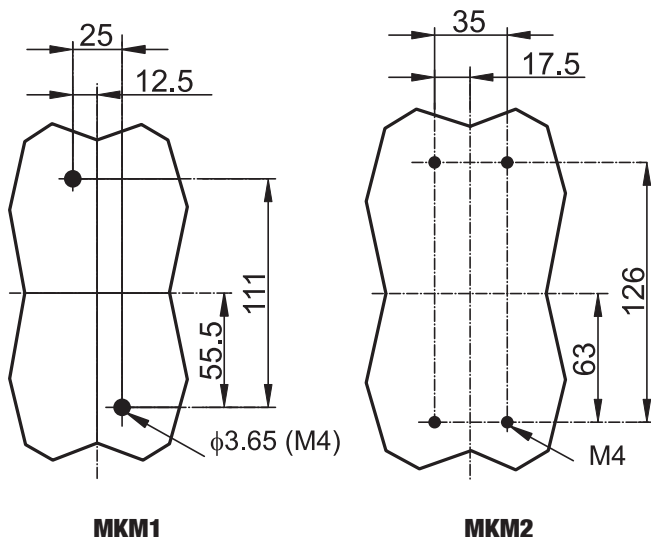

Pozițiile brațului de comutare

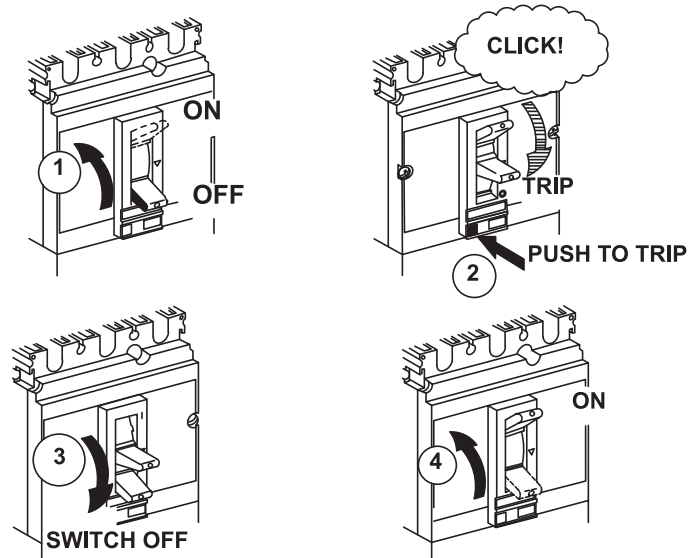

Înterupătoare de sarcină de curent continuu

DC 21B		IP 20	U_i 1.2 kV	U_{imp} 8 kV	I_{cw} IEC 60947-3 5 kA		8mm OFF	[mm²] 35-120	T_o -40..+45°C	x10.000
---------------	--	--------------	-----------------------------	-----------------------------	--	--	----------------	--------------------------------	---------------------------------	----------------

TRACON	I_n 1200 V DC	I_n 1500 V DC	Nm	P_m	I_z
MSDC-250	250 A	200 A	4.0-6.0	45 W	10 kA

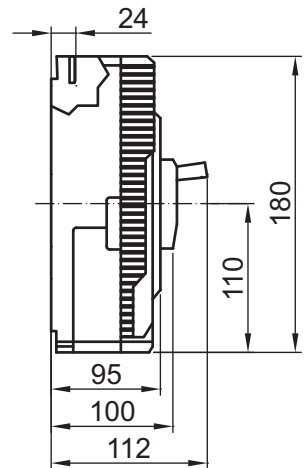
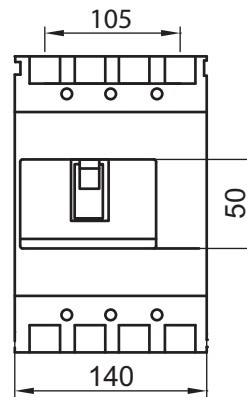
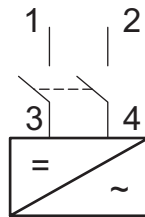

**RELEVANT STANDARD
EN 60947-3**



Siguranțe fuzibile MPR

500 V AC **I_{cu} 120 kA_{eff}** **IP 00** **T_a -5...+55 °C** **2000 m**

Legendă pictograme **I/O**



	I_n	P_v
--	----------------------	----------------------

00C	6-160 A	7,5 W
00	2-160 A	12 W
0	6-160 A	16 W
1	32-250 A	23 W
2	50-400 A	34 W
3	160-630 A	48 W

Materialul carcasei: steatită
 Materialul firului fuzibil: cupru

Siguranța MPR este special proiectată și dimensionată astfel, încât la trecerea unui curent de valoare mai mare decât curentul nominal pentru o perioadă de timp suficient de îndelungat, sau în cazul unui scurtcircuit, ca urmare a încălzirii se topește, deschizând circuitul în care a fost instalat. Astfel, prin întreruperea curentului, protejează atât traseele electrice din circuit cât și consumatorii. Montarea și folosirea lor este eficientă financiar, chiar și cu condiția înlocuirii lor după fiecare scurtcircuit. Capacitatea lor se poate modifica foarte ușor prin schimbarea patronului. Nu au nevoie de întreținere.

Patroanele fuzibile NT... sunt marcate cu simbolul „gG”, a cărui semnificație este capacitatea de întrerupere extinsă pe întregul domeniu în aplicații generale. Simbolul „gG” are aceeași semnificație cu simbolul „gL” din standardul VDE utilizat anterior. Siguranțele fuzibile marcate „aM” pot fi utilizate pentru protecția circuitelor motoarelor electrice.

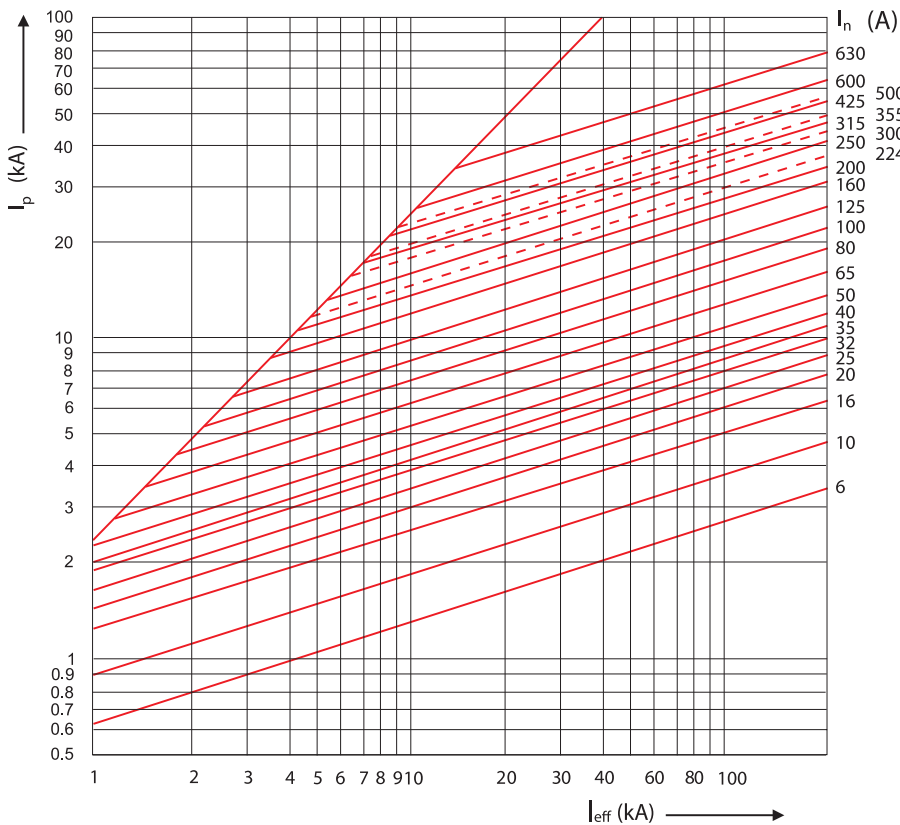

RELEVANT STANDARD
EN 60269-1
EN 60269-2
MSZ HD 60269-2-1

TÜV MEEI TEST DOCUMENTATION
28208126 001
28208128 001
28208130 001
28208132 001

CCA CERTIFICATE NO.
HU 000651
HU 000652
HU 000653
HU 000654

Curba caracteristică de limitare de curent al siguranțelor fuzibile de tip NT... se poate vedea pe diagrama de mai jos. Pe axa orizontală se pot citi valorile curentului nominal de scurtcircuit (I_{eff}), iar pe axa verticală valoarea curentului maxim (I_p).

Ex.: în cazul unei siguranțe de 100A, dacă curentul nominal de scurtcircuit este de 20 kA, curentul maxim are o valoare de aproximativ 11 kA.

Tipodimensiuni

Clasa de putere „00C”

TRACON		I _n
gG	aM	
NT00C-6	-	6 A
NT00C-10	-	10 A
NT00C-16	-	16 A
NT00C-20	-	20 A
NT00C-25	-	25 A
NT00C-32	-	32 A
NT00C-40	-	40 A
NT00C-50	-	50 A
NT00C-63	-	63 A
NT00C-80	-	80 A
NT00C-100	-	100 A
NT00C-125	-	125 A
NT00C-160	-	160 A

Clasa de putere „00”

TRACON		I _n
gG	aM	
-	NTM00-2	2 A
NT00-4	NTM00-4	4 A
NT00-6	NTM00-6	6 A
NT00-10	NTM00-10	10 A
NT00-16	NTM00-16	16 A
NT00-20	NTM00-20	20 A
NT00-25	NTM00-25	25 A
NT00-32	NTM00-32	32 A
NT00-40	NTM00-40	40 A
NT00-50	NTM00-50	50 A
NT00-63	NTM00-63	63 A
NT00-80	NTM00-80	80 A
NT00-100	NTM00-100	100 A
NT00-125	NTM00-125	125 A
NT00-160	NTM00-160	160 A

Clasa de putere „0”

TRACON		I _n
gG	aM	
NT0-6	NTM0-6	6 A
NT0-10	NTM0-10	10 A
NT0-16	NTM0-16	16 A
NT0-20	NTM0-20	20 A
NT0-25	NTM0-25	25 A
NT0-32	NTM0-32	32 A
NT0-40	NTM0-40	40 A
NT0-50	NTM0-50	50 A
NT0-63	NTM0-63	63 A
NT0-80	NTM0-80	80 A
NT0-100	NTM0-100	100 A
NT0-125	NTM0-125	125 A
NT0-160	NTM0-160	160 A

Clasa de putere „1”

TRACON		I _n
gG	aM	
NT1-32	-	32 A
NT1-40	-	40 A
NT1-50	-	50 A
NT1-63	-	63 A
NT1-80	NTM1-80	80 A
NT1-100	NTM1-100	100 A
NT1-125	NTM1-125	125 A
NT1-160	NTM1-160	160 A
NT1-200	NTM1-200	200 A
NT1-224	-	224 A
NT1-250	NTM1-250	250 A

Clasa de putere „2”

TRACON		I _n
gG	aM	
NT2-50	-	50 A
NT2-63	-	63 A
NT2-80	-	80 A
NT2-100	-	100 A
NT2-125	NTM2-125	125 A
NT2-160	NTM2-160	160 A
NT2-200	NTM2-200	200 A
NT2-224	NTM2-224	224 A
NT2-250	NTM2-250	250 A
-	NTM2-300	300 A
NT2-315	NTM2-315	315 A
NT2-355	NTM2-355	355 A
NT2-400	NTM2-400	400 A

Clasa de putere „3”

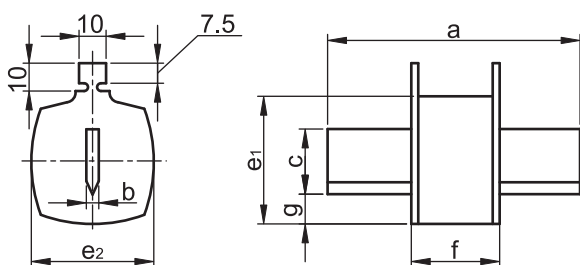

TRACON		I _n
gG	aM	
NT3-160	-	160 A
NT3-200	-	200 A
NT3-315	NTM3-315	315 A
NT3-355	NTM3-355	355 A
NT3-400	NTM3-400	400 A
NT3-425	NTM3-425	425 A
NT3-500	NTM3-500	500 A
NT3-630	NTM3-630	630 A

Desen cotat



NT	a (mm)	f (mm)	g (mm)	c (mm)	e ₁ (mm)	e ₂ (mm)	b (mm)
00C	78±1.5	54-6	11.5	15	45	20	6
00	78±1.5	54-6	11.5	15	45	29	6
0	125±2.5	68-8	11.5	15	45	29	6
1	135±2.5	75-10	12	21	48	48	6
2	150±2.5	75-10	13	27	58	58	6
3	150±2.5	75-10	14	33	67	67	6

Socluri MPR

TRACON			a (mm)	b (mm)	c ₁ (mm)	c ₂ (mm)	d (mm)	e (mm)	l (mm)	k (mm)	i (mm)	u (mm)	q (mm)	m (mm)	v (mm)	f (mm)	∅ (mm)	M (mm)
	NTA-00C-00	00C, 00	30	120	60	85	0	25	8	7.5	100	25	-	25	58	-	8.5	8
	NTA-0	0	30	170	73	93	0	25	16	7.5	150	25	-	38	78	-	8.5	8
	NTA-1	1	58	200	82	96	30	25	16	11	175	25	-	38	82	-	11	10
	NTA-2	2	64	225	98	112	30	25	17	11	200	30	-	40	82	-	11	10
	NTA-3	3	64	250	105	120	30	25	17	11	210	40	-	40	82	-	12.5	12
	NTA-00/3	00C, 00	98	121	61	87	25	65	6.5	7.7	100	26	90	26	54	33	8.5	8
	NTA-1/3	1, 2	170	196	81	103	25	150	10	10	168	35	152	35	73	60	11	10

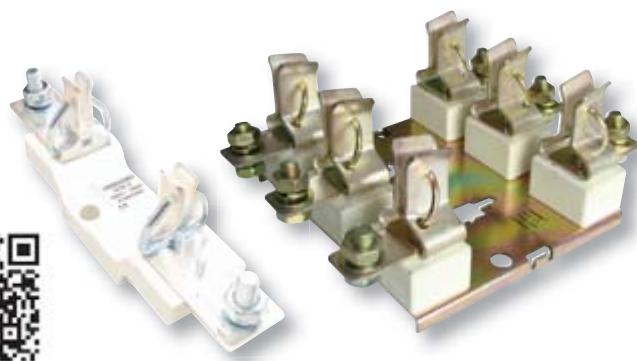
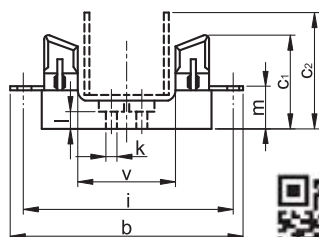
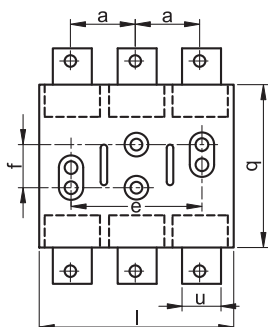
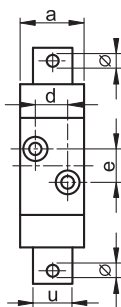

TRACON

**NTA-00C-00 ... NTA-3:**

conexiunile sunt fixate pe o bază din material plastic termorezistent și ignifug

NTA-00/3:

contactele și conexiunile (3 perechi) sunt fixate pe suporturi de porțelan montate pe placă metalică

NTA-1/3:

Cuțite de scurtcircuitare

TRACON		a (mm)	b (mm)	c (mm)	d (mm)
NTR00	00C, 00	45	15	45±1.5	78±1.5
NTR0	0	46	15	62±3	125±2.5
NTR1	1	51	20	62±3	135±2.5
NTR2	2	56	25	62±3	150±2.5
NTR3	3	62	32	65±3	150±2.5

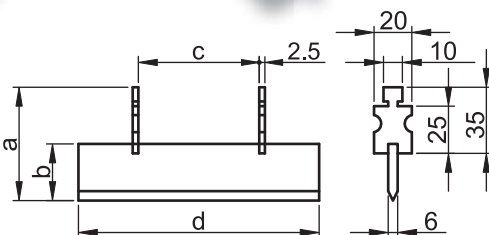
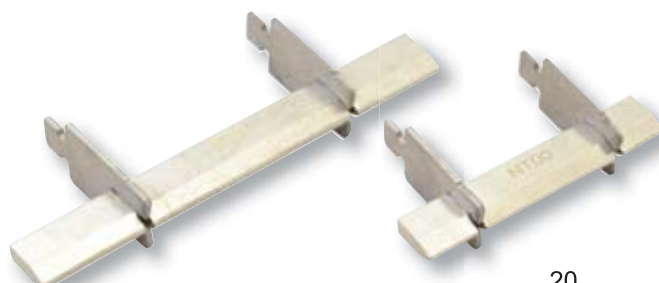

Cuțitele de scurtcircuitare se utilizează la întreruperea conductorilor de nul

Mâner pentru manevrarea elementului fuzibil

TRACON		
NTK	1000 V	00C...3

Cu ajutorul mânerului pentru manevrarea elementului fuzibil se pot scoate cu ușurință elementele fuzibile din soclu. Prin scoaterea elementului fuzibil din soclu se poate întrerupe alimentarea circuitului și acesta devine vizibilă. Se poate utiliza și pentru separarea circuitelor.



Separator cu siguranțe cilindrice



230/400 V AC	IP 20	35×7.5	Ta -25..+55°C	U _i 690 V	V0 UL94	50/60 Hz	2000 m
-----------------	-----------------	--------	------------------	-------------------------	------------	----------	--------



- Alimentare pe ambele părți la alegere, pe sus sau pe jos.
- Pentru siguranțe fuzibile cilindrice: gG (normal) și aM (motor)
- Carcasă nituită
- Variante constructive pentru mai multe faze.
- Capacitate de rupere nominală la scurtcircuit
AC 500 V; 100 kA
AC 690 V; 50 kA
- Carcasă din material plastic neinflamabilă
- Seria EN 60269

**RELEVANT STANDARD
IEC 269-1**

**RELEVANT STANDARD
IEC 269-2**

TRACON	xP	I _n (A)	mm ²		
HBA-1P-20	1P	20 A	1,5-6	8 × 32 mm	
HBA-2P-20	2P	20 A	1,5-6	8 × 32 mm	
HBA-3P-20	3P	20 A	1,5-6	8 × 32 mm	
HBA-1P-32	1P	32 A	1,5-6	10 × 38 mm	
HBA-2P-32	2P	32 A	1,5-6	10 × 38 mm	
HBA-3P-32	3P	32 A	1,5-6	10 × 38 mm	
HBA-1P-50	1P	50 A	1,5-25	14 × 51 mm	
HBA-2P-50	2P	50 A	1,5-25	14 × 51 mm	
HBA-3P-50	3P	50 A	1,5-25	14 × 51 mm	
HBA-1P-100	1P	100 A	1,5-25	22 × 58 mm	
HBA-2P-100	2P	100 A	1,5-25	22 × 58 mm	
HBA-3P-100	3P	100 A	1,5-25	22 × 58 mm	

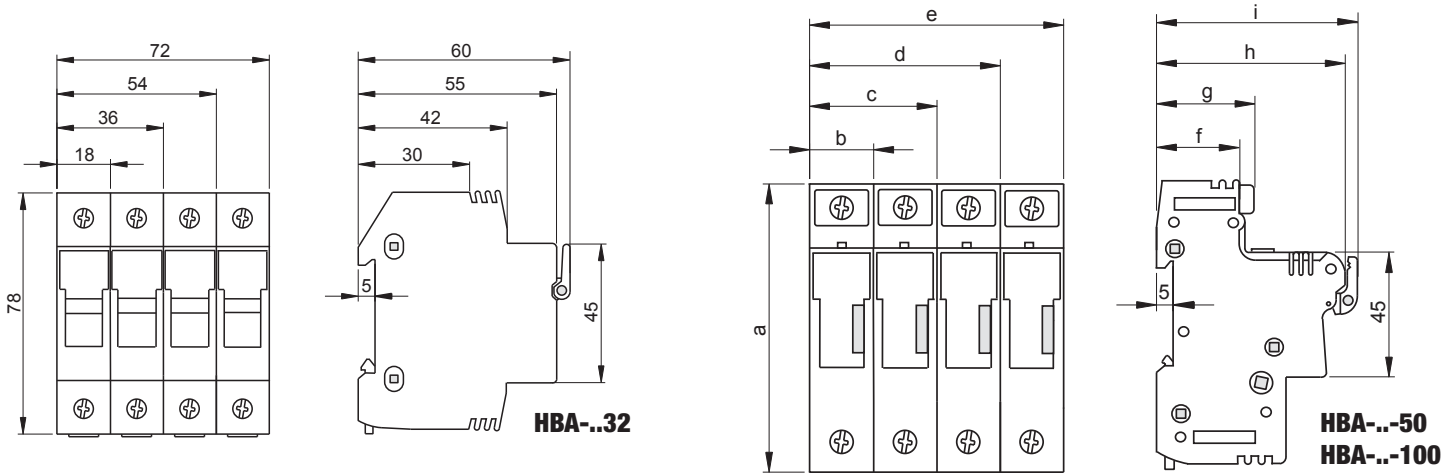
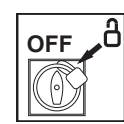

	a (mm)	b (mm)	c (mm)	d (mm)	e (mm)	f (mm)	g (mm)	h (mm)	i (mm)
HBA...-50	107	27	54	81	108	31	39	72.5	77.5
HBA...-100	113	35.5	71	106.5	142	31	39	72.5	77.5

Siguranțe fuzibile cilindrice

8x32 mm

TRACON		I _n
gG	aM	
HB-8x32-2	HBM-8x32-2	2 A
HB-8x32-4	HBM-8x32-4	4 A
HB-8x32-6	HBM-8x32-6	6 A
HB-8x32-8	HBM-8x32-8	8 A
HB-8x32-10	HBM-8x32-10	10 A
HB-8x32-16	HBM-8x32-16	16 A

14x51 mm

TRACON		I _n
gG	aM	
HB-14x51-2	HBM-14x51-2	2 A
HB-14x51-4	HBM-14x51-4	4 A
HB-14x51-6	HBM-14x51-6	6 A
HB-14x51-8	HBM-14x51-8	8 A
HB-14x51-10	HBM-14x51-10	10 A
HB-14x51-16	HBM-14x51-16	16 A
HB-14x51-20	HBM-14x51-20	20 A
HB-14x51-25	HBM-14x51-25	25 A
HB-14x51-32	HBM-14x51-32	32 A
HB-14x51-40	HBM-14x51-40	40 A
HB-14x51-50	HBM-14x51-50	50 A

	D (mm)	L (mm)
8x32	8,5	31,5
10x38	10,3	38
14x51	14,3	51
22x58	22,2	58

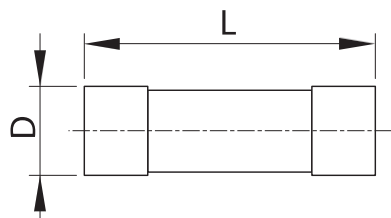

10x38 mm

TRACON		I _n
gG	aM	
HB-10x38-1	HBM-10x38-1	1 A
HB-10x38-2	HBM-10x38-2	2 A
HB-10x38-4	HBM-10x38-4	4 A
HB-10x38-6	HBM-10x38-6	6 A
HB-10x38-8	HBM-10x38-8	8 A
HB-10x38-10	HBM-10x38-10	10 A
HB-10x38-16	HBM-10x38-16	16 A
HB-10x38-20	HBM-10x38-20	20 A
HB-10x38-25	HBM-10x38-25	25 A
HB-10x38-32	HBM-10x38-32	32 A

22x58 mm

TRACON		I _n
gG	aM	
HB-22x58-10	HBM-22x58-10	10 A
HB-22x58-16	HBM-22x58-16	16 A
HB-22x58-20	HBM-22x58-20	20 A
HB-22x58-25	HBM-22x58-25	25 A
HB-22x58-32	HBM-22x58-32	32 A
HB-22x58-40	HBM-22x58-40	40 A
HB-22x58-50	HBM-22x58-50	50 A
HB-22x58-63	HBM-22x58-63	63 A
HB-22x58-80	HBM-22x58-80	80 A
HB-22x58-100	HBM-22x58-100	100 A



CITIȚI CODUL !

- Vezi noutățile noastre
- Fiți informat

Gama de produse se dezvoltă continuu și rapid!
 Catalogul nostru reflectă situația din Octombrie 2017.
 Pentru informații actualizate vizitați pagina
 noastră de internet!

Separatoare orizontale cu siguranțe MPR pentru montaj pe contrapanou



Separatoarele cu siguranțe MPR KETO fabricate de către Jean Müller și sistemele de bare COSMO® precum și accesoriile acestora le puteți găsi în catalogul TRACON ELECTRIC și în magazinul nostru virtual.



Dimensiunile separatoarelor cu siguranțe MPR, datele tehnice detaliate se găsesc pe pagina de internet www.traconelectric.com!

- racordare cu șurub (A) sau cu clemă de strângere (B)
- Variante constructive cu 1, 2, 3 și 4 poli
- 4 grupe de putere, pentru siguranțe MPR grupa 00, 1, 2 și 3
- Modalități de conectare universale, care pot fi montate și ulterior



TRACON	In			mm ²	L (mm)	W (mm)	H (mm)	U _i	U _e
KETO-00-1/F	160	00	A	max. 95, M10	204	50	84	800 VAC	690 VAC, 440 VDC
KETO-00-1/R95			B	1,5-95	204	50	84	800 VAC	690 VAC, 440 VDC
KETO-1-1/F	250	1	A	max. 150, M10	306	69	117	800 VAC	690 VAC, 440 VDC
KETO-3-1/F	400/630A	2-3	A	max. 300, M10	306	91	143	800 VAC	690 VAC, 440 VDC
KETO-00-3/F	160 A	00	A	max. 95, 1×M8/2×M5	204	106	84	800 VAC	690 VAC, 440 VDC
KETO-00-3/R95			B	1,5-95	204	106	84	800 VAC	690 VAC, 440 VDC
KETO-1-3/F	250 A	1	A	max. 150, M10	306	184	117	800 VAC	690 VAC, 440 VDC
KETO-1-3/R150			B	35-150	306	184	117	800 VAC	690 VAC, 440 VDC
KETO-2-3/F	400 A	2	A	max. 240, M10	306	210	117	800 VAC	690 VAC, 440 VDC
KETO-2-3/R300			B	95-300	306	210	117	800 VAC	690 VAC, 440 VDC
KETO-3-3/F	630 A	3	A	max. 300, M10	306	250	117	800 VAC	690 VAC, 440 VDC
KETO-3-3/R300			B	95-300	306	250	117	800 VAC	690 VAC, 440 VDC

CĂUTAȚI CATALOGUL KETO LA SERVICIUL RELAȚII CLIEȚI SAU SOLICITAȚI ACEST LUCRU AGENTULUI DE VÂNZĂRI!



GAMĂ COMPLETĂ!

- Cleme de strângere
- Șine de legătură 00
- Carcase de protecție împotriva atingerii
- Adaptoare pentru șină de montaj, 00-1
- Elemente care pot fi zăvorâte cu lacăt, 00-3
- Indicator de stare
- Monitorizare siguranțe fuzibile
- Protecție împotriva furtului de curent
- Date tehnice
- Desene dimensionale



Separatoare orizontale cu siguranțe MPR, varianta constructivă cu montaj pe bare

Se pot monta ușor și ulterior pe sistemele de bare tripolare deja construite, cu distanța între axele barelor de 60 și 100 mm. Elementele de fixare situate în spatele barelor strâng suprafața conductoare de conexiune (situată pe spatele aparatului) pe bare, asigurând pe lângă fixarea sigură și alimentarea separatorului.

- 3 poli, variantă de racordare: bare/papuci/cleme de strângere
- Distanțele între axele barelor 60 mm și 100 mm
- Grosimea barei 5-10 mm
- Siguranțe MPR grupa 00,1,2 și 3



TRACON		I_n		$a \times b$		mm^2	L (mm)	W (mm)	H (mm)	
KETO-00-3/60/AOU/F		60 mm	160 A	00	20-30 × 5-10	A	max. 95, 1×M8/2×M5	204	106	109
KETO-00-3/60/AOU/R95		60 mm	160 A	00	20-30 × 5-10	B	1,5-95	204	106	109
KETO-00-3/60/AOU/R95T		60 mm	160 A	00	20-30 × 5-10	B	1,5-95	204	106	109
KETO-1-3/60/AOU/F		60 mm	250 A	1	20-30 × 5-10	A	max. 150, M10	306	184	117
KETO-1-3/60/AOU/R150		60 mm	250 A	1	20-30 × 5-10	B	35-150	306	184	117
KETO-2-3/60/AOU/F		60 mm	400 A	2	20-30 × 5-10	A	max. 240, M10	306	210	135
KETO-2-3/60/AOU/R300		60 mm	400 A	2	20-30 × 5-10	B	95-300	306	210	135
KETO-3-3/60/AOU/F		60 mm	630 A	3	20-30 × 5-10	A	max. 300, M10	306	250	143
KETO-3-3/60/AOU/R300		60 mm	630 A	3	20-30 × 5-10	B	95-300	306	250	143
KETO-1-3/100/AOU/F		100 mm	250 A	1	20-50 × 5-10	A	max. 150, M10	306	184	146
KETO-2-3/100/AOU/F		100 mm	400 A	2	20-50 × 5-10	A	max. 240, M10	306	210	144
KETO-3-3/100/AOU/F		100 mm	630 A	3	20-50 × 5-10	A	max. 300, M10	306	250	152

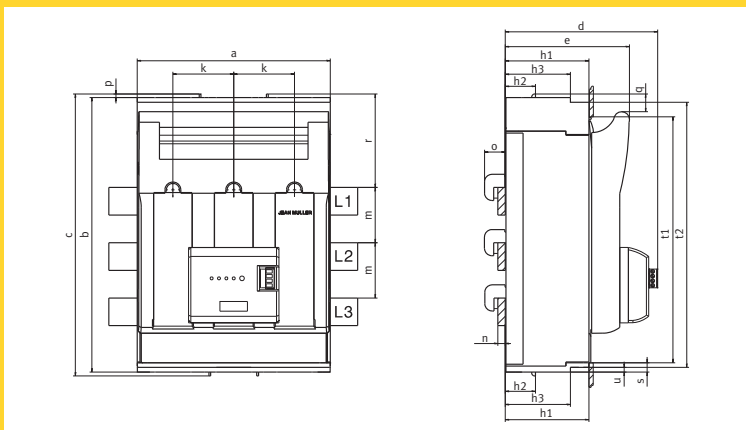

Compania Jean Müller joacă un rol determinant pe piața aparatelor de comutare de curenți mari încă din anul 1897. Produsele sigure, de bună calitate, sunt recunoscute în întreaga lume. Această calitate o puteți observa acum și dumneavoastră.

Separatoare verticale cu siguranțe MPR pentru sisteme de bare cu distanța între axe de 185 mm

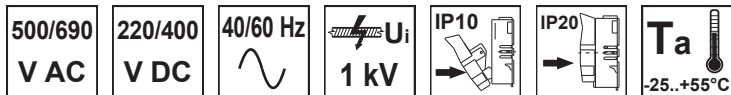









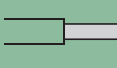

Caracteristici principale:









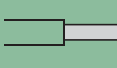

Alegerea conexiunii, superioară sau inferioară a cablului se poate realiza prin rotirea carcasei exterioare.

Găuri concepute în capacul separatorului pentru măsurarea tensiunii.

Varianta cu întreruperea individuală a polilor

TRACON	I_n		 mm ²	L (mm)	W (mm)	H (mm)	
SL00-3X/185/F	160 A	00	Max. 95	662	50	135,5	
SL00-3X/185/KU00	160 A	00	10 – 95	662	50	135,5	
SL1-3X/3A	250 A	1	25 – 150	762	99	194	
SL1-3X/9/KM2G-F	250 A	1	25 – 240	762	99	194	
SL2-3X/3A	400 A	2	25 – 240	762	99	194	
SL2-3X/9/KM2G-F	400 A	2	25 – 240	762	99	194	
SL3-3X/3A	630 A	3	25 – 300	762	99	194	
SL3-3X/9/KM2G-F	630 A	3	25 – 240	762	99	194	

Varianta cu întreruperea simultană a celor 3 poli

TRACON	I_n		 mm ²	L (mm)	W (mm)	H (mm)	
SL00-3X3/185/F	160 A	00	Max. 95	662	50	150	
SL00-3X3/185/KU00	160 A	00	10 – 95	662	50	150	
SL1-3X3/3A	250 A	1	25 – 150	762	99	202	
SL1-3X3/9/KM2G-F	250 A	1	25 – 240	762	99	202	
SL2-3X3/3A	400 A	2	25 – 240	762	99	202	
SL2-3X3/9/KM2G-F	400 A	2	25 – 240	762	99	202	
SL3-3X3/3A	630 A	3	25 – 300	762	99	202	
SL3-3X3/9/KM2G-F	630 A	3	25 – 240	762	99	202	

Braț de cuplare

- Braț de cuplare lung pentru cuplarea sigură și rapidă
- Oricare pol se poate zăvorî în poziție cuplată sau decuplată (în cazul variantei constructive cu întreruperea individuală a polilor)

Măsurare și verificare

- Măsurarea sigură a tensiunii de pe contactul soclului MPR prin găurile de verificare.

Montaj

- Mulțumită carcaselor de protecție a contactelor împotriva atingerii accidentale, montajul se poate realiza în siguranță și sub tensiune.
- Urechi de montare interschimbabile pentru fixarea pe bare



Accesorii utilizabile pentru construirea sistemelor de bare cu distanța între axe de 100 și 185 mm

SH100/185

Suport sistem de bare (pentru sisteme de bare cu distanța între axe de 100 și 185mm)



Suportul este potrivit pentru fixarea barelor cu distanța între axe de 100 și 185 mm. Cu ajutorul lor se poate forma un sistem de bare optim și pentru separatoarele verticale cu siguranțe MPR. Împună cu elementele de acoperire a barelor, care se pot comanda separat, se poate crea un sistem complet din punct de vedere al protecției împotriva atingerii.

Date tehnice:

- Număr de poli: 3
- Mărimea șurubului de fixare: M12
- Lățimea barei: 100 mm
- Distanța între axe: 100 respectiv 185 mm
- Dimensiuni de gabarit: 38×442×25 mm

H-SL123/662

Capac cu șurub pentru bare (pentru sisteme de bare cu distanța între axe 185 mm)



Cu ajutorul capacului frontal, vertical, sistemul de bare trifazat cu distanța între axe de 185 mm poate fi protejat din punct de vedere al protecției împotriva atingerii. Se poate realiza izolarea părților frontale neprotejate pe partea dinspre operator.

Date tehnice:

- Număr de poli: 3
- Mărimea șurubului de fixare: M12
- Lățimea barei: 100 mm
- Distanța între axe: 185 mm
- Dimensiuni de gabarit: 100×662×2 mm

H-RF

Capac înclinetabil pentru bare (pentru sisteme de bare cu distanța între axe 100 și 185 mm)



Au aceeași funcție ca și capacele cu șurub pentru bare, diferă doar modul de montare. Capacul se înclinetază simplu pe bare. Nu este necesară utilizarea uneltelor pentru montare.

Date tehnice:

- Număr de poli: 3
- Mod de fixare: cu urechi de fixare din material plastic
- Lățimea barei: 100 mm
- Distanța între axe: 100 respectiv 185 mm
- Dimensiuni de gabarit: 99×572×36 mm

HW-SH/185

Capac lateral suport de bare (distanța între axe 185 mm)



Cu ajutorul lui se poate realiza izolarea laterală a suportului de bare tip SH100/185. Capacul lateral împreună cu suportul de bare SH100/185 și capacul frontal cu șurub sau cel înclinetabil montat, poate acoperii complet pe partea dinspre operator sistemul de bare cu lățimea de 185 mm.

Date tehnice:

- Număr de poli: 3
- Șuruburi de fixare: urechi de fixare din material plastic
- Distanța între axe: 185 mm
- Dimensiuni de gabarit: 25×442×38 mm

Accesorii utilizabile pentru separatoare verticale cu siguranțe MPR cu distanța între axe de 185 mm



AL-SL00/42

Adaptor pentru ridicarea aparatelor din grupa 00, 00C

Cu ajutorul lui aparatele din grupa 00, 00C se pot ridica din plan, astfel vor ajunge la aceeași înălțime cu aparatele din grupa de putere 1-2-3. Cu aceasta, structura internă a tabloului de distribuție devine mai estetică, manevrarea aparatajului încorporat devine mai simplă.

Date tehnice:

- Număr de poli: 3
- Grupa de putere: 00, 00C
- Mărimea șurubului de fixare: M12
- Lățimea barei : 100 mm
- Distanța între axe : 185 mm
- Dimensiuni de gabarit: 99×450×42 mm



SK-L/SL00/15

Clemă derivație din bare pentru aparatele din grupa 00, 00C

Cu ajutorul lor se pot fixa mai rapid pe bare aparatele din grupa de putere 00, 00C.

Date tehnice:

- Material: cupru stanat
- Grupa aparatului: 00, 00C
- Mărimea șurubului de fixare: M12
- Grosimea barei: 5-10 mm



Sistem de bare COSMO de 60 mm



Soluție completă pentru construirea sistemului de bare cu distanța între axe de 60 mm cu utilizarea elementelor de mai jos.

Caracteristici principale:

- Utilizare pe scară largă
- Timp scurt de instalare
- Cablare mai puțină
- Ușor de montat
- Dimensiuni standardizate



Suporturi de bare și capace aferente (distanța între axe 60 mm)



TRACON	VARIANTĂ CONSTRUCTIVĂ
SST-60/1	Suport de bară, 1P
SST-60/3	Suport sistem de bare, 3P
SST-60/4	Suport sistem de bare, 4P
A-SST-60/3	Capac lateral pentru bare, 3P
A-SST-60/4	Capac lateral pentru bare, 4P
SAD60/3	Capac frontal pentru bare, 3P
SAD60/4	Capac frontal pentru bare, 4P

Suporturi de bare sunt unități confecționate din material izolator, compuși din două părți, cu distanțiere încorporate pentru instalarea barelor cu lățimea de 20-30 mm și 5-10 mm grosime. Capacele acoperă toate cele 3 faze și se pot prinde pe bară cu minim de efort. Capacele montate prin suprapunerea uneia peste cealaltă se pot și mișca, rezultând un capac cu lățime variabilă fără tăiere.

Module derivație (distanța între axe 60 mm)

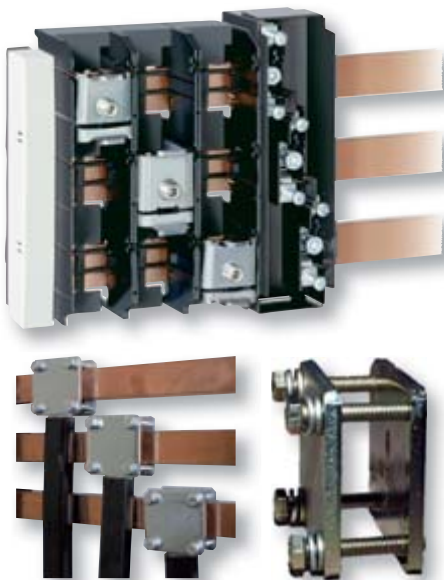

TRACON	VARIANTA CONSTRUCTIVĂ, DERIVAȚIE (LĂȚIME x GROSIME)
AM-60/250/3	până la 250A, 1,5mm ² -70 mm ²
AM-60/250/3/120-5	până la 250A, 16mm ² -120mm ² , pt. bare cu gros. de 5mm
AM-60/250/3/120-10	până la 250A, 16mm ² -120mm ² , pt. bare cu gros. de 10mm
AM-60/630/3	până la 630A, 70mm ² -300mm ² , pt. bare 5/10mm grosime
PK30/34X10	pt. bare flexibile 34×10mm, pe bare de 30 mm lățime
PK40/34X10	pt. bare flexibile 34×10mm, pe bare de 40 mm lățime
PK50/34X10	pt. bare flexibile 34×10 mm, pe bare de 50 mm lățime
PK50/54X10	pt. bare flexibile 54×10 mm, pe bare de 50 mm lățime
PK60/34X10	pt. bare flexibile 34×10 mm, pe bare de 60 mm lățime
PK60/54X10	pt. bare flexibile 54×10 mm, pe bare de 60 mm lățime





Sunt potrivite pentru alimentarea barelor și realizarea derivațiilor de cablu. Modulele tip AM... conțin și carcasa de protecție împotriva atingerii, se pot utiliza și pentru realizarea derivațiilor de cablu de pe bare. Modulele tip PK... sunt variante fără carcasă a cărei șuruburi strâng bara de derivație pe cea principală.

Cleme derivație



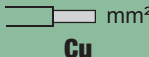

TRACON		
5 mm	10 mm	mm ²
LAK5/1,5-16	LAK10/1,5-16	1,5-16 mm ²
LAK5/1,5-35	LAK10/1,5-35	1,5-35 mm ²
LAK5/1,5-50	LAK10/1,5-50	1,5-50 mm ²
LAK5/16-70	LAK10/16-70	16-70 mm ²
LAK5/16-120	LAK10/16-120	16-120 mm ²
LAK5/16-185	LAK10/16-185	16-185 mm ²

Clemă de strângere

TRACON	 mm ² Cu	 a x b a x b	X 	
S00-Z	6-50	9x5 mm, Cu	2 x M5	00 KETO, SL..
S1	25-150	18x10 mm, Cu	2 x M6	1 KETO
S2	25-240	19x10 mm, Cu	2 x M8	2 KETO
S3	–	21x15 mm, Cu	2 x M8	3 KETO



Cleme tip prismă

TRACON	 mm ² Cu/Al	X 	
P0070-Z	1x10 - 70	2 x M5	00 KETO, SL..
P1	1x70 - 150	2 x M6	1 KETO
P2	1x120 - 240	2 x M8	2 KETO
P3	1x120 - 300	2 x M8	3 KETO
P12	2x70 - 95	2 x M6	1 KETO
P22	2x120 - 150	2 x M8	2 KETO
P32	2x120 - 240	2 x M8	3 KETO





P..



P..2

Cleme de strângere tip V



TRACON	 mm ² Cu/Al	 a x b a x b	
KM2G-F	25-240 mm ² Cu/Al	–	1, 2, 3 SL..
KM2G	25-300 mm ² Cu/Al	–	1, 2, 3 SL..
KM2G-F/A30-40	25-240 mm ² Cu/Al	30-40 mm	
KM2G/A30-40	25-300 mm ² Cu/Al	30-40 mm	



KM2G../A30-40

KM2G..

Cleme de strângere tip U

TRACON	 mm ² Cu/Al	 a x b a x b	
KU00/1/2X/A30-40*	2x10-95 mm ² Cu/Al	30-40 mm	
KU00	10-95 mm ² Cu/Al	–	00 SL..
KU00/2	1x95/2x50mm ² Cu/Al	–	00 SL..



KU00/1/2x30-40

KU00

* Variantă constructivă cu ureche de racord, se poate monta pe bară

Toate separatoarele Jean Müller sunt prevăzute cu contacte cuțit, special concepute în scopul unei funcționări sigure, fiabile a sistemului de distribuție a energiei electrice. Construcția părții superioare a contactului asigură ghidarea optimă a arcului electric, reducând durata arcului electric și cu aceasta reducând eroziunea superficială a contactului.

Suprafața dreaptă de la mijlocul contactului asigură contactul optim și menține pierderea de putere la un nivel scăzut.

Construcția părții inferioare a contactului împiedică sudarea contactelor în cazul cuplării pe un scurtcircuit, astfel capacitatea de rupere la scurtcircuit a separatorului poate fi chiar și 110 kA!



Înterupătoare manuale tip TK



Legendă pictograme

I/O

U_i
690 V

50/60 Hz

U_{imp}
6 kV

T_a
-5..+55 °C



		TK-20	TK-25	TK-32	TK-63	TK-125	TK-160	
I_{th} (A)		20	25	32	63	125	160	
P_e (kW)	400 V~	AC-23A	7,5	11	15	30	45	75
		AC-2	7,5	11	15	30	45	55
		AC-3	5,5	7,5	11	18,5	30	37
		AC-4	1,5	3	5,5	7,5	12	15
I_e (A)	400 V~	AC-21A	20	25	32	63	100	150
		AC-22A	20	25	32	63	100	150
		AC-23A	15	22	30	37	90	135
		AC-2	15	22	30	37	90	135
		AC-3	11	15	22	36	75	95
		AC-4	3,5	6,5	11	15	30	55
		AC-15	4	5	6	-	-	-
	240 V =	DC-13	1	1,5	4	-	-	
	($\times 10^5$)	5	5	3	1,5	1,5	1,5	
	($\times 10^5$)	3	3	1,2	1	1	1	
	ON-OFF-ON... sc/h	200	150	100	60	30	30	
	mm ²		1×2,5	1×4,0	1×6,0	1×25	1×50	1×70
			2×1,5	2×1,5	2×4,0	2×10	2×25	2×35
			1×2,5	1×4,0	1×4,0	1×16	1×35	1×50
			2×1,5	2×1,5	2×2,5	2×6	2×10	2×16
I_{cw} (1s, A)		200	250	400	600	600	800	
	(A)	20	25	32	63	125	160	

Desene cotate și găuri de fixare

TK..., TKV..., TKB..., TKM..., TKU..., TKI-F

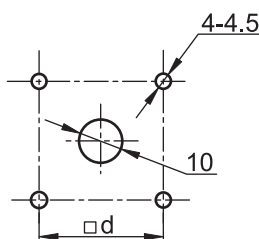
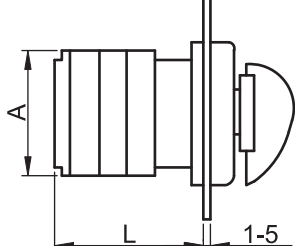
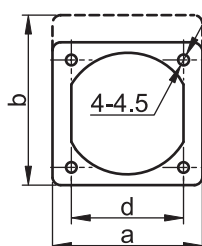

TKF..., TKFL...

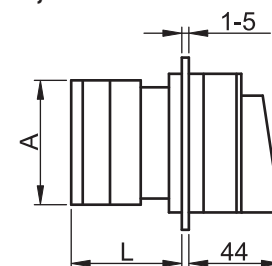
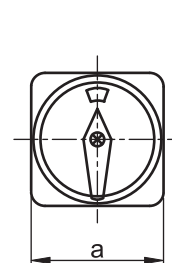

Vezi dimensiunile în tabelul cu variantele constructive ! (I/22-I/27.)



CITIȚI CODUL !

- Vezi noutățile noastre
- Fiți informat

Gama de produse se dezvoltă continuu și rapid!
 Catalogul nostru reflectă situația din Octombrie 2017.
 Pentru informații actualizate vizitați pagina
 noastră de internet!

Carcase

TRACON		D (mm)	W (mm)	H (mm)	a×b (mm)		IP..
TK/T1+F1/		68	68	64	48 × 48	2 × MG-20	IP 44
TK/T2+F1/		68	68	72	48 × 48	2 × MG-20	IP 44
TK/T2+F2/		68	68	80	48 × 48	2 × MG-20	IP 44
TK/T2+F2S/		68	68	80	48 × 48	2 × MG-20	IP 44
TK/T3+F3/		112	112	108	64 × 64	2 × MG-25 2 × MG-32	IP 44
TK/T3+F3S/		112	112	108	64 × 64	2 × MG-25 2 × MG-32	IP 44
TKTS-01		110	83	69	48 × 48/ 64 × 64	2 × (2 × MG-20)	IP 65
TKTS-02		120	113	87	48 × 48/ 64 × 64	2 × (2 × MG-25)	IP 65
TKTS-03		200	140	109	64 × 64/ 88 × 88	2 × MG-25 2 × MG-32	IP 65

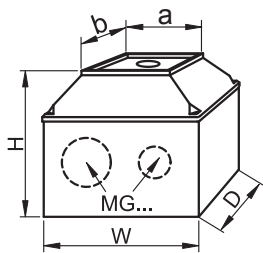

TKTS-..



TK/..S/



TK/..I

**RELEVANT STANDARD
EN 60947-3**

Set de garnituri

TRACON	
TKT-65	TK-20.., TK-25.., TKV-20.., TKV-25.., TKB-20.., TKB-25.., TKM-20.., TKM-25.., TKF-20.., TKF-25..
TKT-65/2	TK-32.., TK-63.., TKV-32.., TKV-63.., TKB-32.., TKB-63.., TKM-32.., TKM-63.., TKF-32.., TKF-63..
TKT-65/3	TKFL-..
TKT-65/4	TKFK-..



**IP
65**



Adaptor

TRACON	
TKA	TK-20.., TK-25.., TKV-20.., TKV-25.., TKB-20.., TKB-25.., TKM-20.., TKM-25.., TKF-20.., TKF-25..



35×7.5



**RELEVANT STANDARD
EN 60947-3**

TRACON

IP 42



+



IP44



+



IP65



Înterupătoare generale ON / OFF

TK-206/2	TK-206/2T	TK-206/2T65	20 A / 2P	TK/T1+F1/
TK-256/2	TK-256/2T	TK-256/2T65	25 A / 2P	TK/T1+F1/
TK-209/2	TK-209/2T	TK-209/2T65	20 A / 2P	TK/T1+F1/
TK-259/2	TK-259/2T	TK-259/2T65	25 A / 2P	TK/T1+F1/
TK-206/3	TK-206/3T	TK-206/3T65	20 A / 3P	TK/T1+F1/
TK-256/3	TK-256/3T	TK-256/3T65	25 A / 3P	TK/T2+F1/
TK-326/3	TK-326/3T	TK-326/3T65	32 A / 3P	TK/T3+F3/
TK-636/3	TK-636/3T	TK-636/3T65	63 A / 3P	TK/T3+F3/
TK-126/3	-	TK-126/3T65	125 A / 3P	TKTS-03
TK-166/3	-	TK-166/3T65	160 A / 3P	TKTS-03
TK-209/3	TK-209/3T	TK-209/3T65	20 A / 3P	TK/T1+F1/
TK-259/3	TK-259/3T	TK-259/3T65	25 A / 3P	TK/T2+F1/
TK-329/3	TK-329/3T	TK-329/3T65	32 A / 3P	TK/T3+F3/
TK-639/3	TK-639/3T	TK-639/3T65	63 A / 3P	TK/T3+F3/
TK-129/3	-	TK-129/3T65	125 A / 3P	TKTS-03
TK-169/3	-	TK-169/3T65	160 A / 3P	TKTS-03
TK-206/4	TK-206/4T	TK-206/4T65	20 A / 4P	TK/T1+F1/
TK-256/4	TK-256/4T	TK-256/4T65	25 A / 4P	TK/T2+F1/
TK-326/4	TK-326/4T	TK-326/4T65	32 A / 4P	TK/T3+F3/
TK-636/4	TK-636/4T	TK-636/4T65	63 A / 4P	TK/T3+F3/
TK-126/4	-	TK-126/4T65	125 A / 4P	TKTS-03
TK-166/4	-	TK-166/4T65	160 A / 4P	TKTS-03
TK-209/4	TK-209/4T	TK-209/4T65	20 A / 4P	TK/T1+F1/
TK-259/4	TK-259/4T	TK-259/4T65	25 A / 4P	TK/T2+F1/
TK-329/4	TK-329/4T	TK-329/4T65	32 A / 4P	TK/T3+F3/
TK-639/4	TK-639/4T	TK-639/4T65	63 A / 4P	TK/T3+F3/
TK-129/4	-	TK-129/4T65	125 A / 4P	TKTS-03
TK-169/4	-	TK-169/4T65	160 A / 4P	TKTS-03

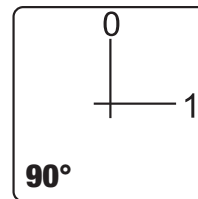
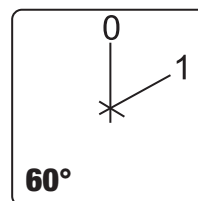
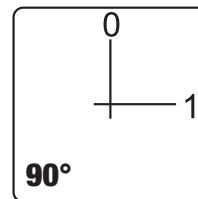
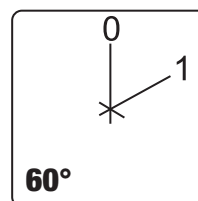
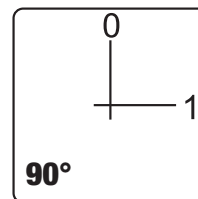
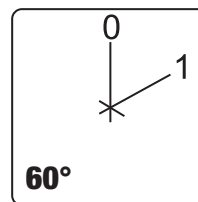

Selectoare

TKV-206/3	TKV-206/3T	TKV-206/3T65	20 A / 2x3P	TK/T2+F1/
TKV-256/3	-	TKV-256/3T65	25 A / 2x3P	TKTS-02
TKV-326/3	TKV-326/3T	TKV-326/3T65	32 A / 2x3P	TK/T3+F3/
TKV-636/3	-	TKV-636/3T65	63 A / 2x3P	TKTS-03
TKV-126/3	-	-	125 A / 2x3P	-
TKV-166/3	-	-	160 A / 2x3P	-
TKV-206/4	-	TKV-206/4T65	20 A / 2x4P	TKTS-01
TKV-256/4	-	TKV-256/4T65	25 A / 2x4P	TKTS-02
TKV-326/4	TKV-326/4T	TKV-326/4T65	32 A / 2x4P	TK/T3+F3/
TKV-636/4	-	-	63 A / 2x4P	-
TKV-126/4	-	-	125 A / 2x4P	-
TKV-166/4	-	-	160 A / 2x4P	-

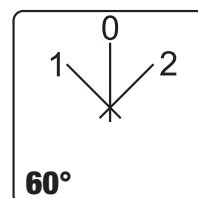
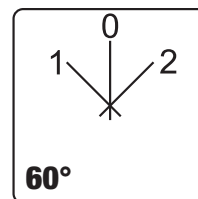

					L (mm)	A (mm)	a (mm)	b (mm)	d (mm)		
		0°	60°								
1-2			×							1 3	
3-4			×							2 4	
				28	43,5	48	48	36			
				28	43,5	48	48	36			
		0°	90°								
1-2			×							1 3	
3-4			×							2 4	
				33	45,3	48	48	36			
				33	45,3	48	48	36			
		0°	60°								
1-2			×	41,2	43	48	48	36		1 3 5	
3-4			×	48,6	45,2	48	48	36		2 4 6	
5-6			×	54,8	58	64	64	48			
				72,2	66	64	64	48			
				84	84	88	88	68			
				97	88	88	88	68			
		0°	90°								
1-2			×	41,2	43	48	48	36		1 3 5	
3-4			×	48,6	45,2	48	48	36		2 4 6	
5-6			×	54,8	58	64	64	48			
				72,2	66	64	64	48			
				84	84	88	88	68			
				97	88	88	88	68			
		0°	60°								
1-2			×	41,2	43	48	48	36		1 3 5 7	
3-4			×	48,6	45,2	48	48	36		2 4 6 8	
5-6			×	54,8	58	64	64	48			
7-8			×	72,2	66	64	64	48			
				84	84	88	88	68			
				97	88	88	88	68			
		0°	90°								
1-2			×	41,2	43	48	48	36		1 3 5 7	
3-4			×	48,6	45,2	48	48	36		2 4 6 8	
5-6			×	54,8	58	64	64	48			
7-8			×	72,2	66	64	64	48			
				84	84	88	88	68			
				97	88	88	88	68			
		-60°	0°	60°							
1-2			×		50,8	43	48	48	36	2 4 6 8 10 12	
3-4				×	61,4	45,2	48	48	36	1 3 5 7 9 11	
5-6			×		67,6	58	64	64	48		
7-8				×	93,7	66	64	64	48		
9-10			×		110	84	88	88	68		
11-12				×	130	88	88	88	68		
		-60°	0°	60°							
1-2			×		9-10	×	60,4	43	48	48	36
3-4				×	11-12		74,2	45,2	48	48	36
5-6			×		13-14	×	80,4	58	64	64	48
7-8				×	15-16		115,2	66	64	64	48
							136	84	88	88	68
							163	88	88	88	68



TRACON

IP 42



+



+





Selectoare

TKV-209/3	TKV-209/3T	TKV-209/3T65	20 A / 2×3P	TK/T2+F1/	
TKV-259/3	-	TKV-259/3T65	25 A / 2×3P	TKTS-02	
TKV-329/3	TKV-329/3T	TKV-329/3T65	32 A / 2×3P	TK/T3+F3/	
TKV-639/3	-	TKV-639/3T65	63 A / 2×3P	TKTS-03	
TKV-129/3	-	-	125 A / 2×3P	-	
TKV-169/3	-	-	160 A / 2×3P	-	
TKV-209/4	-	TKV-209/4T65	20 A / 2×4P	TKTS-01	
TKV-259/4	-	TKV-259/4T65	25 A / 2×4P	TKTS-02	
TKV-329/4	TKV-329/4T	TKV-329/4T65	32 A / 2×4P	TK/T3+F3/	
TKV-639/4	-	-	63 A / 2×4P	-	
TKV-129/4	-	-	125 A / 2×4P	-	
TKV-169/4	-	-	160 A / 2×4P	-	
TKB-206/3	TKB-206/3T	TKB-206/3T65	20 A / 2×3P	TK/T2+F1/	
TKB-256/3	-	TKB-256/3T65	25 A / 2×3P	TKTS-02	
TKB-326/3	TKB-326/3T	TKB-326/3T65	32 A / 2×3P	TK/T3+F3/	
TKB-636/3	-	TKB-636/3T65	63 A / 2×3P	TKTS-03	
TKB-126/3	-	-	125 A / 2×3P	-	
TKB-166/3	-	-	160 A / 2×3P	-	
TKB-206/4	-	TKB-206/4T65	20 A / 2×4P	TKTS-01	
TKB-256/4	-	TKB-256/4T65	25 A / 2×4P	TKTS-02	
TKB-326/4	TKB-326/4T	TKB-326/4T65	32 A / 2×4P	TK/T3+F3/	
TKB-636/4	-	-	63 A / 2×4P	-	
TKB-126/4	-	-	125 A / 2×4P	-	
TKB-166/4	-	-	160 A / 2×4P	-	
TKB-209/3	TKB-209/3T	TKB-209/3T65	20 A / 2×3P	TK/T2+F1/	
TKB-259/3	-	TKB-259/3T65	25 A / 2×3P	TKTS-02	
TKB-329/3	TKB-329/3T	TKB-329/3T65	32 A / 2×3P	TK/T3 +F3/	
TKB-639/3	-	TKB-639/3T65	63 A / 2×3P	TKTS-03	
TKB-129/3	-	-	125 A / 2×3P	-	
TKB-169/3	-	-	160 A / 2×3P	-	
TKB-209/4	-	TKB-209/4T65	20 A / 2×4P	TKTS-01	
TKB-259/4	-	TKB-259/4T65	25 A / 2×4P	TKTS-02	
TKB-329/4	TKB-329/4T	TKB-329/4T65	32 A / 2×4P	TK/T3+F3/	
TKB-639/4	-	-	63 A / 2×4P	-	
TKB-129/4	-	-	125 A / 2×4P	-	
TKB-169/4	-	-	160 A / 2×4P	-	

Înterupătoare pentru motoare electrice

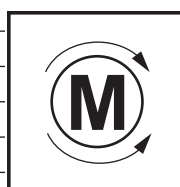
TKM-20/Q	TKM-20/QT	TKM-20/QT65	5,5 kW	TK/T1+F1/	
TKM-25/Q	TKM-25/QT	TKM-25/QT65	7,5 kW	TK/T2+F1/	
TKM-32/Q	TKM-32/QT	TKM-32/QT65	11 kW	TK/T3+F3/	
TKM-63/Q	TKM-63/QT	TKM-63/QT65	18,5 kW	TK/T3+F3/	
TKM-12/Q	-	TKM-12/QT65	30 kW	TKTS-03	
TKM-16/Q	-	TKM-16/QT65	37 kW	TKTS-03	
TKM-20/N	TKM-20/NT	TKM-20/NT65	5,5 kW	TK/T2+F1/	
TKM-25/N	-	TKM-25/NT65	7,5 kW	TKTS-02	
TKM-32/N	TKM-32/NT	TKM-32/NT65	11 kW	TK/T3+F3/	
TKM-63/N	-	TKM-63/NT65	18,5 kW	TKTS-03	
TKM-12/N	-	-	30 kW	-	
TKM-16/N	-	-	37 kW	-	

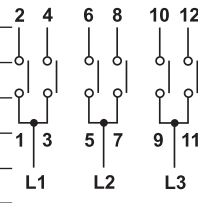

<table border="1"> <tr><td>1</td><td>0</td><td>2</td></tr> <tr><td>x</td><td>x</td><td>x</td></tr> <tr><td>2</td><td>x</td><td>x</td></tr> <tr><td>3</td><td>x</td><td>x</td></tr> </table>			1	0	2	x	x	x	2	x	x	3	x	x	L (mm)	A (mm)	a (mm)	b (mm)	d (mm)	<table border="1"> <tr><td>1</td><td>3</td><td>5</td><td>7</td></tr> <tr><td>2</td><td>4</td><td>6</td><td>8</td></tr> </table>	1	3	5	7	2	4	6	8				
1	0	2																														
x	x	x																														
2	x	x																														
3	x	x																														
1	3	5	7																													
2	4	6	8																													
-90°	0°	90°																														
1-2	x			50,8	43	48	48	36	2	4	6	8	10	12																		
3-4			x	61,4	45,2	48	48	36																								
5-6	x			67,6	58	64	64	48																								
7-8			x	93,7	66	64	64	48																								
9-10	x			110	84	88	88	68	1	3	5	7	9	11																		
11-12			x	130	88	88	88	68	L1		L2		L3																			
-90°	0°	90°	-90°	0°	90°																											
1-2	x		9-10	x		60,4	43	48	48	36																						
3-4			11-12		x	74,2	45,2	48	48	36	2	4	6	8	10	12																
5-6	x		13-14	x		80,4	58	64	64	48																						
7-8			15-16		x	115,2	66	64	64	48																						
						136	84	88	88	68	L1	L2	L3	N																		
						163	88	88	88	68																						
-60°	0°	60°																														
1-2	x					50,8	43	48	48	36	2	4	6	8	10	12																
3-4			x			61,4	45,2	48	48	36																						
5-6	x					67,6	58	64	64	48																						
7-8			x			93,7	66	64	64	48																						
9-10	x					110	84	88	88	68	1	3	5	7	9	11																
11-12			x			130	88	88	88	68	L1		L2		L3																	
-60°	0°	60°	-60°	0°	60°																											
1-2	x		9-10	x		60,4	43	48	48	36																						
3-4			11-12		x	74,2	45,2	48	48	36	2	4	6	8	10	12																
5-6	x		13-14	x		80,4	58	64	64	48																						
7-8			15-16		x	115,2	66	64	64	48																						
						136	84	88	88	68	L1	L2	L3	N																		
						163	88	88	88	68																						
-90°	0°	90°																														
1-2	x					50,8	43	48	48	36	2	4	6	8	10	12																
3-4			x			61,4	45,2	48	48	36																						
5-6	x					67,6	58	64	64	48																						
7-8			x			93,7	66	64	64	48																						
9-10	x					110	84	88	88	68	1	3	5	7	9	11																
11-12			x			130	88	88	88	68	L1		L2		L3																	
-90°	0°	90°	-90°	0°	90°																											
1-2	x		9-10	x		60,4	43	48	48	36																						
3-4			11-12		x	74,2	45,2	48	48	36	2	4	6	8	10	12																
5-6	x		13-14	x		80,4	58	64	64	48																						
7-8			15-16		x	115,2	66	64	64	48																						
						136	84	88	88	68	L1	L2	L3	N																		
						163	88	88	88	68																						
0	60°																															
1-2	x					41,2	43	48	48	36																						
3-4	x					48,6	45,2	48	48	36																						
5-6	x					54,8	58	64	64	48																						
						72,2	66	64	64	48																						
						84	84	88	88	68																						
						97	88	88	88	68																						
-60°	0°	60°																														
1-2	x		x			50,8	43	48	48	36																						
3-4	x		x			61,4	45,2	48	48	36																						
5-6	x					67,6	58	64	64	48																						
7-8			x			93,7	66	64	64	48																						
9-10			x			111	84	88	88	68																						
11-12	x					130	88	88	88	68																						

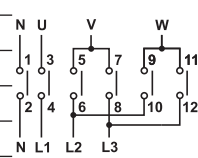
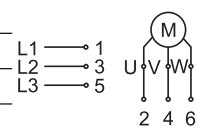

TRACON

IP 42



+

IP44



+

IP65



Înterupătoare pentru motoare electrice

TKM-20/C	-	TKM-20/CT65	Y-Δ 5,5 kW	TKTS-01
TKM-25/C	-	TKM-25/CT65	Y-Δ 7,5 kW	TKTS-02
TKM-32/C	TKM-32/CT	TKM-32/CT65	Y-Δ 11 kW	TK/T3+F3/
TKM-63/C	-	-	Y-Δ 18,5 kW	-
TKM-12/C	-	-	Y-Δ 30 kW	-
TKM-16/C	-	-	Y-Δ 37 kW	-
TKM-20/D	-	TKM-20/DT65	Dahlander 5,5 kW	TKTS-01
TKM-25/D	-	TKM-25/DT65	Dahlander 7,5 kW	TKTS-02
TKM-32/D	TKM-32/DT	TKM-32/DT65	Dahlander 11 kW	TK/T3+F3/
TKM-63/D	-	-	Dahlander 18,5 kW	-
TKM-12/D	-	-	Dahlander 30 kW	-
TKM-16/D	-	-	Dahlander 37 kW	-

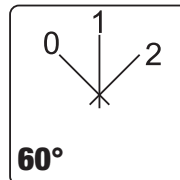
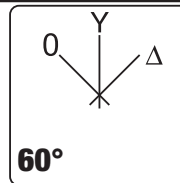

Comutatoare pt. instrumente

TKU-F	-	-	Comutator voltmetric; tensiune pe fază	-
TKU-V	-	-	Comutator voltmetric; tensiune pe linie	-
TKU-K	-	-	Comutator voltmetric; tensiune pe linie și fază	-
TKI-F	-	-	Comutator ampermetric; curent pe fază	-

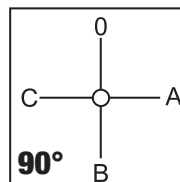
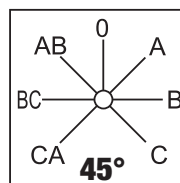
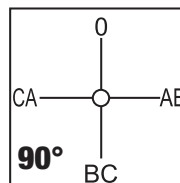
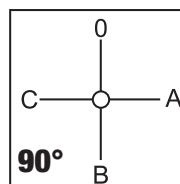

Înterupătoare principale

TKF-20	TKF-20T	TKF-20T65	20 A / 4P	TK/T3+F3/
TKF-25	TKF-25T	TKF-25T65	25 A / 4P	TK/T3+F3/
TKF-32	TKF-32T	TKF-32T65	32 A / 4P	TK/T3+F3/
TKF-63	TKF-63T	TKF-63T65	63 A / 4P	TK/T3+F3/
TKFK-20	TKFK-20T	TKFK-20T65	20 A / 4P	TK/T2+F2/
TKFK-25	TKFK-25T	TKFK-25T65	25 A / 4P	TK/T2+F2/
TKFK-32	-	-	32 A / 4P	-
TKFK-63	-	-	63 A / 4P	-
TKFL-20	TKFL-20TS	TKFL-20T65S	20 A / 4P	TK/T3+F3S/
TKFL-25	TKFL-25TS	TKFL-25T65S	25 A / 4P	TK/T3+F3S/
TKFL-32	TKFL-32TS	TKFL-32T65S	32 A / 4P	TK/T3+F3S/
TKFL-63	TKFL-63TS	TKFL-63T65S	63 A / 4P	TK/T3+F3S/

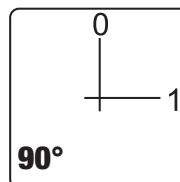
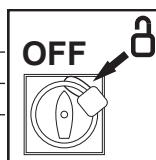
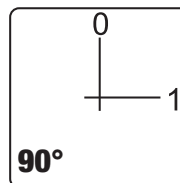
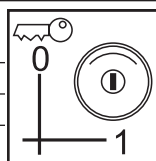
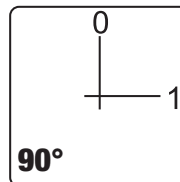

<table border="1"> <tr><td>1</td><td>0</td><td>2</td></tr> <tr><td>x</td><td>x</td><td>x</td></tr> <tr><td>2</td><td>x</td><td>x</td></tr> <tr><td>3</td><td>x</td><td>x</td></tr> </table>			1	0	2	x	x	x	2	x	x	3	x	x	L	A	a	b	d	<table border="1"> <tr><td>1</td><td>3</td><td>5</td><td>7</td></tr> <tr><td>2</td><td>4</td><td>6</td><td>8</td></tr> </table>	1	3	5	7	2	4	6	8
1	0	2																										
x	x	x																										
2	x	x																										
3	x	x																										
1	3	5	7																									
2	4	6	8																									
-60°	0°	60°	-60°	0°	60°	(mm)	(mm)	(mm)	(mm)	(mm)																		
1-2	x	x	9-10	x		57	44	48	48	36																		
3-4	x	x	11-12	x		70	46	48	48	36																		
5-6		x	13-14		x	78	58	64	64	48																		
7-8		x	15-16		x	112	66	64	64	48																		
						138	84	88	88	68																		
						163	88	88	88	68																		
<hr/>																												
-60°	0°	60°	-60°	0°	60°																							
1-2		x	9-10		x	57	44	48	48	36																		
3-4		x	11-12		x	70	46	48	48	36																		
5-6	x		13-14	x		78	58	64	64	48																		
7-8	x		15-16		x	112	66	64	64	48																		
						138	84	88	88	68																		
						163	88	88	88	68																		
<hr/>																												
0	A	B	C																									
1-2	x																											
3-4			x																									
5-6		x																										
9-10	x	x	x				50,8	43	48	48	36																	
<hr/>																												
0	AB	BC	CA																									
1-2	x	x																										
5-6			x																									
7-8	x																											
11-12		x	x				50,8	43	48	48	36																	
<hr/>																												
CA	BC	AB	0	A	B	C																						
1-2		x				x																						
3-4	x																											
5-6					x																							
7-8		x	x							50,8	43																	
9-10	x		x	x						48	48																	
11-12				x	x	x				48	36																	
<hr/>																												
0	A	B	C																									
1-2	x	x	x																									
5-6	x	x	x																									
7-8	x	x	x																									
9-10	x	x	x				60,4	43	48	48	36																	
13-14	x																											
15-16			x																									
<hr/>																												
0°	90°																											
1-2	x																											
3-4	x							41,2	43	64	64																	
5-6	x							48,6	45,2	64	64																	
7-8	x							54,8	58	64	64																	
									72,2	66	64																	
<hr/>																												
0°	90°																											
1-2	x																											
3-4	x							41,2	43	48	48																	
5-6	x							48,6	45,2	48	48																	
7-8	x							75	58/105	64	64/112																	
									93	66/105	64	64/122																
<hr/>																												
0°	90°																											
1-2	x																											
3-4	x							44,2	43	64	64																	
5-6	x							52,1	45,2	64	64																	
7-8	x							54,8	58	64	64																	
									72,2	66	64																	



Întreprupătoare separatoare TS



Legendă
pictograme

I/O

		TS-20	TS-32	TS-40	TS-63	TS-80	TS-100
I_{th} (A)		20	32	40	63	80	100
P_e (kW), 400 V~	AC-23A	7,5	11	15	22	30	37
	AC-3	5,5	7,5	11	18,5	22	30
(×10⁵)		5	5	3	1,5	1,5	1,5
(×10⁵)		3	3	1,2	1	1	1
		200	150	100	60	30	30
mm²		1×2,5	1×4,0	1×6,0	1×25	1×50	1×70
		2×1,5	2×1,5	2×4,0	2×10	2×25	2×35
		1×2,5	1×4,0	1×4,0	1×16	1×35	1×50
		2×1,5	2×1,5	2×2,5	2×6	2×10	2×16
I_{cw} (1s, A)		180	264	360	516	684	840
		20 A gG	35 A gG	50 A gG	63 A gG	80 A gG	100 A gG

Schemă de conexiune

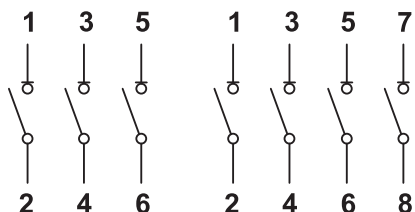

Panou frontal

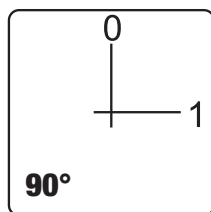

Caracteristici principale:

- se pot utiliza pentru acționări sub sarcină;
- domenii de aplicare: pornirea / oprirea motoarelor electrice, întrerupător principal, separator, întrerupător de securitate
- înaltă fiabilitate mecanică și electrică;
- contacte cu dublă întrerupere;
- viteza de cuplare / decuplare este independentă de acționarea manuală;
- părțile sub tensiune sunt protejate la atingere accidentală;
- Corpul este din material ignifug conform UL94-V0, izolator, de înaltă rezistență mecanică;



RELEVANT STANDARD
EN 60947-3



Separatoare

TRACON						L	A	B	a	d	c
IP 42	IP44	IP65				(mm)	(mm)	(mm)	(mm)	(mm)	(mm)
TS-20/3	TS-20/3T	TS-20/3T65	20 A / 3P			61	54	42	64	48	4.2
TS-32/3	TS-32/3T	TS-32/3T65	32 A / 3P			61	54	42	64	48	4.2
TS-40/3	TS-40/3T	TS-40/3T65	40 A / 3P	TK/T3+F3/		67	64	50	64	48	4.2
TS-63/3	TS-63/3T	TS-63/3T65	63 A / 3P			67	64	50	64	48	4.2
TS-80/3	-	TS-80/3T65	80 A / 3P	TKTS-03		82	80	70	64	48	4.2
TS-10/3	-	TS-10/3T65	100 A / 3P	TKTS-03		82	80	70	88	68	5.2
TS-20/4	TS-20/4T	TS-20/4T65	20 A / 4P			61	54	55.5	64	48	4.2
TS-32/4	TS-32/4T	TS-32/4T65	32 A / 4P			61	54	55.5	64	48	4.2
TS-40/4	TS-40/4T	TS-40/4T65	40 A / 4P	TK/T3+F3/		67	64	66	64	48	4.2
TS-63/4	TS-63/4T	TS-63/4T65	63 A / 4P			67	64	66	64	48	4.2
TS-80/4	-	-	80 A / 4P	-		82	80	92.5	64	48	4.2
TS-10/4	-	-	100 A / 4P	-		82	80	92.5	88	68	5.2

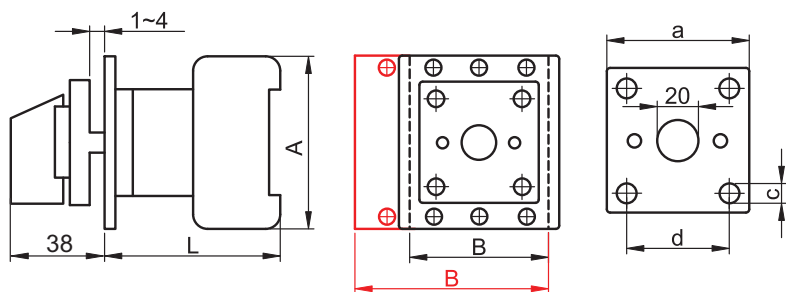

Separator cu dispozitiv de blocare a ușii

TRACON		L	A	B	a	d	c	x	y
		(mm)	(mm)	(mm)	(mm)	(mm)	(mm)	(mm)	(mm)
TS-20/3K	20 A / 3P	50	54	42	64	48	4.2	22	62
TS-32/3K	32 A / 3P	50	54	42	64	48	4.2	22	62
TS-40/3K	40 A / 3P	61	64	50	64	48	4.2	25	70
TS-63/3K	63 A / 3P	61	64	50	64	48	4.2	25	70
TS-80/3K	80 A / 3P	68	80	70	64	48	4.2	25	90
TS-10/3K	100 A / 3P	68	80	70	88	68	5.2	25	90
TS-20/4K	20 A / 4P	50	54	55.5	64	48	4.2	22	62
TS-32/4K	32 A / 4P	50	54	55.5	64	48	4.2	22	62
TS-40/4K	40 A / 4P	61	64	66	64	48	4.2	25	70
TS-63/4K	63 A / 4P	61	64	66	64	48	4.2	25	70
TS-80/4K	80 A / 4P	68	80	92.5	64	48	4.2	25	90
TS-10/4K	100 A / 4P	68	80	92.5	88	68	5.2	25	90



35x7.5

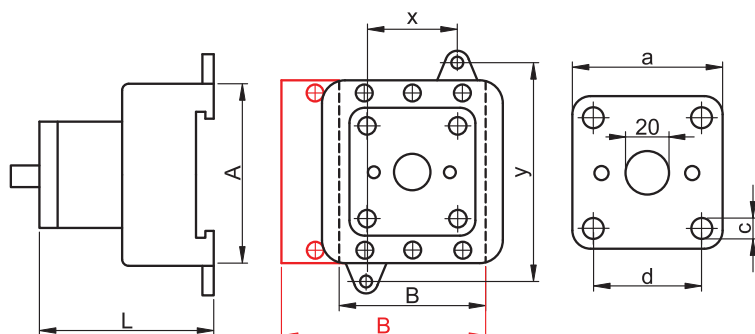

Dispozitivul de blocare asigură zăvorărea de securitate al ușii cutiei de distribuție. Ușa poate fi deschisă doar în poziția „0” (Oprit) al separatorului.

Lungimea axului: 150 mm

Se poate comanda și ax cu lungimea de 300 mm.

Se poate fixa pe spate cu ajutorul a 2 șuruburi sau se montează pe șină omega 35/7,5 mm, conform EN 50022.

Înterupătoare separatoare de siguranță cu zăvorîre prin lacăt

TRACON					L	A	B	a	d	c
IP 42	IP44	IP65			(mm)	(mm)	(mm)	(mm)	(mm)	(mm)
TSS-20/3	TSS-20/3T	TSS-20/3T65S	20 A / 3P	TK/T3+F3/	61	54	42	64	48	4.2
TSS-32/3	TSS-32/3T	TSS-32/3T65S	32 A / 3P		61	54	42	64	48	4.2
TSS-40/3	TSS-40/3T	TSS-40/3T65S	40 A / 3P	TK/T3+F3S/	67	64	50	64	48	4.2
TSS-63/3	TSS-63/3T	TSS-63/3T65S	63 A / 3P		67	64	50	64	48	4.2
TSS-80/3	-	TSS-80/3T65	80 A / 3P	TKTS-03	82	80	70	64	48	4.2
TSS-10/3	-	TSS-10/3T65	100 A / 3P	TKTS-03	82	80	70	88	68	5.2
TSS-20/4	TSS-20/4T	TSS-20/4T65S	20 A / 4P		61	54	55.5	64	48	4.2
TSS-32/4	TSS-32/4T	TSS-32/4T65S	32 A / 4P	TK/T3+F3S/	61	54	55.5	64	48	4.2
TSS-40/4	TSS-40/4T	TSS-40/4T65S	40 A / 4P		67	64	66	64	48	4.2
TSS-63/4	TSS-63/4T	TSS-63/4T65S	63 A / 4P	TK/T3+F3/	67	64	66	64	48	4.2
TSS-80/4	-	-	80 A / 4P	-	82	80	92.5	64	48	4.2
TSS-10/4	-	-	100 A / 4P	-	82	80	92.5	88	68	5.2

Carcasele se pot comanda și cu capac galben

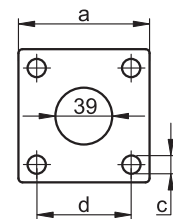
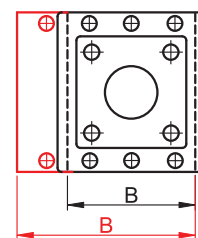
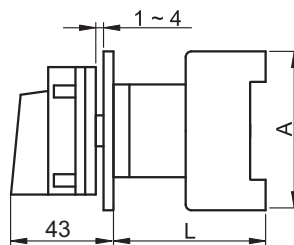

Zăvorîrea cu lacăt este posibilă numai în poziția „0” (OFF) a înterupătorului

Înterupătoare separatoare de siguranță cu zăvorîre prin lacăt și dispozitive de blocare



TRACON		L	A	B	a	d	c	x	y
		(mm)	(mm)	(mm)	(mm)	(mm)	(mm)	(mm)	(mm)
TSS-20/3K	20 A / 3P	50	54	42	64	48	4.2	22	62
TSS-32/3K	32 A / 3P	50	54	42	64	48	4.2	22	62
TSS-40/3K	40 A / 3P	61	64	50	64	48	4.2	25	70
TSS-63/3K	63 A / 3P	61	64	50	64	48	4.2	25	70
TSS-80/3K	80 A / 3P	68	80	70	64	48	4.2	25	90
TSS-10/3K	100 A / 3P	68	80	70	88	68	5.2	25	90
TSS-20/4K	20 A / 4P	50	54	55.5	64	48	4.2	22	62
TSS-32/4K	32 A / 4P	50	54	55.5	64	48	4.2	22	62
TSS-40/4K	40 A / 4P	61	64	66	64	48	4.2	25	70
TSS-63/4K	63 A / 4P	61	64	66	64	48	4.2	25	70
TSS-80/4K	80 A / 4P	68	80	92.5	64	48	4.2	25	90
TSS-10/4K	100 A / 4P	68	80	92.5	88	68	5.2	25	90

Dispozitivul de blocare asigură zăvorîrea de securitate al ușii cutiei de distribuție. Ușa poate fi deschisă doar în poziția „0” (Oprit) al separatorului.

Lungimea axului: 150 mm

Se poate comanda și ax cu lungimea de 300 mm.

Se poate fixa pe spate cu ajutorul a 2 șuruburi sau se montează pe șină omega 35/7,5 mm, conform EN 50022.

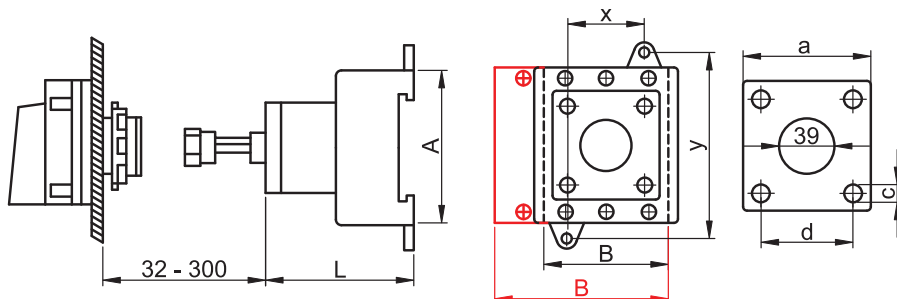

Întreprupător separator modular cu zăvorâre prin lacăt

TRACON		L (mm)	A (mm)	B (mm)	x (mm)	y (mm)
TSM-20/3	20 A / 3P	50	54	42	22	62
TSM-32/3	32 A / 3P	50	54	42	22	62
TSM-20/4	20 A / 4P	50	54	55.5	22	62
TSM-32/4	32 A / 4P	50	54	55.5	22	62

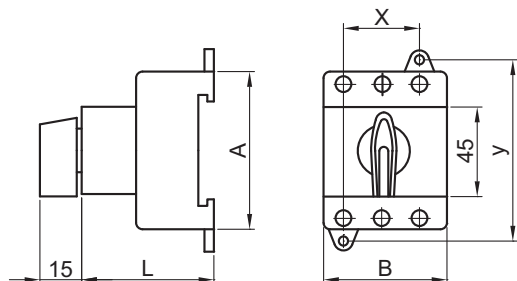

**RELEVANT STANDARD
EN 60947-3**

Se poate introduce în fereastra standard de 45 mm, poate fi fixat pe spate cu ajutorul a două șuruburi sau se montează pe șină omega 35/7,5 mm, conform EN 50022.

Zăvorîrea cu lacăt este posibilă numai în poziția „0” (OFF) a întreprupătorului









Întreprupător separator modular cu zăvorâre prin lacăt, tip EVOMS

TRACON	Ith (40 °C)
EVOMS16/3	16A/3P
EVOMS20/3	20A/3P
EVOMS25/3	25A/3P
EVOMS40/3	40A/3P
EVOMS80/3	80A/3P
EVOMS100/3	100A/3P
EVOMS125/3	125A/3P



F/21

Cutii

TRACON		W (mm)	H (mm)	D (mm)		IP..
TK/T3+F3/	 + 	112	108	78	2 × MG-25 2 × MG-32	IP 44
TK/T3+F3S/	 + 	112	108	78	2 × MG-25 2 × MG-32	IP 44
TKTS-03	 + 	140	109	200	2 × MG-25 2 × MG-32	IP 44

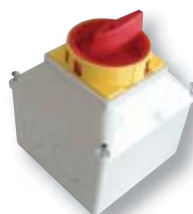
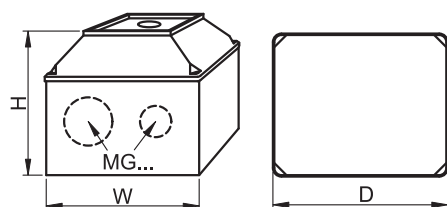

Garnituri

TRACON	
TKT-65/2	TS-20/3, TS-32/3, TS-40/3, TS-63/3, TS-20/4, TS-32/4, TS-40/4, TS-63/4
TKT-65/3	TSS-20/3, TSS-32/3, TSS-40/3, TSS-63/3, TSS-20/4, TSS-32/4, TSS-40/4, TSS-63/4

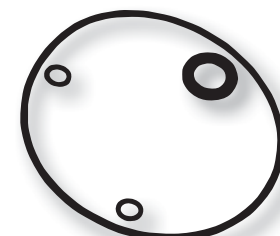

FAMILIA MODULARĂ DE PRODUSE EVO



**Siguranțe automate,
6 kA-10 kA**



F/12

**Siguranțe automate,
1+N**



F/15

**Disjunctoare cu pro-
tecție diferențială**



F/15

**Blocuri cu protecție
diferențială**



F/17

**Intrerupătoare sepa-
ratoare modulare**



F/19

**Selectoare
modulare**



F/20

**Întreprător separator mo-
dular cu zăvorâre prin lacăt**



F/21

**Lămpi de semnaliza-
re modulare**



F/21

**Butoane
modulare**

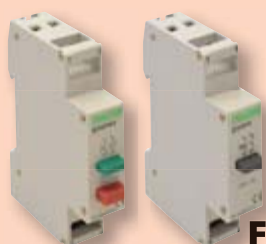

F/22

**Transformatoare de
siguranță (pt. sonerii)**



F/22

**Contactoare de
instalații**



F/23

**Relee de recuplare
automate**



F/24

Căutați noutățile în magazinul nostru virtual.

Înterupătoare manuale de curent continuu

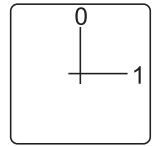
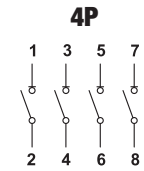

TRACON

In
1000 V DC

Pm

Icw
IEC 60947-3

KSDC-32

KSDC-32T

KSDC-32K

KSDC-32M

32 A

1.2-1.8

16 W

5 kA

1000 A

80 A

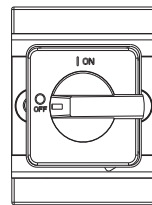
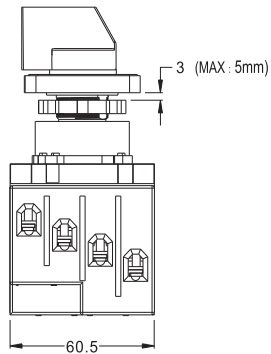
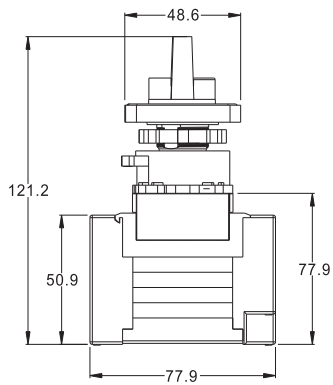

KSDC-..

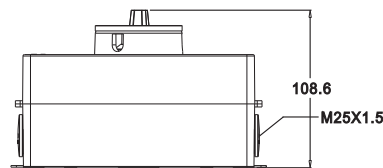
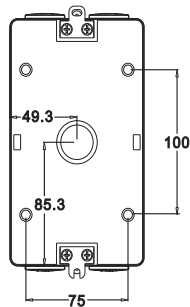
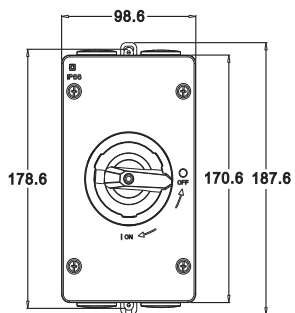

KSDC-..T

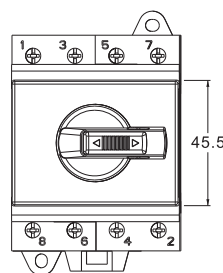
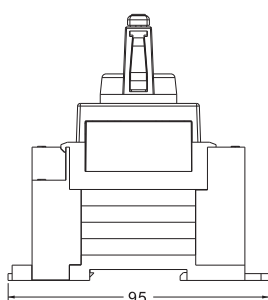
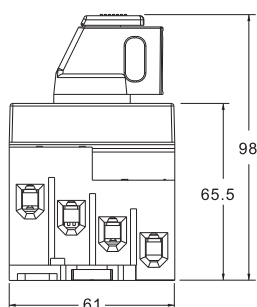
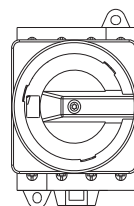
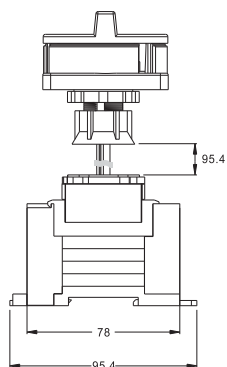
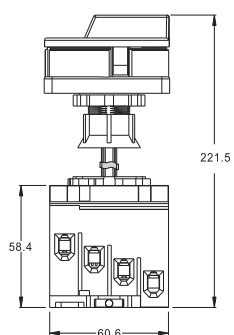

KSDC-..M





KSDC-..K

Contactoare

230/400 V AC	T _a -25...+55°C	max. ±30°	AC 1	AC 3	AC 4	AC 15	AC 6b
-----------------	-------------------------------	--------------	---------	---------	---------	----------	----------

 **Legendă pictograme** I/O

TRACON			
	TR1K..	TR1D..	TR1E..
U_m	AC-1, AC-3, AC-15 24 V AC, 48 V AC, 110 V AC, 230 V AC, 400 V AC	AC-1, AC-3, AC-4 24 V AC, 48 V AC, 110 V AC, 230 V AC, 400 V AC	AC-1, AC-3, AC-4 24 V AC, 48 V AC, 230 V AC, 400 V AC
I_e	6...12A/AC-3	9...95 A/AC-3	115...620 A/AC-3
			

Contactoarele se pot utiliza pentru acționarea , comutarea motoarelor sau altor instalații de joasă tensiune, singure sau echipate cu accesorii de protecție (ex: rele termice). Împreună cu senzori, se pot utiliza în aplicații de automatizare. Pe suprafața frontală al contactoarelor se pot monta contacte auxiliare și blocuri de temporizare, dar se pot echipa și cu contacte auxiliare laterale. Cu ajutorul lor se pot realiza acțiuni de semnalizare/blocare în circuite auxiliare. Aceste tipuri de contactoare se fabrică cu bobine de acționare în curent alternativ și sunt de 5 tipuri. Contactoarele se aleg în funcție de regim de lucru și categorie de utilizare (vezi Anexa).

Contactorul poate funcționa numai cu tensiune alternativă sinusoidală, lipsită de componentă de curent continuu. În cazul aplicațiilor în circuite electronice de comandă și reglaj, sau în cazul tensiunilor cu conținut ridicat de armonice, circuitul trebuie prevăzut cu filtre adecvate, încă înaintea punerii în funcțiune a contactorului.

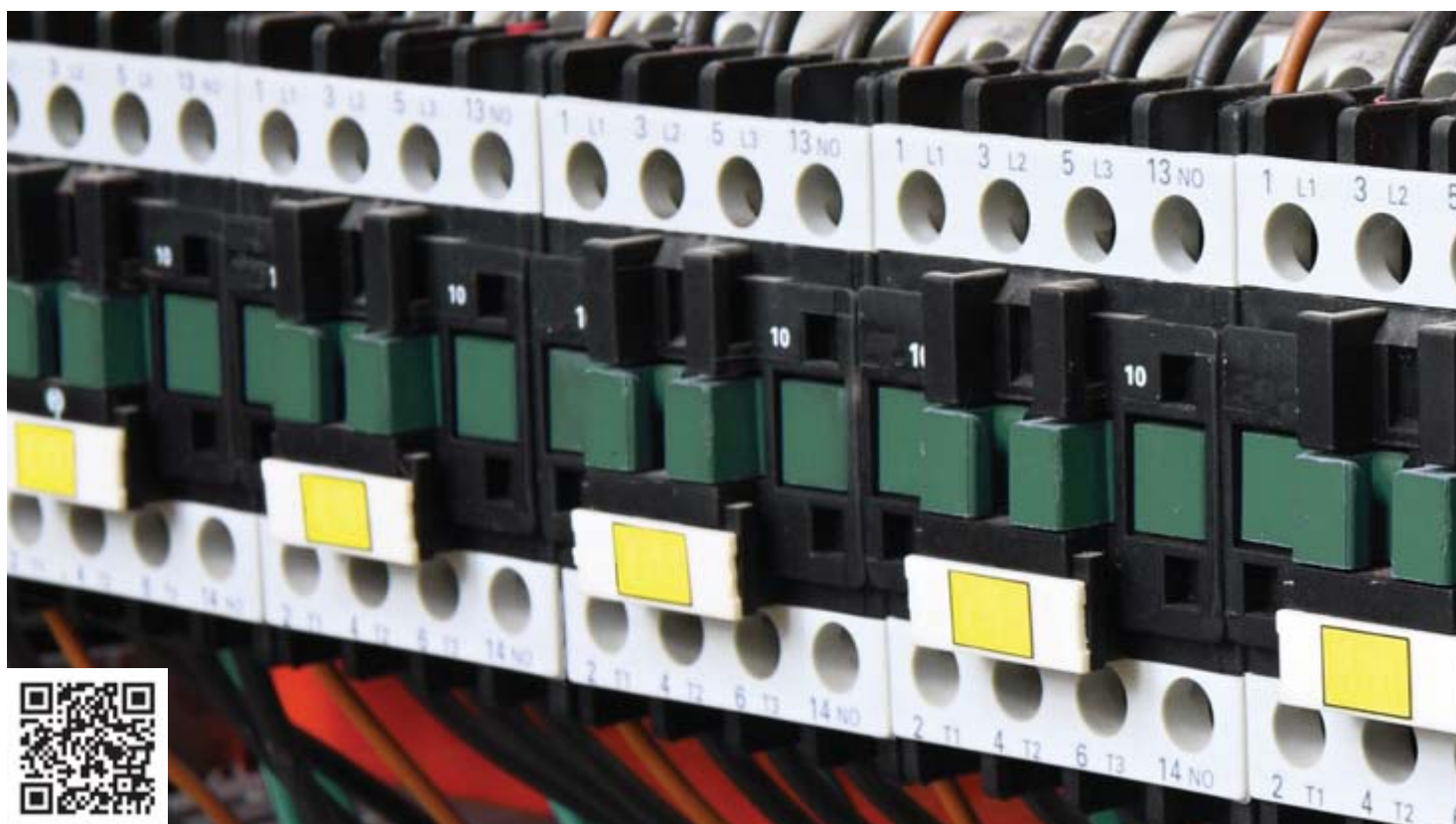

Contactoare auxiliare

230/400 V AC	U_i 690 V	U_e 660 V	I_{th} 20 A	ON-OFF-ON... sc/h x4.800	3×10^6	$\times 10^6$	$[mm^2]$ 1-4	P_{ON} 30 VA	P_{HOLD} 4,5 VA	35x7.5	T_a -25...+55°C	max. $\pm 30^\circ$	IP 20
-----------------	----------------	----------------	------------------	--------------------------------	-----------------	---------------	-----------------	-------------------	----------------------	--------	----------------------	---------------------	-----------------

	U_m	TRACON		
		6A/AC-3	9A/AC-3	12A/AC-3
	24 V~	-	TR1K0904B7	TR1K1204B7
	48 V~	-	TR1K0904E7	TR1K1204E7
	110 V~	-	TR1K0904F7	TR1K1204F7
	230 V~	-	TR1K0904	TR1K1204
	400 V~	-	TR1K0904V7	TR1K1204V7
	24 V~	TR1K0610B7	TR1K0910B7	TR1K1210B7
	48 V~	TR1K0610E7	TR1K0910E7	TR1K1210E7
	110 V~	TR1K0610F7	TR1K0910F7	TR1K1210F7
	230 V~	TR1K0610	TR1K0910	TR1K1210
	400 V~	TR1K0610V7	TR1K0910V7	TR1K1210V7
	24 V~	TR1K0601B7	TR1K0901B7	TR1K1201B7
	48 V~	TR1K0601E7	TR1K0901E7	TR1K1201E7
	110 V~	TR1K0601F7	TR1K0901F7	TR1K1201F7
	230 V~	TR1K0601	TR1K0901	TR1K1201
	400 V~	TR1K0601V7	TR1K0901V7	TR1K1201V7
	24 V~	-	TR1K0908B7	-
	48 V~	-	TR1K0908E7	-
	110 V~	-	TR1K0908F7	-
	230 V~	-	TR1K0908	-
	400 V~	-	TR1K0908V7	-
I_e (A)	AC-1	20	20	20
	AC-3	6	9	12
	AC15	2	3	4
P_e (kW)	220/230 V	AC-3	1,5	2,2
	380/400 V	AC-3	2,2	4
	415 V	AC-3	2,2	4
	500 V, 660/690 V	AC-3	3	4
		10 A aM	10 A aM	16 A aM

Desene cotate și găuri de fixare

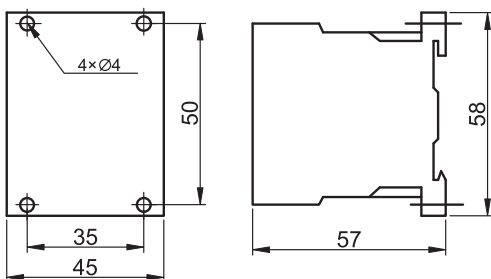

fixare pe placă de montaj;

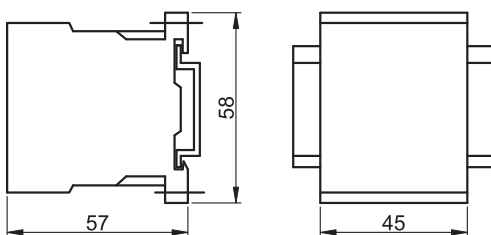

fixare pe șină de montaj (35x7,5 mm)



RELEVANT STANDARD
EN 60947-4-1

RELEVANT STANDARD
EN 60947-1

Contactoare de uz general de tip TR1D (9 A ... 32 A)

230/400 V AC	U_i 660 V	U_e 660 V	ON-OFF-ON... sc/h x3.600	3x10⁶	x10⁶	AUX (mm ²) 1-4	T_a -25...+55°C	max. ±30	IP 20	Legendă pictograme	I/O
-----------------	-------------------------------	-------------------------------	--------------------------------	-------------------------	------------------------	-------------------------------	-------------------------------------	-----------------	-----------------	---------------------------	------------

		TRACON					
		U _m	9A/AC-3	12A/AC-3	18A/AC-3	25A/AC-3	32A/AC-3
	24 V~		TR1D0910B7	TR1D1210B7	TR1D1810B7	TR1D2510B7	TR1D3210B7
	48 V~		TR1D0910E7	TR1D1210E7	TR1D1810E7	TR1D2510E7	TR1D3210E7
	110 V~		TR1D0910F7	TR1D1210F7	TR1D1810F7	TR1D2510F7	TR1D3210F7
	230 V~		TR1D0910	TR1D1210	TR1D1810	TR1D2510	TR1D3210
	400 V~		TR1D0910V7	TR1D1210V7	TR1D1810V7	TR1D2510V7	TR1D3210V7
	24 V~		TR1D0901B7	TR1D1201B7	TR1D1801B7	TR1D2501B7	TR1D3201B7
	48 V~		TR1D0901E7	TR1D1201E7	TR1D1801E7	TR1D2501E7	TR1D3201E7
	110 V~		TR1D0901F7	TR1D1201F7	TR1D1801F7	TR1D2501F7	TR1D3201F7
	230 V~		TR1D0901	TR1D1201	TR1D1801	TR1D2501	TR1D3201
	400 V~		TR1D0901V7	TR1D1201V7	TR1D1801V7	TR1D2501V7	TR1D3201V7
I_e (A)	AC-1		25	25	32	40	50
	AC-3		9	12	18	25	32
	AC-4		3,5	5	7,7	8,5	12
	220/230 V	AC-3	2,2	3	4	5,5	7,5
	380/400 V	AC-3	4	5,5	7,5	11	15
P_e (kW)	380/400 V	AC-4	4	2,5	3	3,7	4,5
	415 V	AC-3	4	5,5	9	11	15
	500 V, 660/690 V	AC-3	5,5	7,5	10	15	18,5
			10 A aM	16 A aM	20 A aM	32 A aM	40 A aM
mm ²		4	4	6	10	10	
		60 VA	60 VA	60 VA	90 VA	90 VA	
		7 VA	7 VA	7 VA	7,5 VA	7,5 VA	

Desene cotate și găuri de fixare

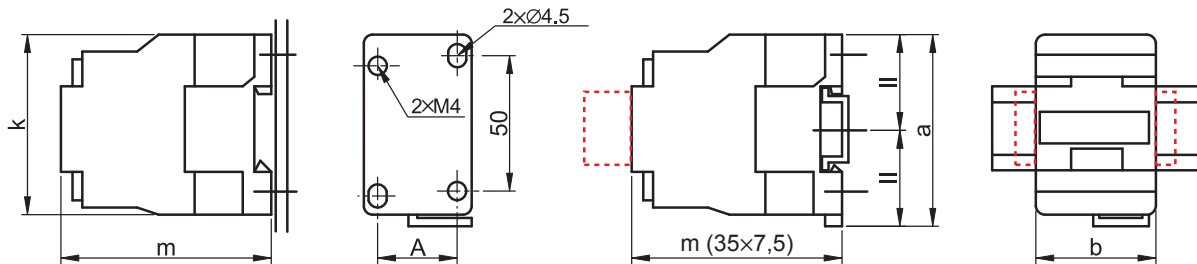

Fixare pe placă de montaj

Fixare pe șină de montaj



TRACON	TR1D09..	TR1D12..	TR1D18..	TR1D25..	TR1D32..
m (mm)	80	80	85	93	98
A (mm)	35	35	35	44	44
k (mm)	71	71	71	80	80
a (mm)	74	74	74	84	84
b (mm)	46	46	47	57	57
m (35x7,5)	82	82	87	95	100

Contactoare de uz general de tip TR1D (40 A ... 95 A)

230/400 V AC	U_i 660 V	U_e 660 V					T_a -25...+55°C		IP 20	
-----------------	-------------------------------	-------------------------------	--	--	--	--	-------------------------------------	--	-----------------	--

		TRACON					
		U _m	40A/AC-3	50A/AC-3	65A/AC-3	80A/AC-3	95A/AC-3
		24 V~	TR1D4011B7	TR1D5011B7	TR1D6511B7	TR1D8011B7	TR1D9511B7
		48 V~	TR1D4011E7	TR1D5011E7	TR1D6511E7	TR1D8011E7	TR1D9511E7
		110 V~	TR1D4011F7	TR1D5011F7	TR1D6511F7	TR1D8011F7	TR1D9511F7
		230 V~	TR1D4011	TR1D5011	TR1D6511	TR1D8011	TR1D9511
		400 V~	TR1D4011V7	TR1D5011V7	TR1D6511V7	TR1D8011V7	TR1D9511V7
		I_e (A)	AC-1	60	80	80	125
	AC-3	40	50	65	80	95	
	AC-4	18,5	24	28	37	44	
P_e (kW)	220/230 V	AC-3	11	15	18,5	22	25
	380/400 V	AC-3	18,5	22	30	37	45
	380/400 V	AC-4	5,5	7,5	9	10	15
	415 V	AC-3	22	25	37	45	45
	500 V	AC-3	22	30	37	55	55
	660/690 V	AC-3	30	33	37	45	45
	1000 V	AC-3	-	30	37	45	45
			50 A aM	50 A aM	63 A aM	80 A aM	100 A aM
mm ²			25	25	25	50	50
			200 VA	200 VA	200 VA	200 VA	200 VA
			20 VA	20 VA	20 VA	20 VA	20 VA

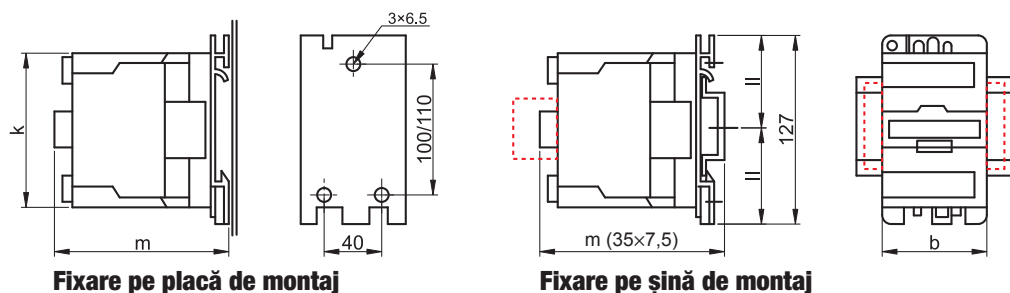

Desene cotate și găuri de fixare



TRACON	TR1D40..	TR1D50..	TR1D65..	TR1D80..	TR1D95..
m (mm)	114	114	114	125	125
k (mm)	107	107	107	123	123
b (mm)	75	75	75	85	85
m (35x7,5)	116	116	116	127	127



TEMS - Combinații de întrerupătoare de protecție pentru motoare, montate în carcasă

TRACON	Pe (kW), AC-3*	Ie (A), AC-3*	Um			
TEMS1-091	1,5	3,5	400 V~	9 A / AC-3	2,5 – 4 A	6 A aM
TEMS1-092	2,2	5	400 V~	9 A / AC-3	4 – 6 A	10 A aM
TEMS1-093	3	6,3	400 V~	9 A / AC-3	5,5 – 8 A	10 A aM
TEMS1-094	4	8,5	400 V~	9 A / AC-3	7 – 10 A	16 A aM
TEMS1-121	5	11,5	400 V~	12 A / AC-3	9 – 13 A	16 A aM
TEMS1-181	7,5	15,5	400 V~	18 A / AC-3	12 – 18 A	20 A aM
TEMS2-251	11	22	400 V~	25 A / AC-3	17 – 25 A	25 A aM
TEMS2-321	15	30	400 V~	32 A / AC-3	23 – 32 A	40 A aM
TEMS3-401	18,5	37	400 V~	40 A / AC-3	30 – 40 A	40 A aM
TEMS3-501	22	44	400 V~	50 A / AC-3	37 – 50 A	63 A aM
TEMS3-651	25	57	400 V~	65 A / AC-3	48 – 65 A	80 A aM
TEMS3-801	37	72,5	400 V~	80 A / AC-3	55 – 70 A	80 A aM
TEMS3-802	37	72,5	400 V~	80 A / AC-3	63 – 80 A	80 A aM
TEMS3-951	45	85	400 V~	95 A / AC-3	80 – 93 A	100 A aM

* Datele se referă la un motor trifazic cu rotorul în colivie, ce funcționează în conexiunea triunghi (delta).

Echipamentul este format din următoarele: un contactor de comandă, un releu termic de protecție la supracurent, un buton verde de CONECTARE, un buton roșu de DECONNECTARE, dintr-o carcasă din plastic – formată din două părți sau dintr-o carcasă din tablă de oțel. Parametrii tehnici ai contactorului și ai releului de protecție la supracurent determină puterea motorului care poate fi acționat de această combinație. Cu releul termic de protecție la supracurent se poate regla nivelul protecției de curent, corespunzător parametrilor tehnici ai motorului. Cu ajutorul butoanelor CONECTARE/DECONNECTARE se poate realiza conectarea și deconectarea motorului. Dacă motorul se oprește din cauza funcționării releului termic, atunci trebuie apăsat butonul DECONNECTARE, înainte de reconectare, pentru a se realiza deblocarea! Carcasa se poate monta simplu pe suprafață cu ajutorul găurilor de fixare aflate pe spatele acesteia. Introducerea cablurilor este ușurată de orificiile – decupabile prin lovire - practicate în partea superioară, inferioară și posterioară a carcasei. Echipamentul este gata de funcționare după conectarea cablurilor. Echipamentele trebuiesc prevăzute cu protecție externă la scurtcircuit!

Tipodimensiunile si datele tehnice ale TEMS1

400
V AC

 U_i
660 V

 3x10⁵

 x10⁶

T_a 
0..+55 °C

IP
55



Legendă pictograme

I/O



TRACON	TEMS1-091	TEMS1-092	TEMS1-093	TEMS1-094	TEMS1-121	TEMS1-181	
Ie (A), AC-3	400 V 660 V	3,5 2,7	5 3,8	6,3 4,8	8,5 6,6	11,5 8,9	15,5 12
I_{th} (A)	400 V	25	25	25	25	25	32
Pe (kW), AC-3	400 V 660 V	1,5 5,5	2,2 5,5	3 5,5	4 5,5	5,5 7,5	7,5 10
I_{th} (A)	AUX	6	6	6	6	6	6
P_m (VA)	AC-15 DC-13	300 30	300 30	300 30	300 30	300 30	300 30

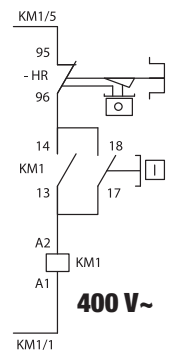
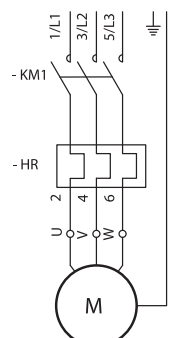
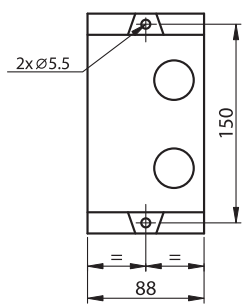
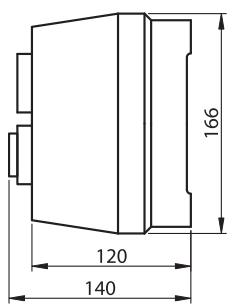

Pentru introducerea cablurilor de alimentare s-au prevăzut 2 orificii, ușor decupabile, în partea de sus a carcasei inferioare din plastic, corespunzătoare pentru presetupele Pg 13,5, iar în partea din jos a carcasei, pentru o presetupă Pg 16 și una Pg 13,5

Tipodimensiunile si datele tehnice ale TEMS2

400 V AC	660 V			T_a 0..+55 °C	IP 55
-----------------	--------------	--	--	---------------------------------------	--------------



Legendă pictograme I/O

TRACON	TEMS2-251	TEMS2-321	
I_e (A), AC-3	400 V 660 V	22 18	30 21,3
I_{th} (A)	400 V	40	50
P_e (kW), AC-3	400 V 660 V	11 15	15 18,5
I_{th} (A)		6	6
P_m (VA)	AC-15	300	300
	DC-13	30	30

RELEVANT STANDARD
EN 60529

RELEVANT STANDARD
EN 60695-2-1

RELEVANT STANDARD
EN 60439



Pentru introducerea cablurilor de alimentare s-au prevăzut 2 orificii, ușor decupabile, în partea de sus a carcasei inferioare din plastic, corespunzătoare pentru presetupele Pg-16, iar în partea din jos pentru o presetupă Pg-16 și una Pg-13,5.

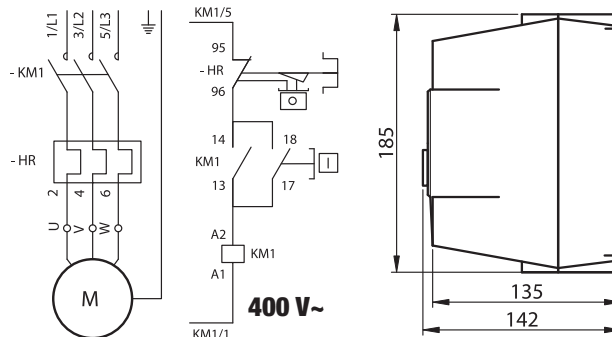

Tipodimensiunile si datele tehnice ale TEMS3

400 V AC	660 V			T_a 0..+55 °C	IP 55
-----------------	--------------	--	--	---------------------------------------	--------------

Legendă pictograme I/O



TRACON	TEMS3-401	TEMS3-501	TEMS3-651	TEMS3-801	TEMS3-951	
I_e (A), AC-3	400 V 660 V	37 34,6	44 39	60 42	72,5 49	85 49
I_{th} (A)	400 V	60	80	80	125	125
P_e (kW), AC-3	400 V 660 V	18,5 30	22 33	30 37	37 45	45 55
I_{th} (A)		6	6	6	6	6
P_m (VA)	AC-15	300	300	300	300	300
	DC-13	30	30	30	30	30



Pe contactorul variantei de execuție cu carcasă din metal se află un contact auxiliar normal închis, care se poate utiliza pentru semnalizări și comenzi ulterioare. Pentru introducerea cablurilor de alimentare, în partea de sus a carcasei inferioare s-a prevăzut un orificiu corespunzător presetupeii Pg 29 și unul corespunzător presetupeii Pg 13,5, iar în partea de jos a carcasei 2 buc. pentru Pg 29 și 1 buc. pentru Pg 13,5. Orificiile sunt prevăzute cu dopuri. Carcasa metalică este clasa I de protecție la atingere și înainte de punerea în funcțiune acesta trebuie legată la pământ.

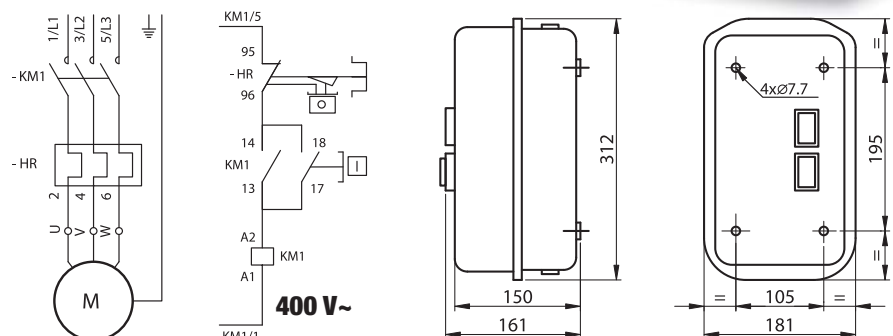

Contactoare pentru curenți mari

400 V AC	U_i 660 V	U_e 660 V	AUX (mm²) 1-4	T_a -25...+55°C	max. ±30°	IP 20
-----------------	-------------------------------	-------------------------------	------------------------------------	-------------------------------------	------------------	-----------------



		TRACON			
		U _m	115A/AC-3	150A/AC-3	170A/AC-3
		24 V~	TR1E115B7	TR1E150B7	TR1E170B7
		48 V~	TR1E115E7	TR1E150E7	TR1E170E7
		230 V~	TR1E115	TR1E150	TR1E170
		400 V~	TR1E115V7	TR1E150V7	TR1E170V7
I_e (A)	AC-1	250	250	250	
	AC-3	115	150	170	
P_e (kW)	AC-4	40	50	60	
	220/230 V	30	40	55	
	380/400 V	55	75	90	
	415 V	59	80	100	
	500 V	75	90	110	
	660/690 V	80	100	110	
		1000 V	65	65	100
		mm ²	95	120	150
		ON-OFF-ON... sc/h	× 1800	× 1800	× 1800
		(× 10 ⁵)	30 / 6	30 / 6	30 / 6
		P_{ON} / P_{HOLD} (VA)	550 / 45	550 / 45	805 / 55

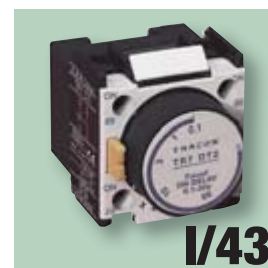

		TRACON						
		U _m	205A/AC-3	245A/AC-3	300A/AC-3	410A/AC-3	475A/AC-3	620A/AC-3
		24 V~	TR1E205B7	TR1E245B7	TR1E300B7	TR1E410B7	TR1E475B7	TR1E620B7
		48 V~	TR1E205E7	TR1E245E7	TR1E300E7	TR1E410E7	TR1E475E7	TR1E620E7
		230 V~	TR1E205	TR1E245	TR1E300	TR1E410	TR1E475	TR1E620
		400 V~	TR1E205V7	TR1E245V7	TR1E300V7	TR1E410V7	TR1E475V7	TR1E620V7
I_e (A)	AC-1	275	315	400	500	700	1000	
	AC-3	205	245	300	410	475	620	
P_e (kW)	AC-4	70	80	100	140	160	210	
	220/230 V	63	75	100	110	147	200	
	380/400 V	110	132	160	200	250	335	
	415 V	110	132	180	220	280	375	
	500 V	129	160	200	257	355	400	
	660/690 V	129	160	220	280	335	450	
		1000 V	100	147	160	185	335	450
		mm ²	185	240	240	2×150	2×240	2×60×5
		ON-OFF-ON... sc/h	× 1800	× 1800	× 1800	× 900	× 900	× 900
		(× 10 ⁵)	30 / 5	30 / 5	30 / 5	10 / 3	10 / 3	10 / 2
		P_{ON} / P_{HOLD} (VA)	805 / 55	700 / 8	700 / 8	1150 / 12	1150 / 16	1730 / 20

Protecția contactoarelor de tip TR1E împotriva suprasarcinii vezi pag. I/47!

Desene cotate

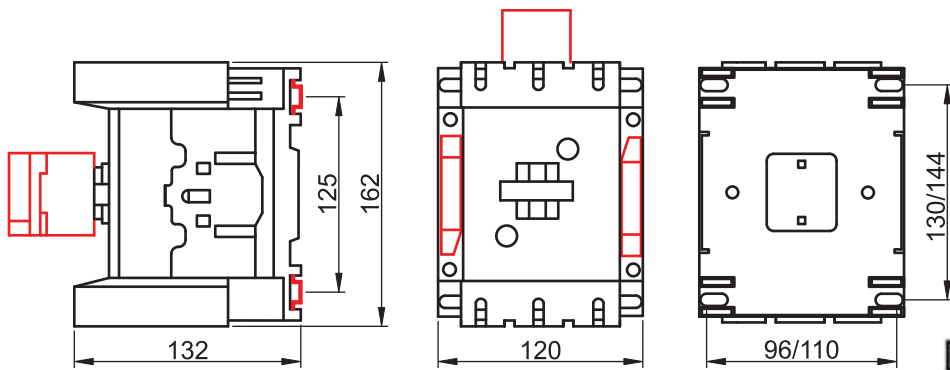

TR1E115 ... TR1E170

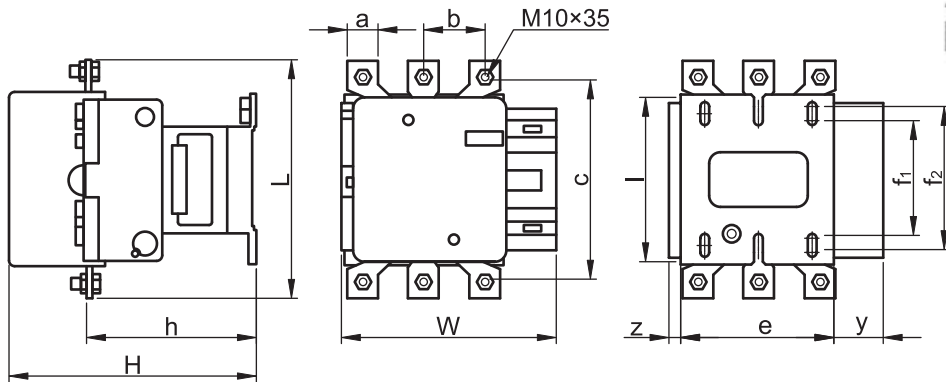

TR1E205 ... TR1E300

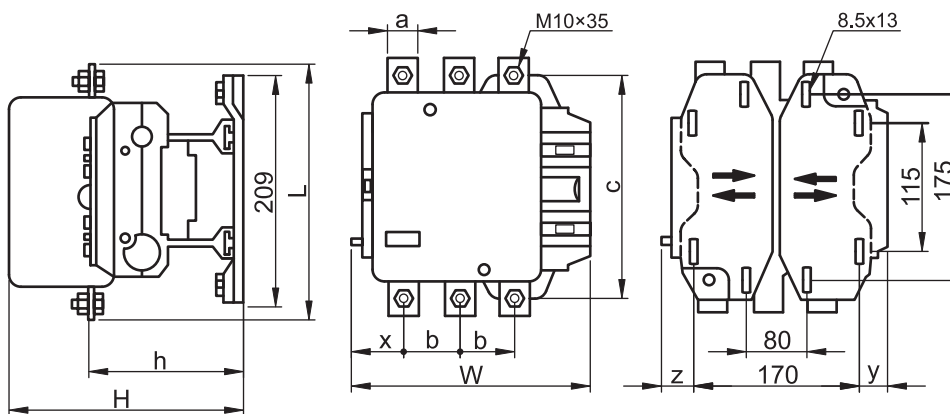

TR1E410, TR1E475

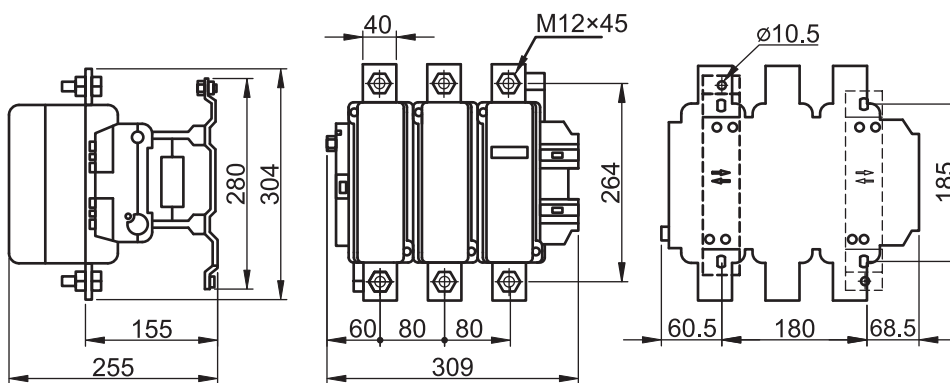

TR1E620



TRACON	W (mm)	H (mm)	L (mm)	a (mm)	b (mm)	c (mm)	l (mm)	e (mm)	x (mm)	f1 (mm)	f2 (mm)	h (mm)	y (mm)	z (mm)
TR1E205	170	181	175	20	40	156	137	80	-	106	120	114	44	15
TR1E245	170	182	196	25	48	172	137	80	-	106	120	113	44	15
TR1E300	215	217	205	25	48	180	145	96	-	110	122	145	38	20,5
TR1E410	215	222	205	25	48	180	-	-	45	-	-	148	23,5	15
TR1E475	235	225	235	30	55	210	-	-	43	-	-	140	44	15

Contacte auxiliare

U_i 690 V	U_e 660 V	I_{th} 10 A	I_e 2 A	$\times 10^7$	ON-OFF-ON... sc/h $\times 3.600$	AC 15	[mm ²] 1x1-2x2,5	10 A Gg	T_a -25...+50°C	IP 20
-------------------------------	-------------------------------	-------------------------------	-----------------------------	---------------	--	-----------------	---------------------------------	---------	-------------------------------------	-----------------

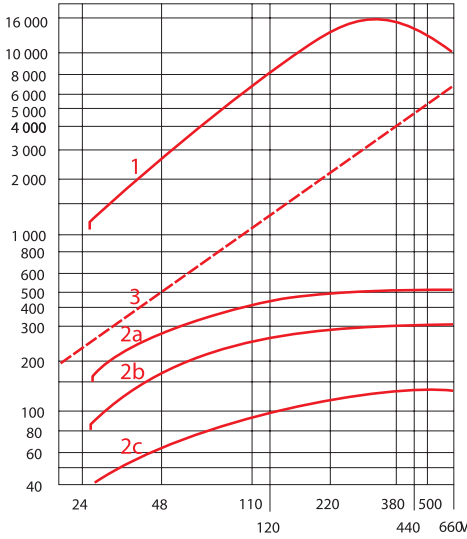

Durata de viață electrică în funcție de puterea comandată (AC15)

	U _e						
	24 V	48 V	110 V 127 V	220 V 230 V	380 V 400 V	440 V	600 V
10⁶	150 VA	300 VA	400 VA	480 VA	500 VA	500 VA	500 VA
3×10⁶	80 VA	170 VA	250 VA	290 VA	320 VA	320 VA	320 VA
10⁷	30 VA	65 VA	90 VA	120 VA	130 VA	130 VA	130 VA

Legendă:

- 1: limita capacității de rupere
- 2a: 10⁶ cicluri de funcționare
- 2b: 3×10⁶ cicluri de funcționare
- 2c: 10⁷ cicluri de funcționare
- 3: limită încălzire

Contacte auxiliare frontale

Pentru contactoare auxiliare TR1K

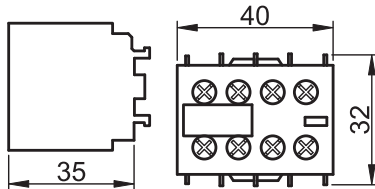

TRACON



TR5KN02	2 × NC
TR5KN04	4 × NC
TR5KN11	1 × NO + 1 × NC
TR5KN13	1 × NO + 3 × NC
TR5KN20	2 × NO
TR5KN22	2 × NO + 2 × NC
TR5KN31	3 × NO + 1 × NC
TR5KN40	4 × NO



Pentru contactoare TR1D și TR1E

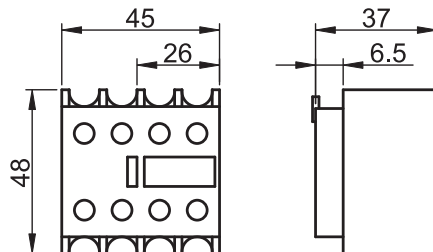
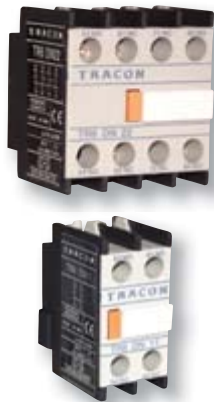

TRACON





TR6DN02	2 × NC
TR6DN04	4 × NC
TR6DN11	1 × NO + 1 × NC
TR6DN13	1 × NO + 3 × NC
TR6DN20	2 × NO
TR6DN22	2 × NO + 2 × NC
TR6DN31	3 × NO + 1 × NC
TR6DN40	4 × NO





TR6-DN40 TR5-KN40	TR6-DN31 TR5-KN31	TR6-DN22 TR5-KN22	TR6-DN13 TR5-KN13	TR6-DN04 TR5-KN04	TR6-DN20 TR5-KN20	TR6-DN11 TR5-KN11	TR6-DN02 TR5-KN02



TR8... contact auxiliar lateral pentru contactoarele TR1D09... -TR1D65..., și TR1E115..170

TRACON

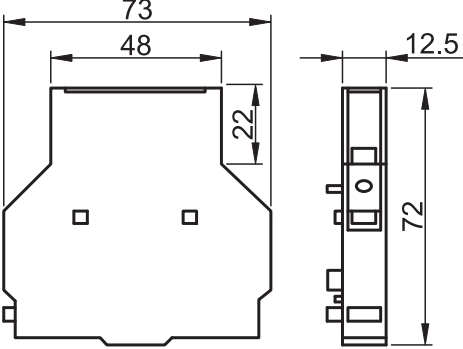
 NC
 NO

TR8-DN20	2 × NO
TR8-DN11	1 × NC + 1 × NO

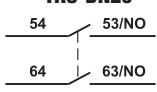
TR8-DN20	
TR8-DN11	





TR8-DN20

TR8-DN11



TR7... blocuri de temporizare pentru contactoare TR1D/E...

TRACON

 NC
 NO

 on t_{off}

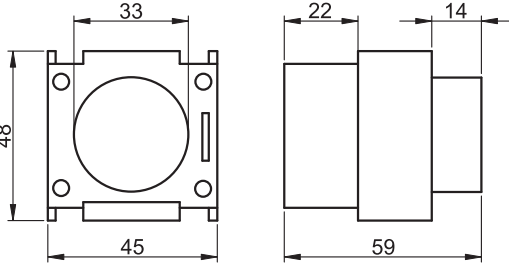
TR7DT2	1 × NC + 1 × NO	0.1-30 s
TR7DR2	1 × NC + 1 × NO	0.1-30 s



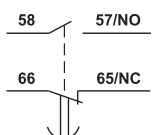
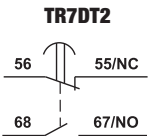

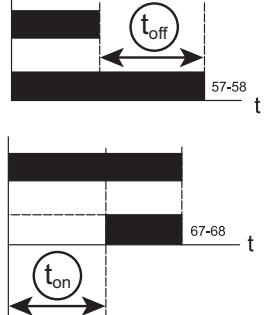
TR7DR2	
TR7DT2	





Blocaje mecanice

TRACON



TR9-D09978	9-32 A
TR9-D50978	40-95 A

Intercalate între două contactoare, împiedică conectare simultană a acestora. Pot fi aplicate în schimbătoare de sens fără blocaj electric, precum și în sisteme de conectare stea-triunghi.

TR9-D09978

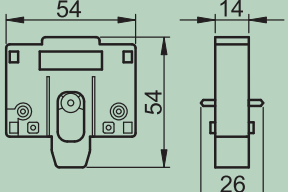

Între 9 – 32 A, legătura stabilă între cele două comutatoare magnetice se asigură cu distanțiere introduse în lăcășele de ancoraj amplasate în părțile laterale ale contactoarelor.

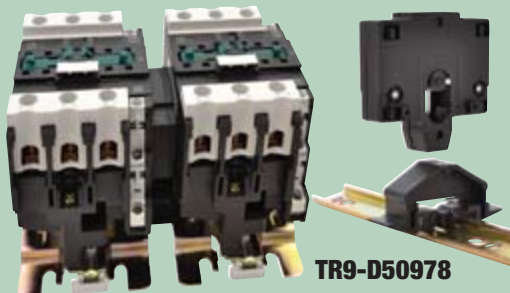

TR9-D50978

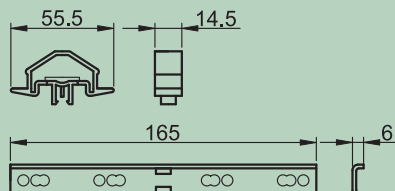

Între 40 – 95 A, legătura fiabilă între cele două comutatoare magnetice se asigură cu șină auxiliară fixată cu șuruburi pe plăcile de montaj din baza comutatoarelor magnetice, și distanțiere aplicate pe șină.

Relee termice de protecție

Datele electrice ale circuitului de comandă

U_i 690 V	U_{imp} 6 kV	50/60 Hz 	I_{th} 6 A	I_e 2 A	AC 15	$[mm^2]$ 1-2,5
----------------	-------------------	--------------	-----------------	--------------	----------	-------------------

Legendă pictograme I/O

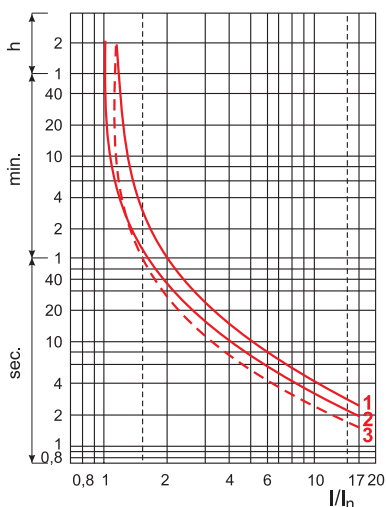

	U_e				
	24 V	48 V	110 V	230 V	400 V
P_e	100 VA	200 VA	400 VA	600 VA	600 VA

- Legendă:**
- 1: sarcină tripolară cu pornire la rece
 - 2: sarcină bipolară cu pornire la rece
 - 3: sarcină tripolară de durată cu pornire la cald

Se folosesc pentru protejarea motoarelor electrice de posibilele defecțiuni cauzate de curenții mari datorate suprasolicității motorului electric. Curba caracteristică a releului este inversă; cu cât valoarea curentului din circuitul motorului este mai mare, cu atât decuplează mai rapid. Bornele din cupru cu secțiune circulară ale releului se conectează la bornele 2T1; 4T2 și 6T3 ale contactorului.

Setarea releului se face cu reglajele de pe partea frontală acoperită cu un material transparent care se poate plomba dacă este cazul. Tot aici se găsește și butonul TEST pentru testarea circuitului. Butonul STOP (de culoare roșie) este plasat deasupra capacului transparent. Releul are două contacte: unul normal închis și unul normal deschis independent electric de primul, și un indicator optic pentru a semnala starea de oprit.

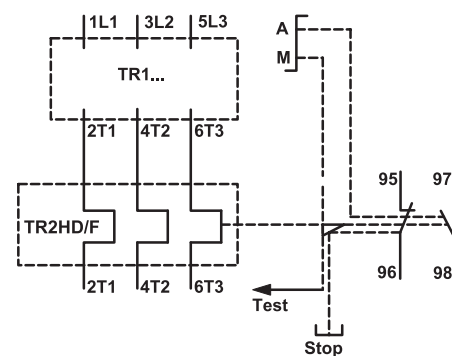

A: revenire automată
M: revenire manuală

Pentru contactor TR1K

U_i 690 V	U_{imp} 6 kV	0-400 Hz 	T_a -30...+55°C	IP 20	Class Ir 10A
----------------	-------------------	--------------	----------------------	----------	-----------------

Legendă pictograme I/O

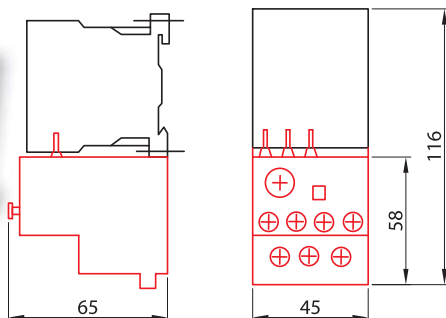

TRACON	I_{th}	$[mm^2]$	
TR2HK0301	0.1 – 0.16 A		
TR2HK0302	0.16 – 0.25 A		
TR2HK0303	0.25 – 0.4 A		
TR2HK0304	0.4 – 0.63 A		
TR2HK0305	0.63 – 1 A		
TR2HK0306	1 – 1.6 A	1.5 – 4	
TR2HK0307	1.6 – 2.5 A		
TR2HK0308	2.5 – 4 A		
TR2HK0310	4 – 6 A		
TR2HK0312	5.5 – 8 A		
TR2HK0314	7 – 10 A		
TR2HK0316	9 – 13 A		



Pentru contactor TR1D

TRACON	I _{th}	mm ²
TR2HD1304	0,4 – 0,63 A	2.5 – 10
TR2HD1305	0,63 – 1 A	
TR2HD1306	1 – 1,6 A	
TR2HD1307	1,6 – 2,5 A	
TR2HD1308	2,5 – 4 A	
TR2HD1310	4 – 6 A	
TR2HD1312	5,5 – 8 A	
TR2HD1314	7 – 10 A	
TR2HD1316	9 – 13 A	
TR2HD1321	12 – 18 A	
TR2HD1322	17 – 25 A	
TR2HF2353	23 – 32 A	
TR2HF2355	28 – 36 A	
TR2HD3353	23 – 32 A	
TR2HD3355	30 – 40 A	
TR2HD3357	37 – 50 A	
TR2HD3359	48 – 65 A	
TR2HD3361	55 – 70 A	
TR2HD3363	63 – 80 A	
TR2HD3365	80 – 93 A	

U_i
690 V

U_{imp}
6 kV

0-400 Hz

T_a
-30...+55°C

IP
20

Class Ir
10A

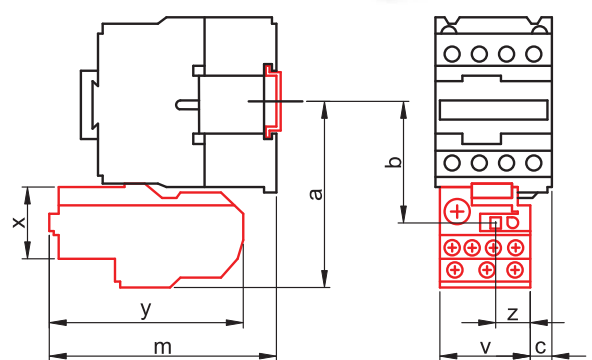
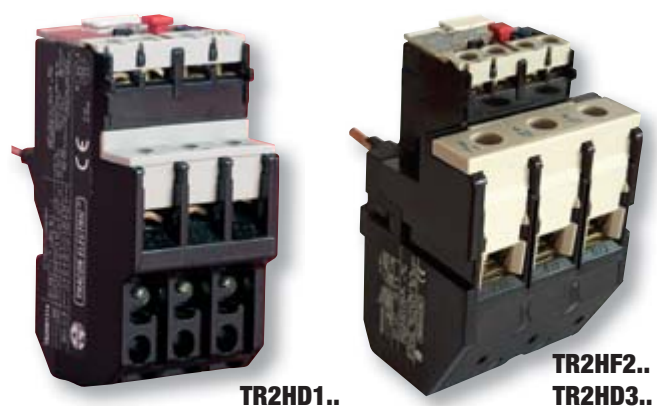

TRACON	a (mm)	b (mm)	c (mm)	m (mm)	x (mm)	y (mm)	v (mm)	z (mm)
TR1D09...D18	81	50	0	98	47	92	44	17
TR1D25	86	55	10.7	108	47	92	44	17
TR1D32	86	55	8.1	109	47	92	44	17
TR1D40...D65	111	72.4	4.5	119	54	109	70	30
TR1D80...D95	115.5	76.9	9.5	124	54	109	70	30

Adaptor pentru rele termice

TRACON	H	L	W
TR2AD1	TR2HD13..	46x78x86	
TR2AD3	TR2HF23.., TR2HD33..	73x103x120	

RELEVANT STANDARD
EN 60947-1

RELEVANT STANDARD
EN 60947-4-1

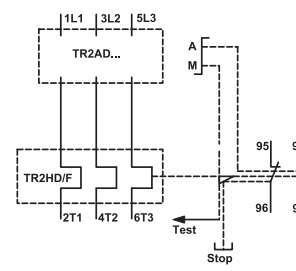

A: revenire automată
M: revenire manuală

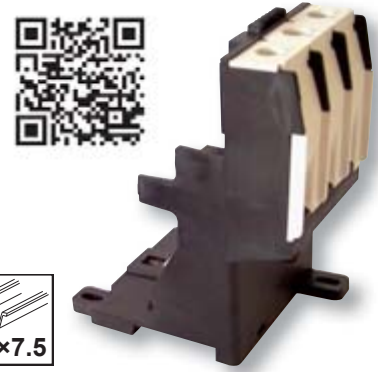
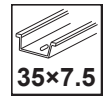

Contactoare de instalații, tip EVOHK





F/23



Corelarea contactoarelor și releelor termice

Tabelele de mai jos servesc selectării respectiv corelării contactorului și releului termic pe baza datelor tehnice a motorului de protejat. Valoarea puterii și curentului din tabel se referă la funcționarea motorului trifazic în conexiune triunghi. Regim de utilizare: AC-3.

Exemple de corelare a contactorului de tip TR1K cu releul termic de protecție:

Pe (kW)	Ie (A)			I _{th}		
					aM	gG (gL)
-	0,1	TR1K06	TR2HK0301	0,1 – 0,16	1	2
0,06	0,16	TR1K06	TR2HK0302	0,16 – 0,25	1	2
0,08	0,25	TR1K06	TR2HK0303	0,25 – 0,4	1	2
0,1	0,4	TR1K06	TR2HK0304	0,4 – 0,63	2	4
0,3	1,0	TR1K06	TR2HK0305	0,63 – 1	2	4
0,4	1,0	TR1K06	TR2HK0306	1 – 1,6	2	4
0,8	2,0	TR1K06	TR2HK0307	1,6 – 2,5	4	6
1,1	2,6	TR1K06	TR2HK0308	2,5 – 4	6	10
1,5	3,5	TR1K06	TR2HK0308	2,5 – 4	6	10
2,2	5,0	TR1K06	TR2HK0310	4 – 6	10	16
3,0	6,3	TR1K06	TR2HK0312	5,5 – 8	10	16
4,0	8,5	TR1K09	TR2HK0314	7 – 10	10	20
5,0	11	TR1K12	TR2HK0316	9 – 13	16	25

Exemple de corelare a contactorului de tip TR1D cu releul termic de protecție:

Pe (kW)	Ie (A)			I _{th}		
					aM	gG (gL)
0,1	0,4	TR1D09	TR2HD1304	0,4-0,63	2	4
0,3	1,0	TR1D09	TR2HD1305	0,63-1	2	4
0,4	1,0	TR1D09	TR2HD1306	1-1,6	2	4
0,8	2,0	TR1D09	TR2HD1307	1,6-2,5	4	6
1,1	2,6	TR1D09	TR2HD1308	2,5-4,0	6	10
1,5	3,5	TR1D09	TR2HD1308	2,5-4,0	6	10
2,2	5,0	TR1D09	TR2HD1310	4,0-6,0	10	16
3,0	6,3	TR1D09	TR2HD1312	5,5-8	10	16
4,0	8,5	TR1D09	TR2HD1314	7,0-10,0	10	20
5,0	11,0	TR1D12	TR2HD1316	9-13,0	16	25
7,5	15,5	TR1D18	TR2HD1321	12,0-18,0	20	35
9,0	18,0	TR1D18	TR2HD1321	12,0-18,0	25	35
11,0	22,0	TR1D25	TR2HD1322	17,0-25,0	25	50
15,0	30,0	TR1D40	TR2HD3353	23,0-32,0	40	63
18,0	40,0	TR1D40	TR2HD3355	30-40,0	50	63
22,0	44,0	TR1D50	TR2HD3357	37,0-50,0	63	80
25,0	57,0	TR1D65	TR2HD3359	48-65,0	80	100
30,0	60,0	TR1D65	TR2HD3361	55,0-70,0	80	100
37,0	72,0	TR1D80	TR2HD3363	63,0-80,0	80	125
45,0	93,0	TR1D95	TR2HD3365	80-93,0	100	125

Pornirea motoarelor

Cu ajutorul contactoarelor, contactelor auxiliare, releelor de protecție și al temporizatoarelor se pot realiza mai multe sisteme de pornire a motoarelor. Unul dintre aceste sisteme este cel stea-triunghi. Sistemul de pornire stea-triunghi necesită 3 contactoare, 2 contacte auxiliare, 1 bloc de temporizare și 1 releu termic. Scurta prezentare din anexă vă oferă ajutor pentru alegerea produselor necesare, proiectarea traseelor și realizarea conexiunilor.

Protecția instalațiilor electrice, comandate de contactoare de curent mare, împotriva suprasarcinii.

Protecția fiabilă împotriva suprasarcinii a instalațiilor electrice industriale, comandate de contactoare de curent mare, se realizează de regulă în mod indirect, cu așa-numitele combinații de protecție. Elementele de detectare-comandă ale combinației, sunt rele de protecție sensibile la creșterea curentului, reglabile în domeniul 0 – 5 A, montate pe fiecare fază, intrarea cărora se conectează la bobina secundară a reductorului de curent aplicat pe faza respectivă. Dacă contactele auxiliare ale releelor sunt legate în serie, și curentul în oricare dintre faze depășește valoarea reglată, releul din faza respectivă se excită, și deschide circuitul de comandă al contactorului de curent mare, realizând astfel protecția instalației. De notat, că această soluție nu urmărește curba caracteristică standard a protecției motoarelor.

Repartizarea bornelor de contact:

L,N	Tensiune de alimentare
k;l	Contactele reductorului de curent
1	NO contact normal deschis
2	CO contact comun
3	NC contact normal închis



Elementele protecției

TRACON	Denumire	număr necesar	Pagina
TFKV-AKA05	releu de protecție sensibil la creșterea curentului	3 buc. (1 buc./fază)	J/25
AV, AVBS	reductor de curent de joasă tensiune, curent secundar 5A	3 buc. (1 buc./fază)	L/26

Note:

- Protecția nu se activează la vârfuri de curent, datorate pornirii motorului, în intervale de timp reglabile între 0,5-8 s.
- Dacă valoarea curentului diferă de cea reglată, la sfârșitul intervalului de timp reglat, ieșirea releului își schimbă starea.
- Ieșirea releului nu-și schimbă starea, dacă în domeniul de timp (0,5 – 15 s) reglat valoarea curentului secundar al reductorului de curent revine la valoarea reglată pentru protecție.

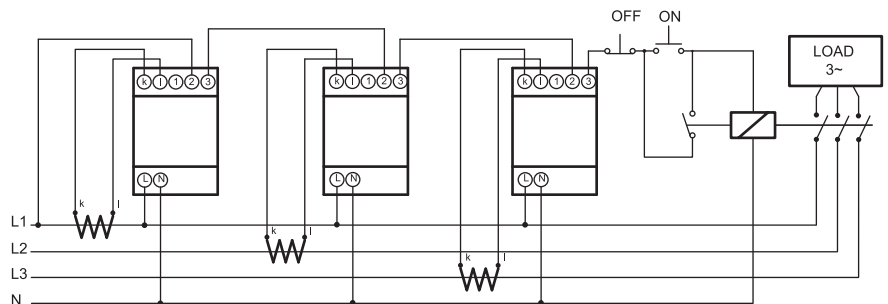

- Domeniile de timp ale releelor de protecție aplicate pe faze trebuie reglate la aceeași valoare!

n	TRACON	I _{th} min	I _{th} max	I _{reg} (A)					
				0,5	1	2	3	4	5
-	-	0,5 A	5 A	0,5 A	1 A	2 A	3 A	4 A	5 A
100/5A	TR1E115	10 A	100 A	10 A	20	40	60	80	100 A
120/5A	TR1E115	12 A	120 A	12 A	24	48	72	96	120 A
125/5A	TR1E150	12,5 A	125 A	12,5 A	25	50	75	100	125 A
150/5A	TR1E170	15 A	150 A	15 A	30	60	90	120	150 A
200/5A	TR1E205	20 A	200 A	20 A	40	80	120	160	200 A
250/5A	TR1E245	25 A	250 A	25 A	50	100	150	200	250 A
300/5A	TR1E300	30 A	300 A	30 A	60	120	180	240	300 A
400/5A	TR1E410	40 A	400 A	40 A	80	160	240	320	400 A
500/5A	TR1E475	50 A	500 A	50 A	100	200	300	400	500 A
600/5A	TR1E620	60 A	600 A	60 A	120	240	360	480	600 A
750/5A	-	75 A	750 A	75 A	150	300	450	600	750 A
800/5A	-	80 A	800 A	80 A	160	320	480	640	800 A
1000/5A	-	100 A	1000 A	100 A	200	400	600	800	1000 A
1500/5A	-	150 A	1500 A	150 A	300	600	900	1200	1500 A
2000/5A	-	200 A	2000 A	200 A	400	800	1200	1600	2000 A
2500/5A	-	250 A	2500 A	250 A	500	1000	1500	2000	2500 A
3000/5A	-	300 A	3000 A	300 A	600	1200	1800	2400	3000 A
4000/5A	-	400 A	4000 A	400 A	800	1600	2400	3200	4000 A
5000/5A	-	500 A	5000 A	500 A	1000	2000	3000	4000	5000 A

Înterupătoare pentru protecția motoarelor

400 V AC	U_i 690 V	U_{imp} 6 kV	50/60 Hz	$\times 10^5$	$\times 10^5$	ON-OFF-ON... sc/h $\times 25$	AC 3		IP 20	T_a -25..+55°C	[mm²] 2x1-2x6	Class Ir 10A	P_m 2,5 VA AC
-----------------	-------------------------------	--------------------------------	----------	---------------	---------------	-------------------------------------	-------------	--	--------------	------------------------------------	------------------------------------	-------------------------------	-----------------------------------

TRACON	I _e	P _e	I _m		
				aM (A)	gG (A)
TGV2-01	0,1 - 0,16 A	-	1,5 A	-	1
TGV2-02	0,16 - 0,25 A	0,06 kW	2,4 A	-	1
TGV2-03	0,25 - 0,4 A	0,09 kW	5 A	1	2
TGV2-04	0,4 - 0,63 A	0,18 kW	8 A	1	2
TGV2-05	0,63 - 1 A	0,37 kW	13 A	1	2
TGV2-06	1 - 1,6 A	0,55 kW	22,5 A	2	4
TGV2-07	1,6 - 2,5 A	0,75 kW	33,5 A	4	6
TGV2-08	2,5 - 4 A	1,5 kW	51 A	6	10
TGV2-10	4 - 6,3 A	2,2 kW	78 A	10	16
TGV2-14	6 - 10 A	4 kW	138 A	10	20
TGV2-16	9 - 14 A	5,5 kW	170 A	16	25
TGV2-20	13 - 18 A	7,5 kW	223 A	20	32
TGV2-21	17 - 23 A	11 kW	327 A	25	50
TGV2-22	20 - 25 A	11 kW	327 A	25	50
TGV2-32	24 - 32 A	15 kW	416 A	40	63

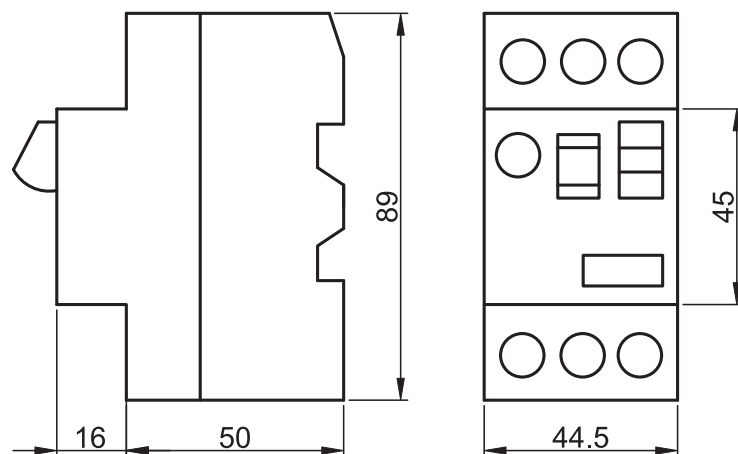

RELEVANT STANDARD
EN 60947-4-1

RELEVANT STANDARD
EN 60947-1

TÜV MEEI TEST DOCUMENTATION
28209137-001



Înterupătoarele se folosesc la pornirea/oprirea și protecția sarcinilor trifazice, în special a motoarelor trifazice. Declanșarea poate fi termică sau magnetică. De asemenea asigură protecție la supraîncălzire din cauza lipsei tensiunii pe o fază. Sistemul frontal de butoane mecanice servește la pornirea și oprirea înterupătorului. Curentul nominal al motorului se reglează cu butonul frontal al aparatului, în plaja de reglaj al acestuia. Înterupătoarele pentru protecția motoarelor de tip „TGV” cu ajutorul accesoriilor (contacte auxiliare, din material izolant, indicatoare, declanșatoare) pot fi utilizate pentru comandă de la distanță, inclusiv în sisteme de comandă.

Curbă caracteristică de decuplare

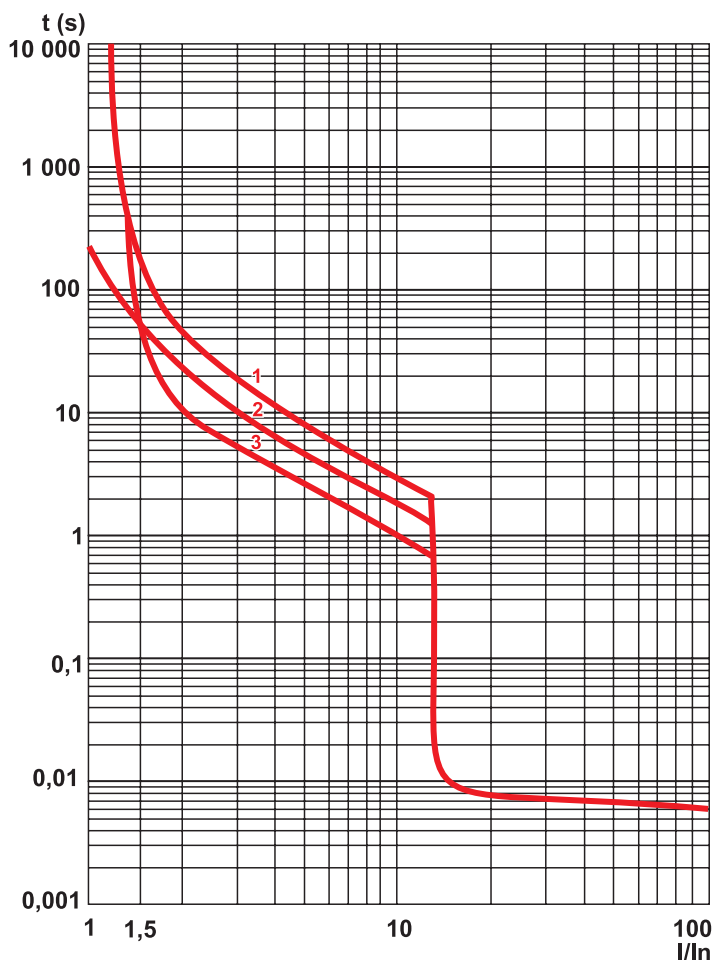

Legendă:

- 1:** tripolară cu pornire la rece
- 2:** bipolară cu pornire la rece
- 3:** tripolară cu pornire la cald

Curbă caracteristică de limitare curent

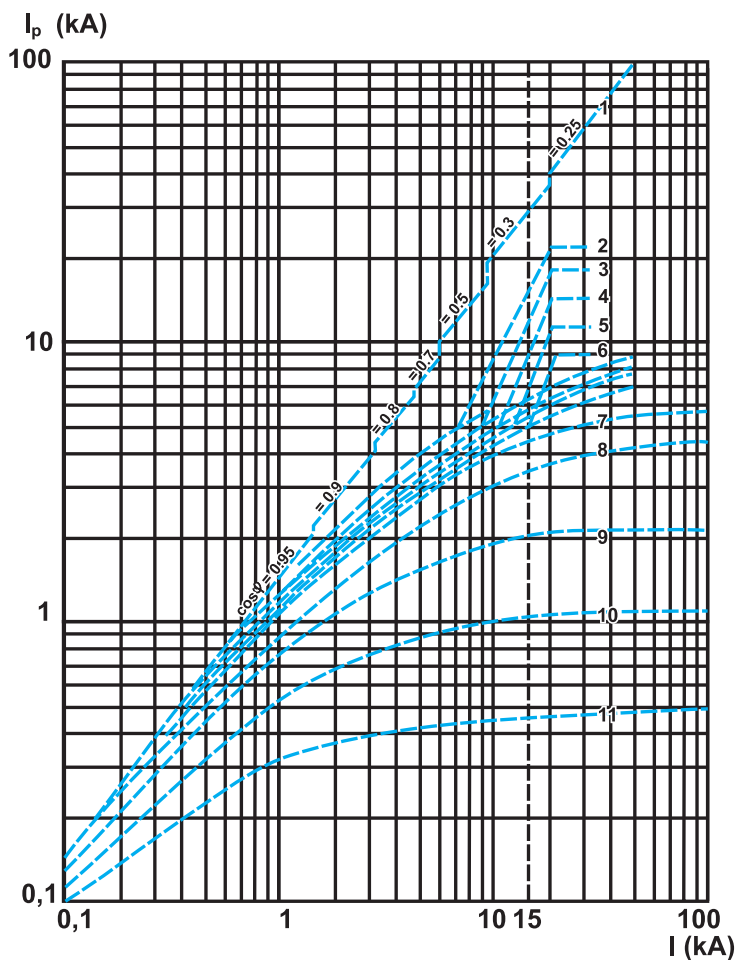

Legendă:

- | | | |
|----------------------|-------------------|----------------------|
| 1: I_{pmax} | 5: 13-18 A | 9: 2.5-4 A |
| 2: 24-32 A | 6: 9-14 A | 10: 1.6-2.5 A |
| 3: 20-25 A | 7: 6-10 A | 11: 1-1.6 A |
| 4: 17-23 A | 8: 4-6.3 A | |

Accesorii

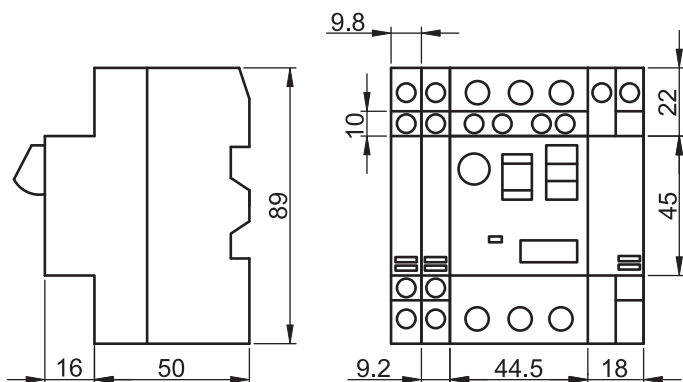

Cu ajutorul accesoriilor (contacte auxiliare, indicatoare, declanșatoare, carcase, etc.) întrerupătoarele pentru protecția motoarelor pot fi utilizate pentru comandă de la distanță, inclusiv în sisteme de comandă. Prin utilizarea carcaselor întrerupătoarele pentru protecția motoarelor pot fi utilizate și independent, astfel gradul de protecție poate fi crescut la IP 41 respectiv IP 55.

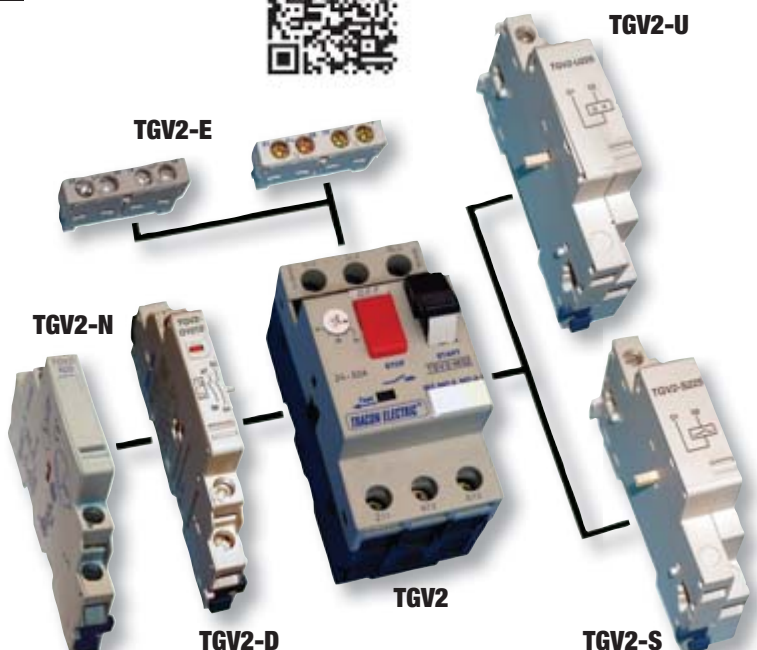

Contacte auxiliare frontale

U_e (V)		24	48	60	230
I_e (A)	AC15	2	1,25	-	0,5
	DC13	1	0,3	0,15	-
I_{th} (A)		2,5 A			

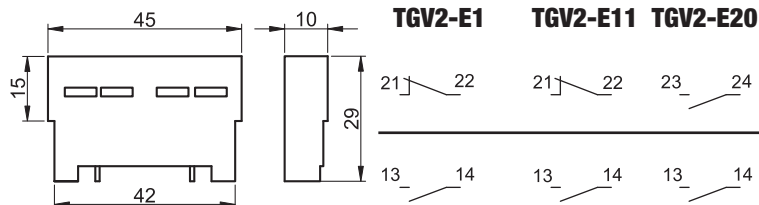

TRACON	NC NO
TGV2-E1	1×NC / NO*
TGV2-E11	1×NC + 1×NO
TGV2-E20	2×NO

* Caracterul normal deschis sau normal închis depinde de poziționarea contactului

Informează starea închisă sau deschisă a întrerupătorului de protecție. Oferă posibilitate pentru executarea funcțiilor de semnalizare sau comandă. Contactul auxiliar frontal poate fi montat după îndepărtarea capacului frontal.

Contacte auxiliare laterale



U_e (V)		24	48	110	230	400
I_e (A)	AC15	-	6	4,5	3	2
	DC13	6	5	1,3	0,5	-
I_{th} (A)		6 A				

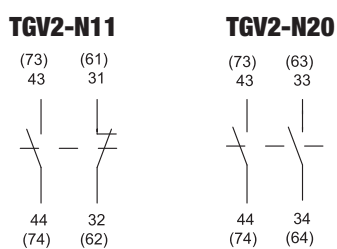

TRACON	NC NO
TGV2-N11	1×NC + 1×NO
TGV2-N20	2×NO

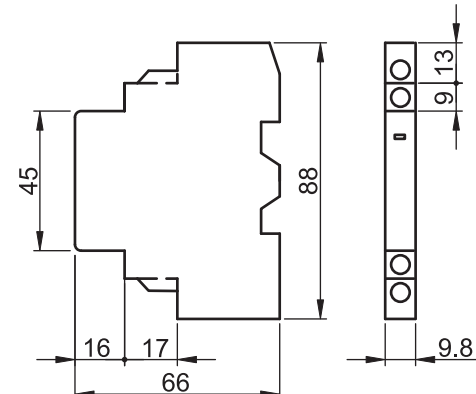

Informează starea închisă sau deschisă a întrerupătorului de protecție. Oferă posibilitate pentru executarea funcțiilor de semnalizare sau comandă.

Indicator declanșare la scurtcircuit



U_e (V)		24	48	60
I_e (A)	AC15	1,5	1	-
	DC13	1	0,3	0,15
I_{th} (A)		2,5 A		

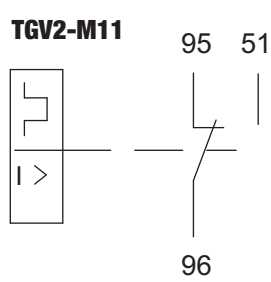

TRACON	NC NO CO
TGV2-M11	1×CO

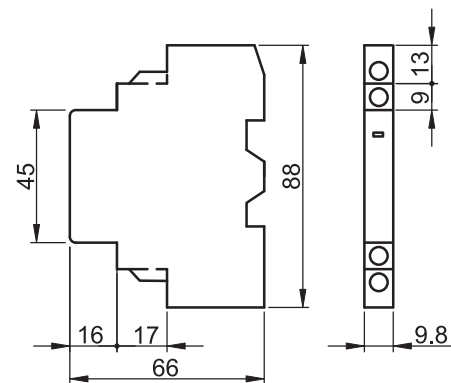

În cazul defectării motorului protejat semnalează defecțiunii (scurtcircuit, suprasarcină).

Indicator declanșare la suprasarcină

TRACON	AUX	
TGV2-D1010	1×NO	1×NO
TGV2-D1001	1×NC	1×NO
TGV2-D0110	1×NO	1×NC
TGV2-D0101	1×NC	1×NC

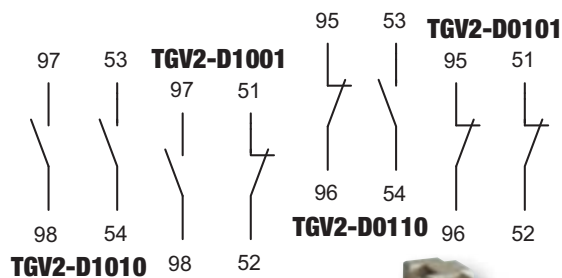

U_e (V)	AUX 							
	24	48	60	24	48	230	400	
I_e (A)	AC15	1.5	1	-	-	6	3	2
	DC13	1	0.3	0.15	6	5	0.5	-
I_{th} (A)	2,5 A			6 A				

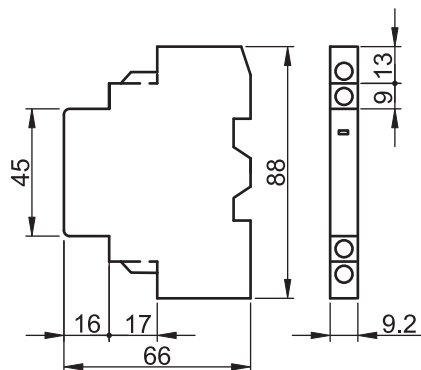

Declanșator de tensiune minimă

TRACON	U_m	P_m
TGV2-U225	220-240 V AC	max. 5 VA
TGV2-U385	400-415 V AC	max. 5 VA

Declanșatorul va acționa întrerupătorul dacă tensiunea de la bornele declanșatorului scade la 35-70% din valoarea tensiunii nominale de acționare.

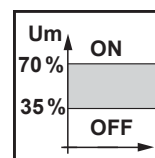
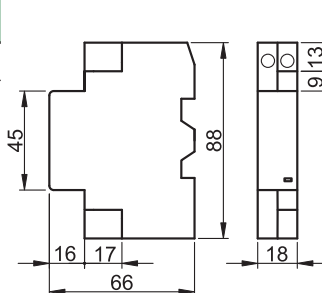
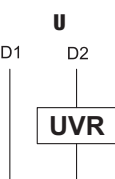

Declanșator tensiune de lucru

TRACON	U_m	P_m
TGV2-S225	220-240 V AC	max. 5 VA
TGV2-S385	400-415 V AC	max. 5 VA

Dacă la borne apare 70-110% din tensiunea nominală de acționare, întrerupătorul va decupla. Astfel îndeplinește funcția de comandă de la distanță.

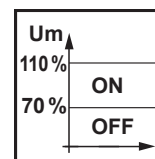
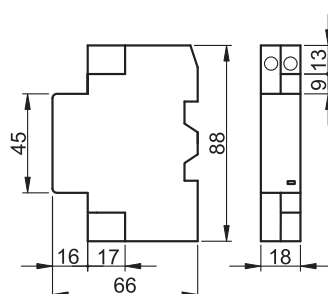
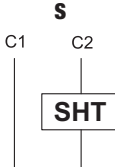

Cutii

TRACON	IP..
TGV2-T1	IP 41
TGV2-T2	IP 55

