















































































Piktogrami zaglavlja tabela

 Nazivni napon (V)	 Nazivna struja (A)	 Max. snaga	 Snaga polaska
 Vod punog, pouznanog, savitljivog preseka	 Maksimalni poprečni presek provodnika	 Dimenzije (LxWxH)	 Masa
 Merni instrument sa elektromehanička displejem	 Merni instrument sa LCD displejem	 Displej (broj digita)	 Napajanje
 Prenosni odnos	 Šant	 Davač tipa baterije	 Prijemnik tipa baterije
 Širina šine (strujni transformator)	 Prečnik provodnika (strujni transformator)	 Neposredni merni instrument	 Merni instrument sa strujnim transformatorom
 Impulsni izlaz	 Širina impulsa	 Polazna struja	 Bazna struja (maksimalna struja)
 Kondenzatorskih baterija	 Merenje temperature	 Dimenzije ugradnje	 Opseg merenja
 Klasa tačnosti	 Broj strujnih transformatora	 Dimenzije isecanja (mm)	

Piktogrami tehničkih podataka

 Otpornost na vibracije	 Nazivna termička struja	 Faktor sigurnosti	 Pomoćni kontakti
 Baždaren strujni transformator	 Relativna vlažnost vazduha	 Izdržljivost naponskog impulsa	 Stepenn zaštite (sa čeonu strane) u ugrađenom stanju
 Nazivna dinamička struja	 Displej brojača radnih sati	 Zamenljiva skalna ploča	 Sopstvena potrošnja
 Nazivni izolacioni napon	 Trajno preopterećenje	 Optički signal	 Impulsni izlaz
 Zakretni prekidač	 Trenutno preopterećenje	 Linearna skala	 Nezamenljiva skalna ploča
 Trajno preopterećenje	 Merenje AC napona	 Signal niskog napona baterije	 Signal polariteta
 Trenutno preopterećenje	 Dioda test	 Ispitivanje baterija	 Logaritmička skala
 Merenje AC struje	 Nazivni napon (V)	 Merenje faktora pojačanja tranzistora	 Zabavljanje
 Merenje DC napona	 Temperatura sredine	 Montaža na montažnu šinu	 Merenje DC struje
 Merenje otpornosti	 Dozvoljeni poprečni presek voda	 Temperatura lagerovanja	 Merenje temperature
 Pogonska temperatura	 Stepenn zaštite stezaljki (oklopljenih)	 Materijal: ABS	 Izdržljivost na plamen
 Stepenn zaštite	 Generator impulsa	 Bezkontaktna detekcija napona	



Voltmetri za nizmienični napon 2



Ampermetri za jednosmernu struju 3



Ampermetri nizmienične struje za posredna merenja 4



Jednosmerni ampermetri za posredna merenja 5



Vatmetri 6



Frekvencmetri 7



cos φ metri (faktora snage) 7



Brojači radnih sati 8

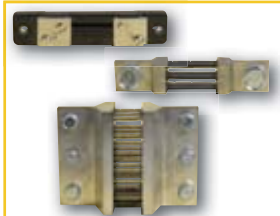

Šantovi tipa TSF 8



Analogni voltmetri sa nizanjem 9



Analogni ampermetri sa nizanjem za posredna merenja, DC 9



Analogni frekvencmetri uz mogućnost nizanja 10



Analogni cos φ metri uz mogućnost nizanja 10



Digitalni merni instrumenti uz mogućnost nizanja 10



Analogni vatmetri uz mogućnost nizanja 11



Neposredni digitalni ampermetar 12



Digitalni cos φ metar 14



Digitalni multimetri 15



Mrežni analizator 17



Brojila 18



Digitalna brojila sa utakanjem 20



Regulatori jalove snage 21



Niskonaponski strujni merni transformatori 26



Strujni merni transformatori za baždarenje 28



Digitalni multimetar 30



Digitalni adapter strujnih klješta za instrument tipa EM420A 31



Digitalna merna klješta 32



Detektor metala 33



Infra termometar 33



Ručni digitalni multimetar sa svjetiljkom 33



Ispitivač faze, odvijač (šrafciğer) 34



Tester napona 34



Indukcijski kontrolni aparat 34



Aparat za detektiranje napona 34



Probna svjetiljka za automobile 35

Voltmetri za naizmenični napon

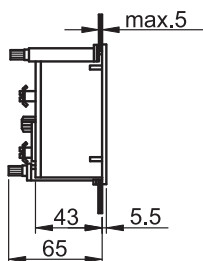
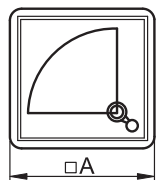
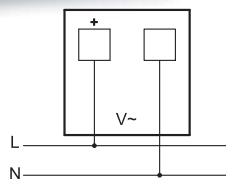
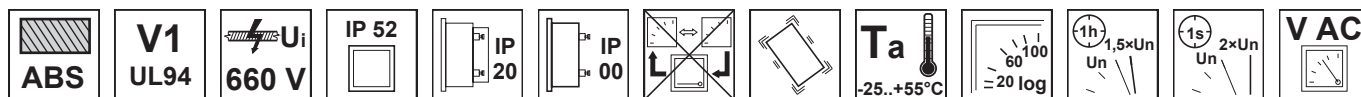

TRACON				
ACVM96-30	96 × 96 mm	0-30 V	1,5 %	90 mm
ACVM96-120	96 × 96 mm	0-120 V	1,5 %	90 mm
ACVM96-250	96 × 96 mm	0-250 V	1,5 %	90 mm
ACVM96-450	96 × 96 mm	0-500 V	1,5 %	90 mm
ACVM96-600	96 × 96 mm	0-600 V	1,5 %	90 mm
ACVM72-30	72 × 72 mm	0-30 V	1,5 %	66 mm
ACVM72-120	72 × 72 mm	0-120 V	1,5 %	66 mm
ACVM72-250	72 × 72 mm	0-250 V	1,5 %	66 mm
ACVM72-450	72 × 72 mm	0-500 V	1,5 %	66 mm
ACVM72-600	72 × 72 mm	0-600 V	1,5 %	66 mm
ACVM48-30	48 × 48 mm	0-30 V	1,5 %	42 mm
ACVM48-120	48 × 48 mm	0-120 V	1,5 %	42 mm
ACVM48-250	48 × 48 mm	0-250 V	1,5 %	42 mm
ACVM48-450	48 × 48 mm	0-500 V	1,5 %	42 mm
ACVM48-600	48 × 48 mm	0-600 V	1,5 %	42 mm

RELEVANT STANDARD
EN 60051

RELEVANT STANDARD
EN 61010

Voltmetri za jednosmerni napon

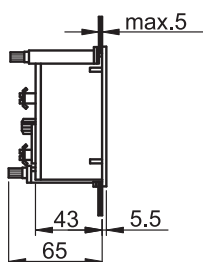
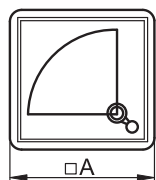
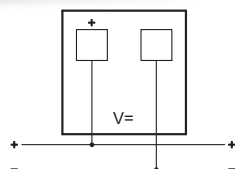
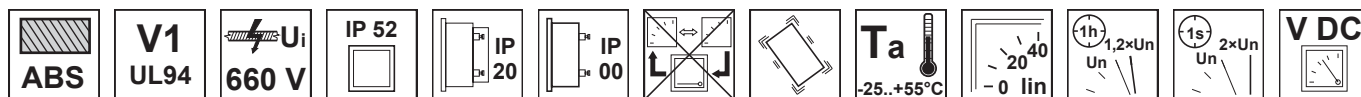

TRACON				
DCVM96-30	96 × 96 mm	0-30 V	1,5 %	90 mm
DCVM96-120	96 × 96 mm	0-120 V	1,5 %	90 mm
DCVM96-250	96 × 96 mm	0-250 V	1,5 %	90 mm
DCVM96-400	96 × 96 mm	0-400 V	1,5 %	90 mm
DCVM96-600	96 × 96 mm	0-600 V	1,5 %	90 mm
DCVM72-30	72 × 72 mm	0-30 V	1,5 %	66 mm
DCVM72-120	72 × 72 mm	0-120 V	1,5 %	66 mm
DCVM72-250	72 × 72 mm	0-250 V	1,5 %	66 mm
DCVM72-400	72 × 72 mm	0-400 V	1,5 %	66 mm
DCVM72-600	72 × 72 mm	0-600 V	1,5 %	66 mm
DCVM48-30	48 × 48 mm	0-30 V	1,5 %	42 mm
DCVM48-120	48 × 48 mm	0-120 V	1,5 %	42 mm
DCVM48-250	48 × 48 mm	0-250 V	1,5 %	42 mm
DCVM48-400	48 × 48 mm	0-400 V	1,5 %	42 mm
DCVM48-600	48 × 48 mm	0-600 V	1,5 %	42 mm

RELEVANT STANDARD
EN 60051

Objašnjenje piktograma **L/O**

Ampermetri za naizmeničnu struju

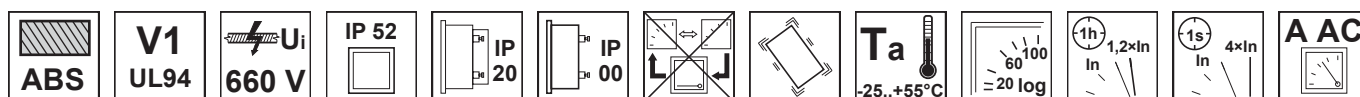

TRACON				
ACAM96-5	96 × 96 mm	0-5 A	1,5 %	90 mm
ACAM96-10	96 × 96 mm	0-10 A	1,5 %	90 mm
ACAM96-30	96 × 96 mm	0-30 A	1,5 %	90 mm
ACAM96-50	96 × 96 mm	0-50 A	1,5 %	90 mm
ACAM96-75	96 × 96 mm	0-75 A	1,5 %	90 mm
ACAM96-105	96 × 96 mm	0-100 A	1,5 %	90 mm
ACAM72-5	72 × 72 mm	0-5 A	1,5 %	66 mm
ACAM72-10	72 × 72 mm	0-10 A	1,5 %	66 mm
ACAM72-30	72 × 72 mm	0-30 A	1,5 %	66 mm
ACAM72-50	72 × 72 mm	0-50 A	1,5 %	66 mm
ACAM72-75	72 × 72 mm	0-75 A	1,5 %	66 mm
ACAM48-5	48 × 48 mm	0-5 A	1,5 %	42 mm

RELEVANT STANDARD
EN 60051

RELEVANT STANDARD
EN 61010

Instrumenti su sa mekim gvoždem, koji neposredno prikazivaju realne efektivne vrednosti struja mreža sa naizmeničnim strujama, u oblasti od 0 do 100 A, bez naknadno ugrađene bilo kakvog pribora. Izvedba logaritamske skale je takva, da pri punom otklonu kazaljke merena vrednost je dva puta veća od mernog opsega.

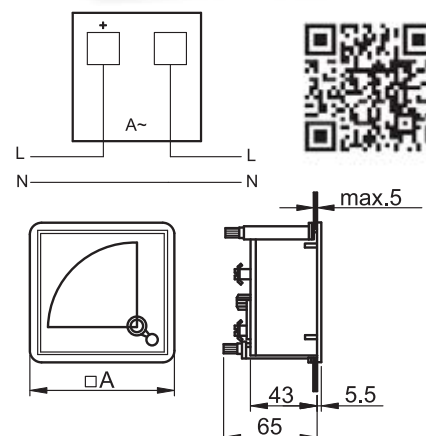

Ampermetri za jednosmernu struju

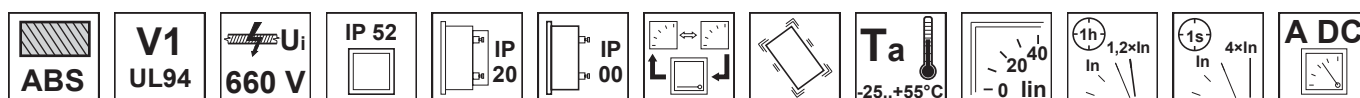

Jednosmerni miliampermetri

TRACON				
DCAM96-0,02	96 × 96 mm	0-20 mA	1,5 %	90 mm
DCAM72-0,02	72 × 72 mm	0-20 mA	1,5 %	66 mm
DCAM48-0,02	48 × 48 mm	0-20 mA	1,5 %	42 mm

Ampermetri za jednosmernu struju

TRACON				
DCAM96-5	96 × 96 mm	0-5 A	1,5 %	90 mm
DCAM96-20	96 × 96 mm	0-20 A	1,5 %	90 mm
DCAM72-5	72 × 72 mm	0-5 A	1,5 %	66 mm
DCAM72-20	72 × 72 mm	0-20 A	1,5 %	66 mm
DCAM48-5	48 × 48 mm	0-5 A	1,5 %	42 mm
DCAM48-20	48 × 48 mm	0-20 A	1,5 %	42 mm

RELEVANT STANDARD
EN 60051

RELEVANT STANDARD
EN 61010

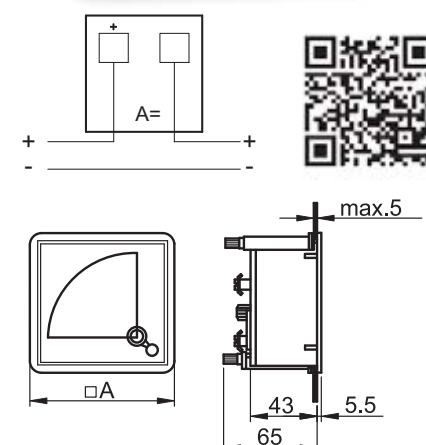

Ampermetri naizmenične struje za posredna merenja, sa izmenom skale

Instrumenti se upotrebljavaju za posredno merenje struja energetskih mreža. Proširenje mernog opsega instrumenta se vrši strujnim transformatorom, u čije sekundarno strujno kolo od 5 A je vezan osnovni instrument naizmenične struje. Za osnovni instrument se može naručiti merna skala sa mernim opsegom 0-X, prema priloženoj tabeli.

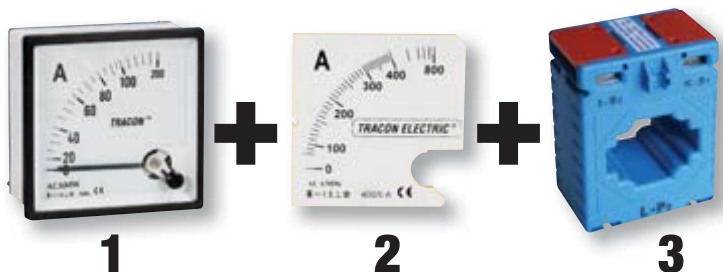

(1) Instrumenti naizmenične struje

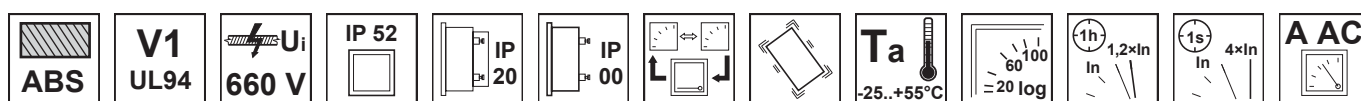

TRACON				
ACAM96-5	96 × 96 mm	0-5 A	1,5 %	90 mm
ACAM72-5	72 × 72 mm	0-5 A	1,5 %	66 mm
ACAM48-5	48 × 48 mm	0-5 A	1,5 %	42 mm

		RELEVANT STANDARD EN 60051	
		RELEVANT STANDARD EN 61010	

(2) Prednje (skalne) ploče ampermetara ACAM...

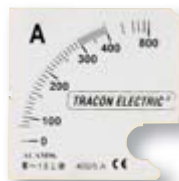

TRACON		
SCALE-AC96-X/5A	96 × 96 mm	0-X (A)
SCALE-AC72-X/5A	72 × 72 mm	0-X (A)
SCALE-AC48-X/5A	48 × 48 mm	0-X (A)

Uz narudžbu se molimo naznačiti vrednost X prema željenoj vrednosti struje!

(3) Tabela strujnih transformatora i pripadajućih ploča sa skalom za posredna merenja



L/26

0-X	0-X	0-X	0-X	0-X	0-X	0-X	0-X
30/5	0-30 A	120/5	0-120 A	400/5	0-400 A	1500/5	0-1500 A
40/5	0-40 A	125/5	0-125 A	500/5	0-500 A	2000/5	0-2000 A
50/5	0-50 A	150/5	0-150 A	600/5	0-600 A	2500/5	0-2500 A
60/5	0-60 A	200/5	0-200 A	750/5	0-750 A	3000/5	0-3000 A
75/5	0-75 A	250/5	0-250 A	800/5	0-800 A	4000/5	0-4000 A
80/5	0-80 A	300/5	0-300 A	1000/5	0-1000 A	5000/5	0-5000 A
100/5	0-100 A						

Uz narudžbu se molimo naznačiti vrednost X prema željenoj vrednosti struje!

Jednosmerni ampermetri za posredna merenja, sa izmenom skalnom pločom



instrumenti se primenjuju za posredna merenja vrednosti struja u mrežama jake struje. Proširivanje mernog opsega instrumenata se ostvaruje upotrebom šanta, za čije merne stezaljke je priključen instrument osnovne izvedbe naponske oblasti od 0 do 75 mV. Za osnovni instrument se može naručiti skalna ploča merne oblasti 0-X, shodno priloženoj tabeli.

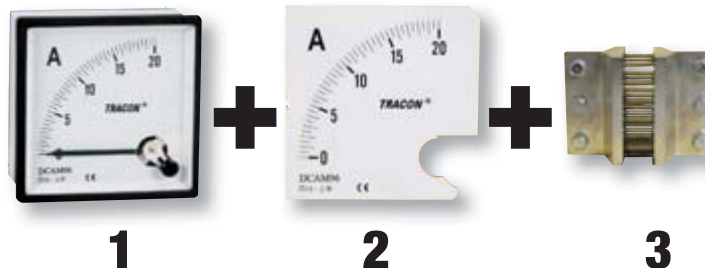

(1) Osnovni instrument za merenje jednosmernog napona

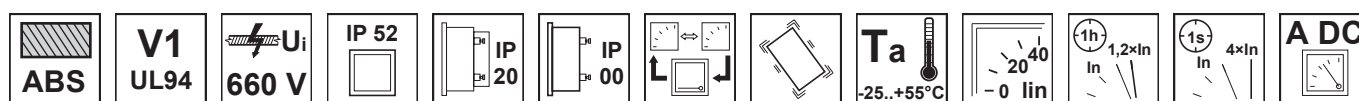

TRACON				
DCVM-96B	96 × 96 mm	0-75 mV	1,5 %	90 mm
DCVM-72B	72 × 72 mm	0-75 mV	1,5 %	66 mm
DCVM-48B	48 × 48 mm	0-75 mV	1,5 %	42 mm

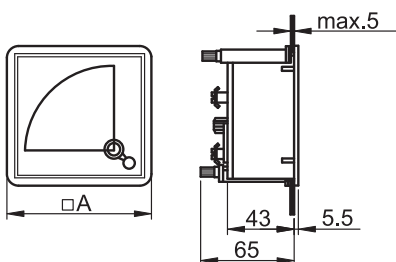

RELEVANT STANDARD
EN 60051

RELEVANT STANDARD
EN 61010

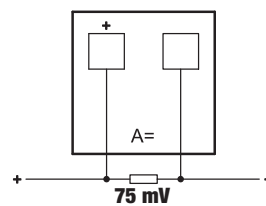

(2) Prednje (skalne) ploče za merenje jednosmernog napona

TRACON		
SCALE-DC96-X/75mV	96 × 96 mm	0-X (A)
SCALE-DC72-X/75mV	72 × 72 mm	0-X (A)
SCALE-DC48-X/75mV	48 × 48 mm	0-X (A)

Uz narudžbu se molimo naznačiti vrednost X prema željenoj vrednosti struje!



(3) Tabela šantova i pripadajućih skalnih ploča za posredna merenja

75mV	0-X	75mV	0-X	75mV	0-X	75mV	0-X
TSF-30	0-30 A	TSF-100	0-100 A	TSF-400	0-400 A	TSF-1000	0-1000 A
TSF-40	0-40 A	TSF-150	0-150 A	TSF-500	0-500 A	TSF-1500	0-1500 A
TSF-50	0-50 A	TSF-200	0-200 A	TSF-600	0-600 A	TSF-2000	0-2000 A
TSF-75	0-75 A	TSF-300	0-300 A	TSF-750	0-750 A	TSF-3000	0-3000 A

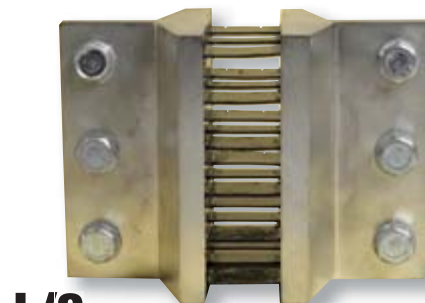

L/8

Molimo, pri naručivanju, naznačiti X vrednost mernog opsega shodno željenim vrednostima struja!



Vatmetri

Mere aktivne snage mono – i trofaznih opterećenja. Merni opseg instrumentima je određen primarnom strujom (X) primenjenih strujnih transformatora sekundarne struje od 5 A. Kod verzija sa otvorom ugradnje 96×96 mm plastično kućište mernog pretvarača i osnovni instrument formiraju organsku celinu, dok kod izvedbe sa otvorom ugradnje 72×72 mm merni pretvarač se posebno isporučuje, i u komandnom ormanu se posebno ugrađuje. Za merne instrumente može se posebno naručiti i skalna ploča, shodno priloženoj tabeli.



(1) Vatmetri



TRACON			U_n	I_n				
W96-400V/4	96 × 96 mm	0-100	400 V~	X/5 A	1,5 %	90 mm	× 3	L1, L2, L3, N
W72-400V/4	72 × 72 mm	0-100	400 V~	X/5 A	1,5 %	66 mm	× 3	L1, L2, L3, N

(2) Skalne ploče za merenje snage

	TRACON L1, L2, L3, N		
	SCALE-W96/4-P	96 × 96 mm	0-P (kW)
	SCALE-W72/4-P	72 × 72 mm	0-P (kW)

Molimo naznačiti vrednosti X i P prilikom naručivanja!

(3) Tabela usaglašavanja strujnih transformatora i skalnih ploča za mono – odnosno trofazna merenja snage

n	3~	n	3~	n	3~
30/5	24 kW	125/5	100 kW	750/5	600 kW
40/5	32 kW	150/5	120 kW	800/5	640 kW
50/5	40 kW	200/5	160 kW	1000/5	800 kW
60/5	48 kW	250/5	200 kW	1500/5	1200 kW
75/5	60 kW	300/5	240 kW	2000/5	1600 kW
80/5	64 kW	400/5	320 kW	2500/5	2000 kW
100/5	80 kW	500/5	400 kW	4000/5	3200 kW
120/5	96 kW	600/5	480 kW	5000/5	4000 kW



L/26

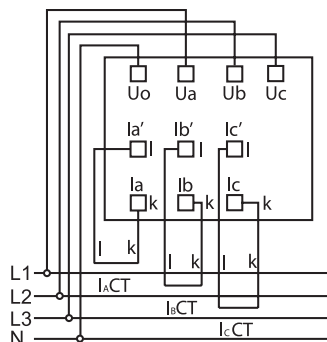

Legenda

CT = strujni transformator
k, l = sekundarne stezaljke strujnog transformatora

Frekvencmetri

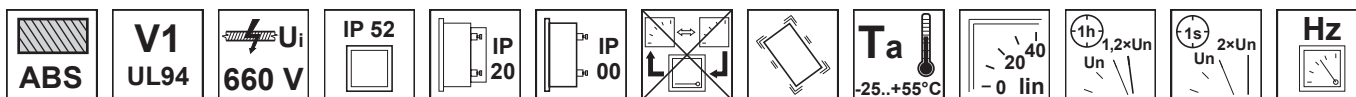

TRACON				
F96-220/50	96 × 96 mm	45-55 (230 V)	1,5 %	90 mm
F72-220/50	72 × 72 mm	45-55 (230 V)	1,5 %	66 mm
F48-220/50	48 × 48 mm	45-65 (230 V)	2,5 %	42 mm

Instrumenti mere frekvenciju niskonaponskih mreža u oblasti frekvencije 45-55 Hz. Na merne stezaljke naprave se priključuje mrežni napon, pomoću mernog pretvarača smeštenog u kućištu instrumenta pokaziva vrednost učestanosti.

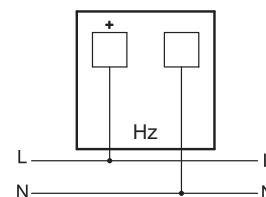
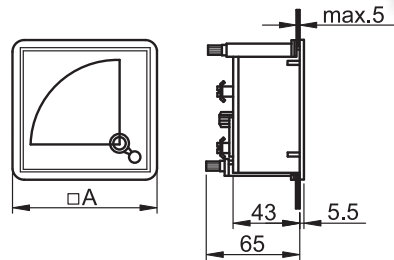

RELEVANT STANDARD
EN 60051

RELEVANT STANDARD
EN 61010

cos φ metri (faktora snage)



TRACON			U_n	I_n		
CF96-0,5/1	96 × 96 mm	0,5 cap-1-0,5 ind	240 V~	X/5 A	1,5 %	90 mm
CF72-0,5/1	72 × 72 mm	0,5 cap-1-0,5 ind	240 V~	X/5 A	1,5 %	66 mm
CF96-0,5/3	96 × 96 mm	0,5 cap-1-0,5 ind	400 V~	X/5 A	2,5 %	90 mm
CF72-0,5/3	72 × 72 mm	0,5 cap-1-0,5 ind	400 V~	X/5 A	2,5 %	66 mm

Mere vrednosti faktora snage u mono – odnosno trofaznim mrežama u oblasti 0,5 kapacitivno – 0,5 induktivno. U strujnom mernom krugu instrumenta, u slučaju većih struja od 5 A, treba primeniti strujni transformator sekundarne struje od 5 A. Zavisno od induktivnog ili kapacitivnog karaktera mreže, kazaljka se kreće na desno ili na levo na simetričnoj skalnoj ploči respektivno. Merni pretvarač je ugrađen u kućište instrumenta.



Karakter opterećenja
Lead=kapacitivan,
Lag-induktivan

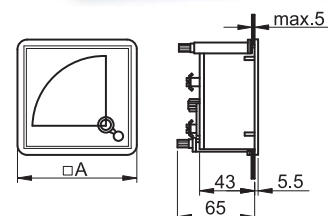

Šeme veza u slučaju monofaznih mreža

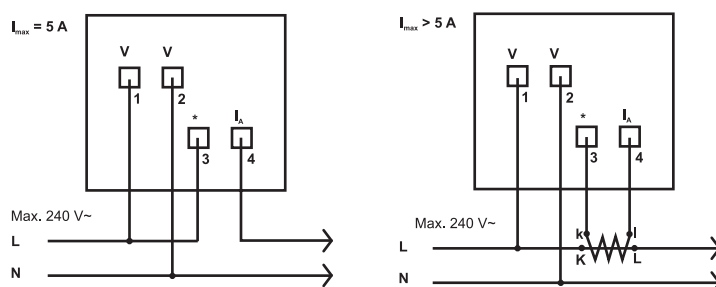

Šeme veza u slučaju trofaznih mreža

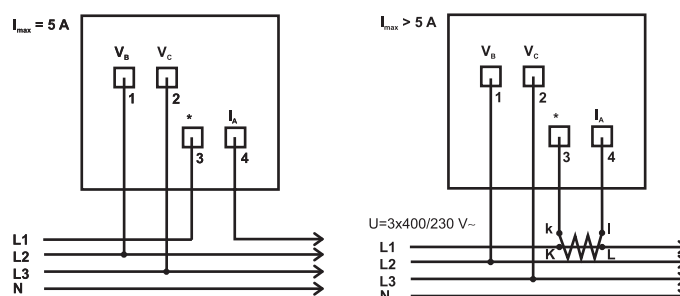

Brojači radnih sati



V1
UL94

U_i
660 V

IP 40

IP 20

IP 00



Ta
-25...+55°C

0014
analog

000000
99999,9

Objašnjenje
piktograma

L/O

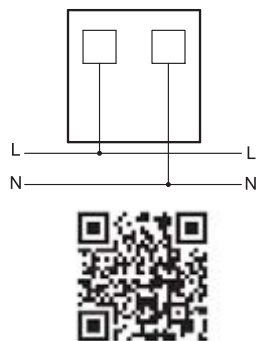

TRACON

ISZ72-24	72 × 72 mm	66 mm
ISZ72-230	72 × 72 mm	66 mm
ISZ96-24	96 × 96 mm	90 mm
ISZ96-230	96 × 96 mm	90 mm

Displej instrumenata se ne može vratiti na nultu vrednost!

Šantovi tipa TSF

TRACON		L (mm)	C (mm)	B (mm)	H (mm)	M (mm)
TSF-30	30A/75mV	120	102	25	15	-
TSF-40	40A/75mV	120	102	25	15	-
TSF-50	50A/75mV	120	102	25	15	-
TSF-75	75A/75mV	110	86	23	10	M8 × 35
TSF-100	100A/75mV	106	86	23	10	M8 × 35
TSF-150	150A/75mV	116	86	21	22	M8 × 35
TSF-200	200A/75mV	116	86	21	22	M8 × 35
TSF-300	300A/75mV	127	100	26	22	M10 × 35

TRACON		L (mm)	C (mm)	B (mm)	H (mm)	M (mm)
TSF-400	400A/75mV	126	100	35	22	M10 × 35
TSF-500	500A/75mV	126	100	43	22	M10 × 35
TSF-600	600A/75mV	126	100	50	22	M10 × 35
TSF-750	750A/75mV	126	102	74	22	M10 × 35
TSF-1000	1000A/75mV	126	102	94	22	M12 × 60
TSF-1500	1500A/75mV	200	164	90	96	M12 × 60
TSF-2000	2000A/75mV	194	160	90	96	M12 × 60
TSF-3000	3000A/75mV	198	160	142	96	M12 × 60

Usled dejstva električne struje, koja protiče kroz šant, nastaje pad napona na njegovim stezaljkama, koji je srazmeran sa otpornošću šanta. Iskoristeći ovu činjenicu, može se odrediti struja proticanja kroz poznatu otpornost šanta merenjem pada napona na njegovim stezaljkama.

Po mernoj šemi veze milivoltmetar meri pad napona U_m , nastali na šantu R_s , a međuvremeno na njegovoj skali se očitava neposredno vrednost struje, koja potiče kroz šant R_s u Amperima.

Na mernim stezaljkama jednosmernog šanta sa oznakom TFS se pojavljuje napon maksimalne vrednosti od 75 mV, zato je i merni opseg iste vrednosti osnovnih instrumenata primenjenih uz tih šantova.

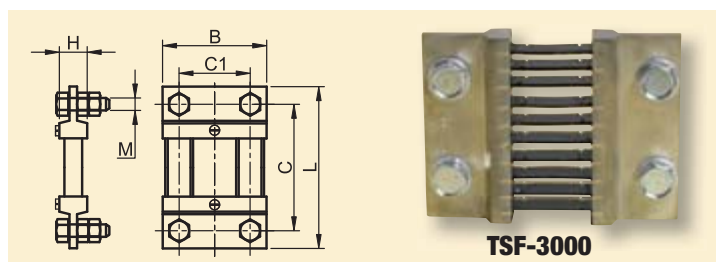
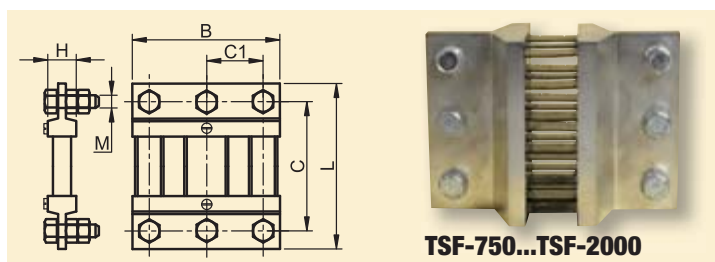
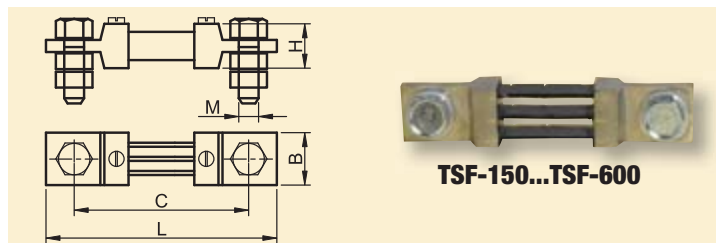
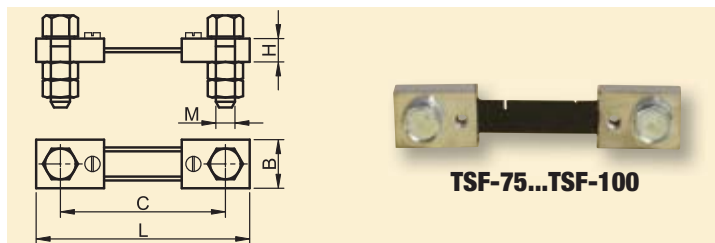
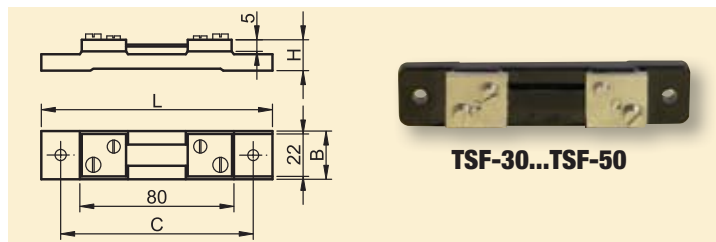
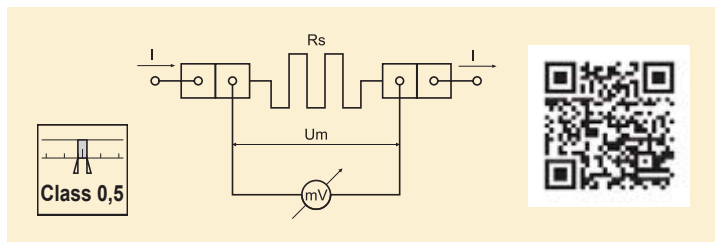

Analogni voltmetri sa nizanjem

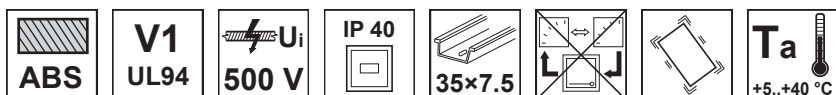

TRACON			
ACVMS-25	V AC	0-25 V	1,5 %
ACVMS-100		0-100 V	1,5 %
ACVMS-450		0-450 V	1,5 %
DCVMS-100	V DC	0-100 V	1,5 %
DCVMS-250		0-250 V	1,5 %

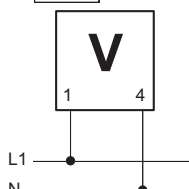
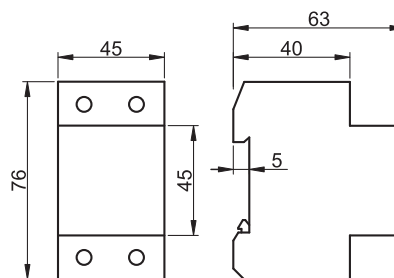

RELEVANT STANDARD
EN 60051

RELEVANT STANDARD
EN 61010

Analogni ampermetri sa nizanjem za neposredna merenja

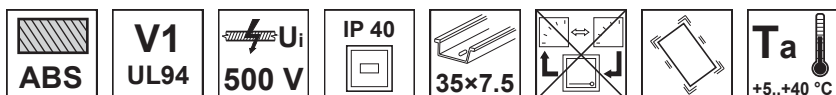

TRACON			
ACAMS-5	A AC	0-5 A	1,5 %
DCAMS-20m*	V DC	0-20 mA	1,5 %
DCAMS-10		0-10 A	1,5 %

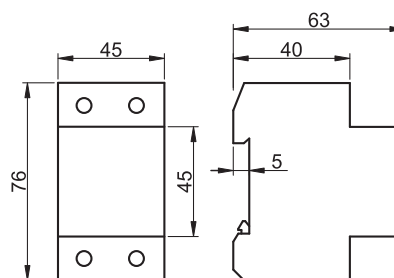

* Miliampermetri jednosmerne strujese primenjavaju u upravno – regulacionim sistemima za merenja unificiranih vrednosti jačine struje. Nakon posebnog spravnijavanja za instrument se može naručiti i jedinstvena skalna ploča, pomoću čega instrument je pogodan i za merenje i prikazivanje nekih drugi fizičkih veličina, pretvorenih u električnu (na pr. sila, temperatura, broj obrtaja).

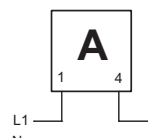

Analogni ampermetri sa nizanjem za posredna merenja, DC

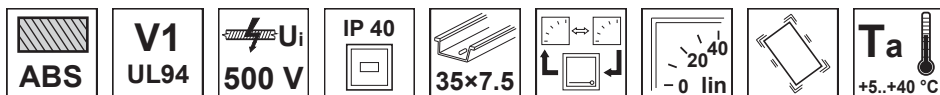

(1) Osnovni instrument za merenje jednosmernog napona

TRACON			
DCVMS-X/75	0-X A		1,5 %

(2) Prednje (skalne) ploče za merenje jednosmernog napona

TRACON		
SCALE-45 DC-X*	0-X (A)	

* Molimo, pri naručivanju, naznačiti X vrednost mernog opsega shodno željenim vrednostima struja!

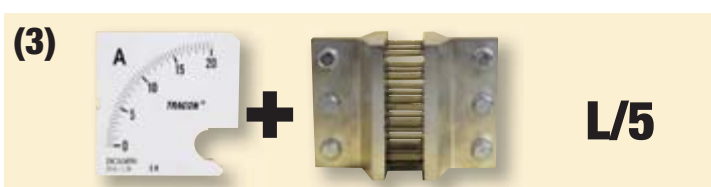
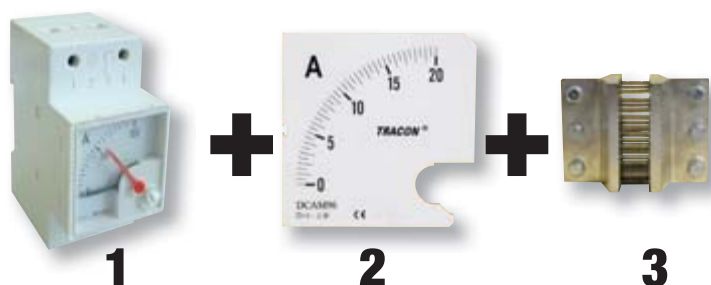

Analogni frekvencmetri uz mogućnost nizanja

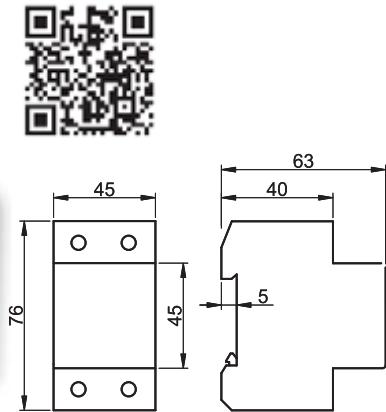
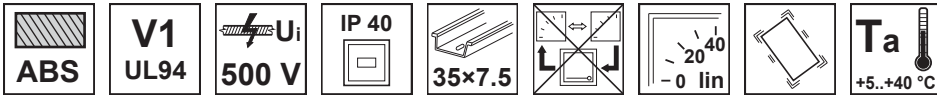

TRACON		
F45S-230/50	45-55Hz	1,0 %

RELEVANT STANDARD
EN 60051

RELEVANT STANDARD
EN 61010

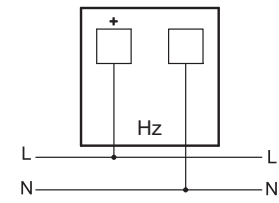

Analogni cosφ metri uz mogućnost nizanja

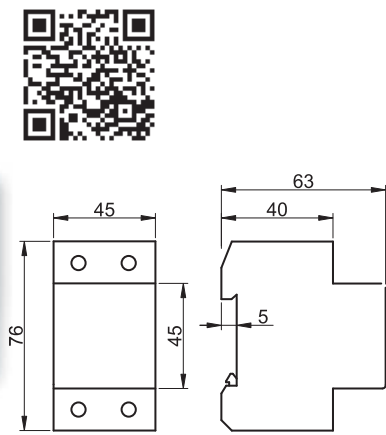
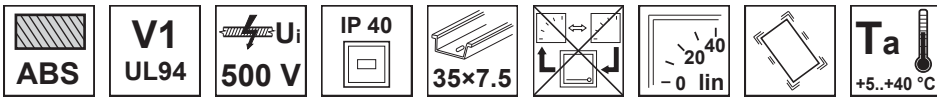

TRACON		
CF45S-0,5/1	5A/230V 1f ±0,5	2,5 %
CF45S-0,5/3	5A/400V 3f ±0,5	2,5 %

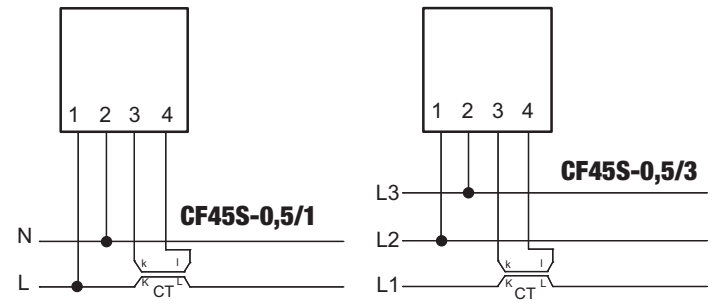

Digitalni merni instrumenti uz mogućnost nizanja

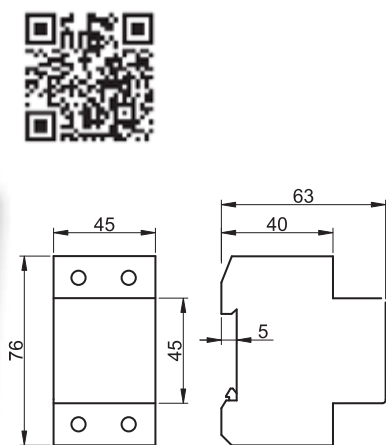
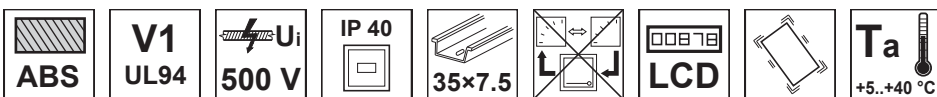

TRACON			
ACAMSD-10		0-10 A	×3 1,5 %
ACVMSD-500		0-500 V	×3 1,5 %

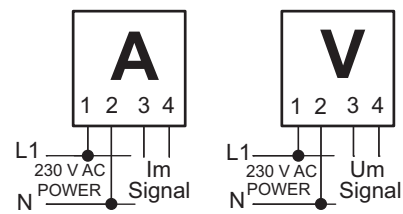

Analogni merni instrumenti snage za nizanje

Mere aktivnu snagu monofazne i trofazne potrošnje.

Takvi instrumenti, čiji merni opseg je određen prema primarnoj struji (X) primenjenih strujnih transformatora čija je sekundarna struja od 5 A.

Upravljačku elektroniku zasebno isporučujemo, i nju u komandnom ormanu treba smestiti posebno. Može se naručiti skalna ploča za merne instrumente, prema priloženoj tabeli.

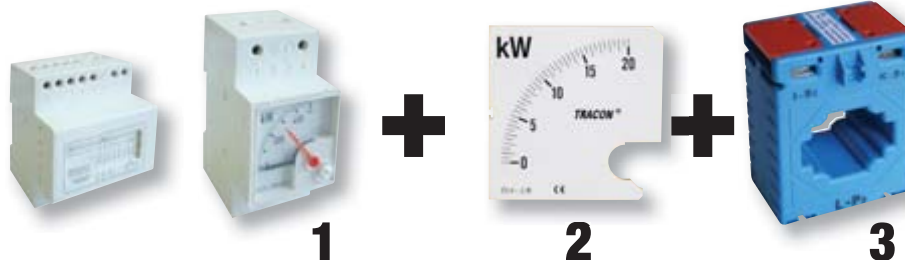
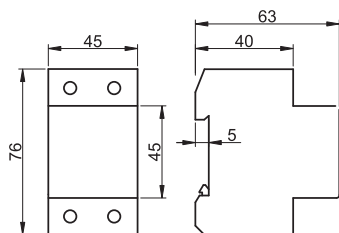

(1) Vatmetri

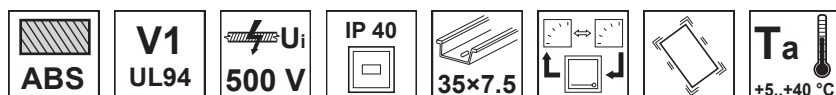

TRACON		U_n	I_n		Σ	
W45S-230/1	0-100	240 V~	X/5 A	1,5 %	×1	L1
W45S-400/4	0-100	400 V~	X/5 A	1,5 %	×3	L1, L2, L3, N

(2) Skalne ploče za merenje snage

TRACON			
L1	L1, L2, L3, N		
SCALE-45 W/1-X	SCALE-45 W/4-X	0-P (kW)	1,5 %



Molimo naznačiti vrednosti X i P prilikom naručivanja!

(3) Tabela usaglašavanja strujnih transformatora i skalnih ploča za mono – odnosno trofazna merenja snage

	1~	3~		1~	3~		1~	3~		1~	3~
30/5	7,5 kW	15 kW	120/5	30 kW	60 kW	400/5	100 kW	200 kW	1500/5	375 kW	750 kW
40/5	10 kW	20 kW	125/5	31,25 kW	62,5 kW	500/5	125 kW	250 kW	2000/5	500 kW	1000 kW
50/5	12,5 kW	25 kW	150/5	37,5 kW	75 kW	600/5	150 kW	300 kW	2500/5	625 kW	1250 kW
60/5	15 kW	30 kW	200/5	50 kW	100 kW	750/5	187,5 kW	375 kW	3000/5	750 kW	1500 kW
75/5	18,75 kW	37,5 kW	250/5	62,5 kW	125 kW	800/5	200 kW	400 kW	4000/5	1000 kW	2000 kW
80/5	20 kW	40 kW	300/5	75 kW	150 kW	1000/5	250 kW	500 kW	5000/5	1250 kW	2500 kW

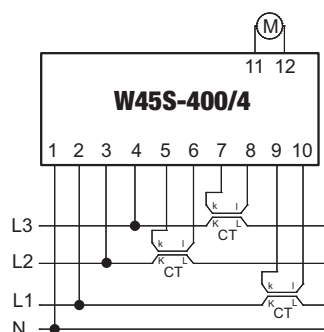
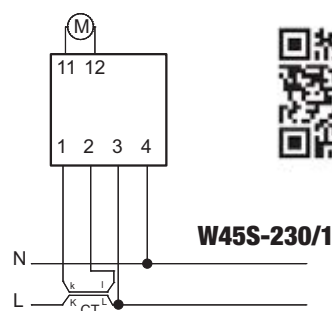

L/26



Učitajte šifru!

- Pogledajte naše novosti
- Budite savremeni

Naš asortiman se brzo i kontinuirano proširuje!
Katalog predstavlja stanje od oktobra 2017.
Za sveže informacije, posetite naš sajt!

Neposredni digitalni ampermetar

230 V AC	ABS	V1 UL94	U _i 660 V	IP 40	IP 20	(0,8-1,2)×Un	Ta -25..+65°C	A AC	Objašnjenje piktograma	L/O
----------	-----	---------	----------------------	-------	-------	--------------	---------------	------	------------------------	-----

TRACON						C (mm)	D (mm)	
ACAMD-96-50	96 × 96 mm	×3	0-50 A AC	± 0,1 %	91 mm	67	8	445 g
ACAMD-72-50	72 × 72 mm	×3	0-50 A AC	± 0,1 %	68 mm	70	6	245 g



Instrument je sposoban neposredno meriti struje neke mreže jačine do 50 A, bez naknadno ugrađene bilo kakve dopune. Napon napajanja se priključuje putem natičnih rednih stezaljki, smeštenih na poledini naprave. Strujni ulaz ampermetra je jedan niskonaponski strujni merni transformator ugrađen na poledini instrumenta, sa prenosnim odnosom od 50/5 A, kroz koji treba prevesti fazni provodnik. Instrument je potpuno automatizovan, merene vrednosti prikazuje displej sa LED na prednjoj ploči od 3 digita.

RELEVANT STANDARD
EN 60051

RELEVANT STANDARD
EN 61010

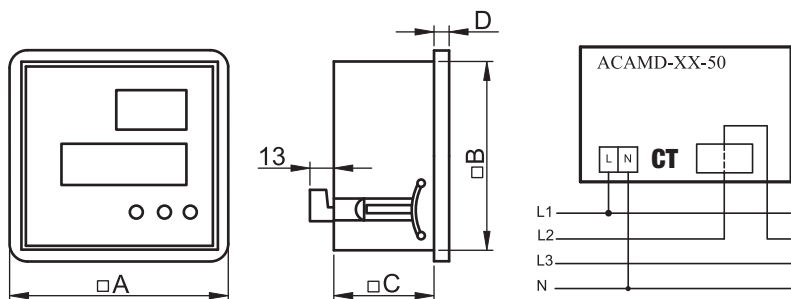

Digitalni ampermetar sa podešljivim strujnim prenosnim odnosom (relejnim izlazom)

230 V AC	ABS	V1 UL94	U _i 660 V	IP 40	IP 20	(0,8-1,2)×Un	Ta -25..+65°C	AUX 1×CO	[mm ²] 1-2,5	A AC
----------	-----	---------	----------------------	-------	-------	--------------	---------------	----------	--------------------------	------

TRACON						C (mm)	D (mm)	
ACAMD-96	96×96 mm	×4	0-9500 A AC	± 2 %	91 mm	67	8	305 g
ACAMD-72	72×72 mm	×4	0-9500 A AC	± 2 %	68 mm	70	6	250 g
ACAMD-P-96*	96×96 mm	×4	0-9500 A AC	± 2 %	91 mm	67	8	320 g
ACAMD-P-72*	72×72 mm	×4	0-9500 A AC	± 2 %	68 mm	70	6	265 g

* Sa programabilnim rel. izlazom



Oba tipa instrumenta su pogodna za merenje efektivne vrednosti naizmenične struje, strujni prenosni odnos (Ct) je podešljiv do vrednosti od 5/5 – 9500/5 A. Programiranje instrumenta se vrši pomoću tastature, smeštene na prednju ploču. Mikroprocesorsko programiranje omogućava korisniku, da kontroliše podešenu vrednost strujnog prenosnog odnosa (Ct), i da odredi kritični nivo struje za željeni prekostrujni alarm kroz relejni izlaz. Instrument tipa ACAMD je verzija tipa ACAMD-P bez relejnog izlaza.

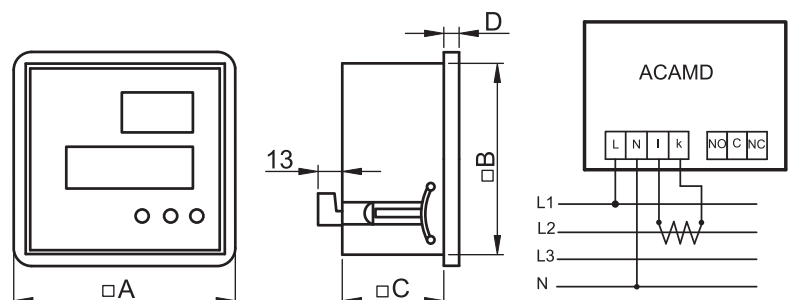

Digitalni voltmetar (sa izborom faze)



TRACON		×digit	U_n				C (mm)	D (mm)	
ACVMD-96-500	96 × 96 mm	×3	240 V~	0-500 V AC	± 1 %	91 mm	67	8	300 g
ACVMD-72-500	72 × 72 mm	×3	240 V~	0-500 V AC	± 1 %	68 mm	70	6	240 g
ACVMD-K-96-500*	96 × 96 mm	×3	400 V~	0-500 V AC	± 1 %	91 mm	67	8	305 g
ACVMD-K-72-500*	72 × 72 mm	×3	400 V~	0-500 V AC	± 1 %	68 mm	70	6	245 g

* izbor željene faze se vrši tasterom na čeonjoj ploči.

Pogodan je za merenje efektivne vrednosti naizmeničnog napona. Tip ACVMD-K-...-500 je konstruisan za merenje efektivnih vrednosti trofaznih naizmeničnih napona, čije vrednosti se mogu prikazati na displeju po izboru korisnika. Priklučivanje napona napajanja, odnosno faznih i nultog provodnika se vrši natičnim rednim stezaljkama smeštenim na zadnju ploču naprave. Vrednost napona se očitava sa LED displeja od 3 digita.

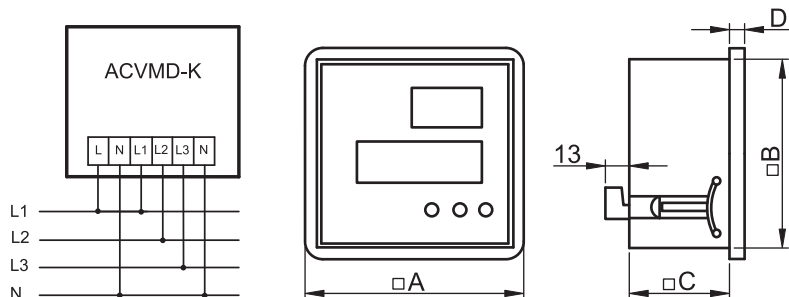

RELEVANT STANDARD
EN 60051

RELEVANT STANDARD
EN 61010

Digitalni ampermetar i voltmetar sa podešljivim strujnim prenosnim odnosom

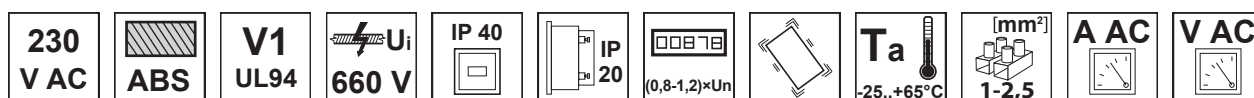

TRACON		×digit					C (mm)	D (mm)	
DTT-1-96	96×96 mm	×3/4	0-500 V AC	0-9500 A AC	± 1 %	91 mm	67	8	325 g
DTT-1-72	72×72 mm	×3/4	0-500 V AC	0-9500 A AC	± 1 %	68 mm	70	6	245 g

Naprava je bazirana na mikroprocesor, pomoću čega se mogu meriti vrednostipriklučenog napona ili struja. Prenosni odnos strujnog mernog transformatora (Ct) je podešljiva od 5/5 do 9500/5 A vrednosti. Instrument meri stvarne efektivne vrednosti veličina (T.R.M.S.), a strujni prenos se podešava tastaturom na prednjem panelu. Priklučivanje napona napajanja, odnosno faznih i nultog provodnika se vrši natičnim rednim stezaljkama smeštenim na zadnju ploču naprave. Vrednost napona se očitava sa LED displeja od 3 digita, a struje od 4 digita.

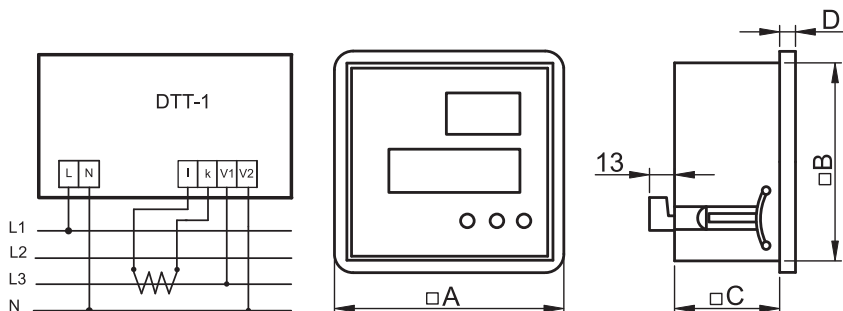

Digitalni frekvencmetar

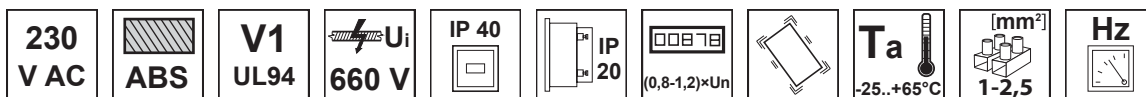

TRACON						C (mm)	D (mm)	
FD-96	96 × 96 mm	×3	45-75 Hz	± 1 %	91 mm	67	8	445 g
FD-72	72 × 72 mm	×3	45-75 Hz	± 1 %	68 mm	70	6	245 g



Instrument je osetljiv i tačan sa mikroprocesorskom komandom, koji meri učestanost mreže. Merena frekvencija se očitava sa LED displeja od 3 digita. Priključivanje napona napajanja se vrši natičnim rednim stezaljkama smeštenim na zadnju ploču naprave.

RELEVANT STANDARD
EN 60051

RELEVANT STANDARD
EN 61010

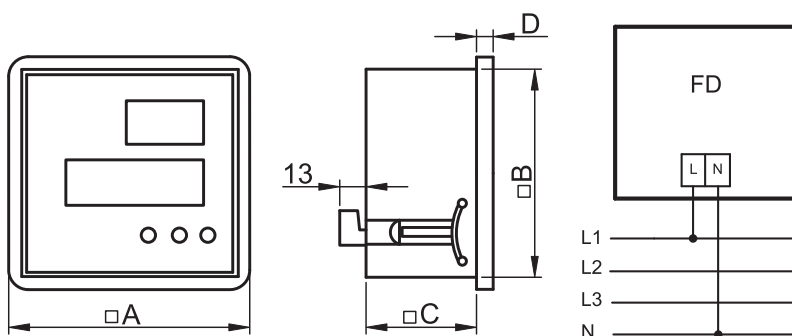

Digitalni cos φ – metar



TRACON						C (mm)	D (mm)	
CFD-96	96×96 mm	×3	0,1-0,99	± 1 %	91 mm	67	8	305 g
CFD-72	72×72 mm	×3	0,1-0,99	± 1 %	68 mm	70	6	250 g



Instrument meri faktor snage neke mreže monofaznog ili trofaznog sistema. Naprava je inteligentna, potpuno je sa mikroprocesorskom komandom. Merena vrednost faktora snage se očitava sa LED displeja instrumenta od 3 digita. Priključivanje napona napajanja se vrši natičnim rednim stezaljkama smeštenim na zadnju ploču naprave. LED –ovke daju informaciju o karakteru cos φ, koje su smeštene na prednju ploču.

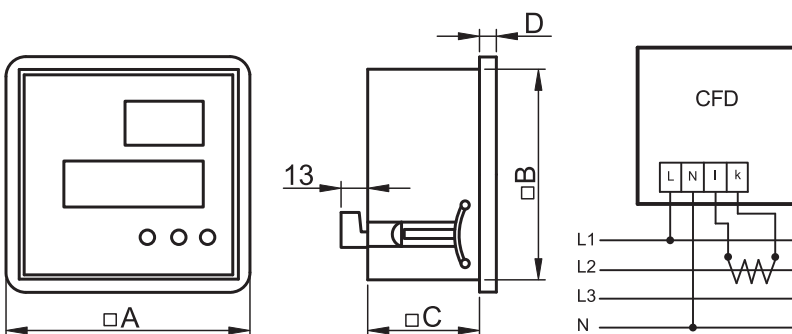

Digitalni multimetri

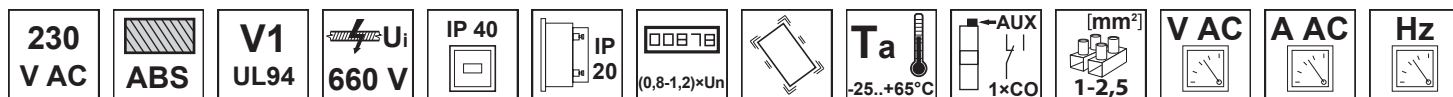

TRACON										
		×digit	L-N	L-L	A	Hz		ha %		m
DTT-2	96 × 96 mm	×4	0-300 V AC	0-500 V AC	0-9500 A AC	40-99,9 Hz	± 1 %	92 mm	470 g	
DTT-3*	96 × 96 mm	×4	0-300 V AC	0-500 V AC	0-9500 A AC	40-99,9 Hz	± 1 %	92 mm	515 g	

* Sa programabilnim rel. izlazom

To su takvi instrumenti sa mikroprocesorom, koji mere mrežnu frekvenciju odnosno aktivne efektivne vrednosti faznih struja i napona sve tri faze (T.R.M.S.). Naprava memoriše minimalne i maksimalne vrednosti struja i napona i iskazuje ih po podešenosti sa strane korisnika. Za tip DTT-3 programabilne su donje i gornje granice napona i sruja, odnosno vreme kašnjenja. Tip DTT-2 je verzija tipa DTT-3 bez relejnog izlaza. Tip

DTT-3 ima dva samostalna relejna izlaza, nazavisna od potencijala, posebno za signalizaciju strujnih i posebno naponskih grešaka. Priključci za napon napajanja i za merenja se ostvarivaju na zadnjoj ploči instrumenta putem natičnih rednih stazaljki. Instrument neposredno iskazuje trenutne vrednosti struja sve tri faze i mrežne frekvencije. Tastaturom na prednjoj ploči se izaberu linijski i fazni naponi, čije trenutne vrednosti se takođe očitavaju sa displeja. Led indikator signalizira izabranu fazu. Izbor strujnog prenosnog odnosa (Ct) se

takođe vrši pomoću tastature, smeštene na prednju ploču.

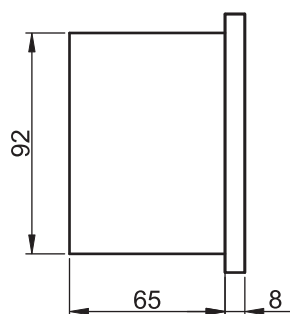
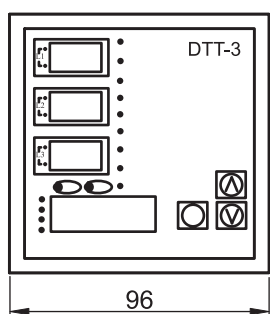
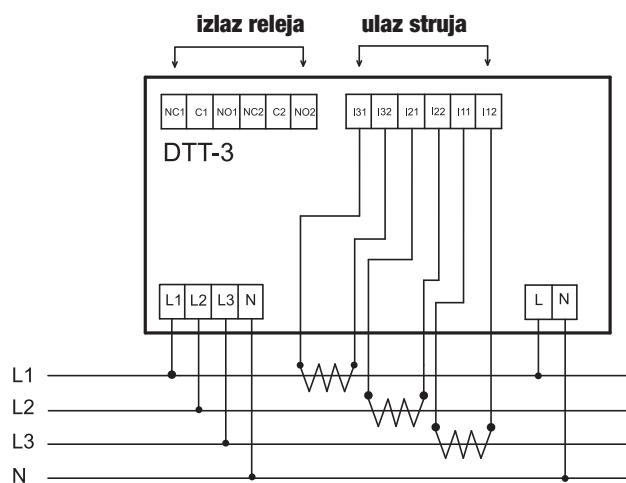
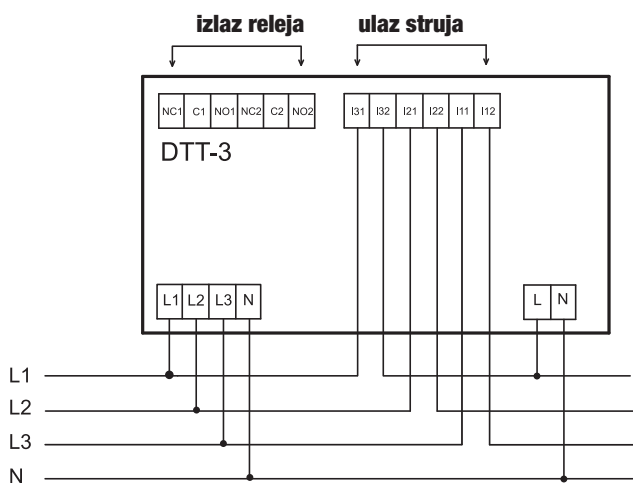

RELEVANT STANDARD
EN 60051

RELEVANT STANDARD
EN 61010



L/26

Inteligentni multimetar za motrenje stanja

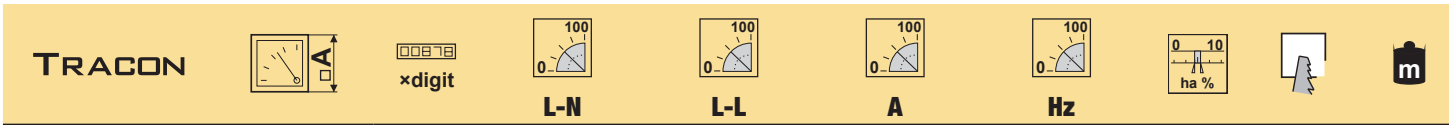
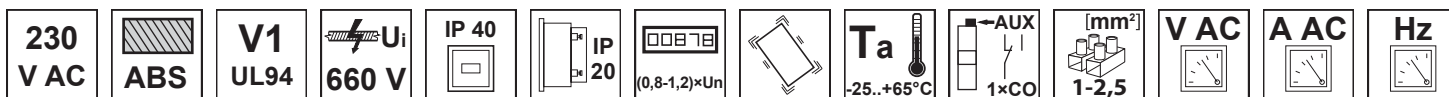

DTT-5 96 × 96 mm ×3 0-280 V AC 0-500 V AC 0-9500 A AC 45-70 Hz ± 0.1 % 92 mm 305 g



**RELEVANT STANDARD
EN 60051**

**RELEVANT STANDARD
EN 61010**

Instrument meri vrednosti struja napona i frekvencije trofazne mreže. Konstruisan je u cilju da pronalazi i saopštava mehaničke i električne greške, koje prete pri radu trofaznih motora. Zahvaljujući tehnologiji detektujućem multimetru otvara se mogućnost pouzdane kontrole sistema, pri kojoj se greške detektuju i otklanjaju pre njihove manifestacije, podsticajući produktivnost kvalitetne proizvodnje. Naprava memoriše merene min/maks vrednosti struja, i po želji ih prikazuje. Pored navedenih, instrument raspolaže sa podešljivim gornjim i donjim nivoom strujne i naponske zaštite, podešljivim vremenskim kašnjenjem, odnosno na izlazu sa izborom prioriteta alarmiranja. Instrument vrši upoređivanje trenutnih i memorisanih referentnih vrednosti merenih veličina, i uzimanjem u obzir veličine eventualnih odstupanja postepeno aktivira pojedine nivoe alarmiranja. Alarmni izlaz instrumenta je preklopnik, nezavisan od potencijala, koji se aktivira podjednako na strujnu ili naponsku grešku. Programabilnim relejnim izlazom se može zadati, da prilikom podešene vrednosti strujne ili naponske greške alarmni izlaz pri kojem nivou prioriteta vrši promenu stanja. Priključenje napona napajanja i naponskih ulaza se vrši pomoću natičnih rednih stezaljki, smeštenih na poledini instrumenta. O trenutnim merenim vrednostima se informiše korisnik putem LED displeja od 3 digita, smeštenog na prednjoj ploči. Izabranu veličinu signalizira LED indikator. Strujni prenos (Ct) se podešava tastaturom, smeštenom na prednjoj ploči instrumenta.

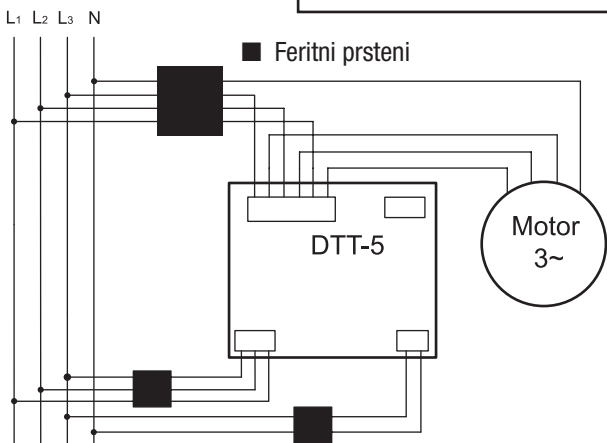

Bez upotrebe strujnih transformatora

Priklučne vodove treba prevesti kroz feritnih prstena, na označen način na slici, radi filtriranja elektromagnetnih smetnji.

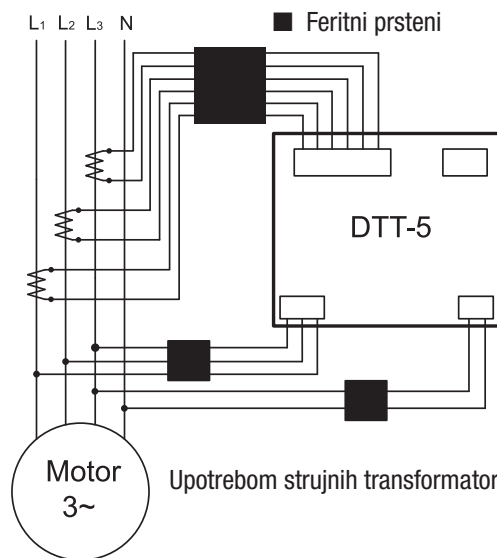

Upotrebom strujnih transformatora



L/26

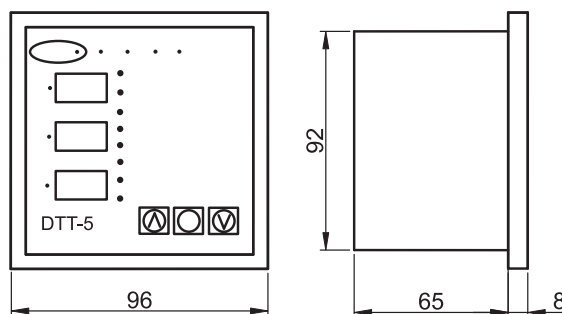

Mrežni analizator

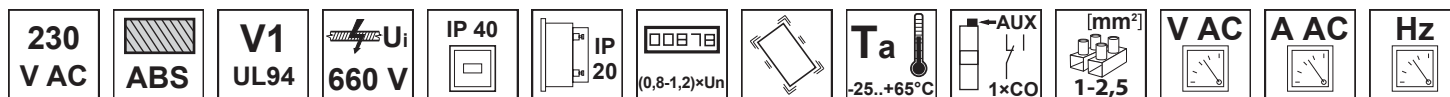

TRACON										
DTT-4	96 × 96 mm	×3/7	0-280 V AC	0-500 V AC	0-9500 A AC	45-70 Hz	± 1 %	± 2 %	92 mm	500 g

Instrument je idealan za merenje, kontrolu i signalizaciju (pogrešnih) parametara mono – i trofaznih mreža. To su struje, fazni i linijski naponi, frekvencija, faktor snage, korisna i jalova snaga odnosno energija. Dobija se slika i o sadržaju viših harmonika struja i napona u mreži. Instrument je pogodan za merenje 75 različitih veličina, čije vrednosti se prikazivaju na 4 LED displeja. Naprava meri realne efektivne vrednosti veličina (T.R.M.S.), ima dva programabilna relejna izlaza, nezavisna od potencijala, koji menjaju stanje prilikom alarmiranja, shodno podešenim granničnim vrednostima sa strane korisnika. Izabranu količinu signalizira LED indikator. Priključenje napona napajanja i naponskih ulaza se vrši pomoću natičnih rednih stezaljki, smeštenih na poledini instrumenta. Strujni prenos (Ct), program i izbor prikaza merenih veličina se podešava tastaturom, smeštenom na prednjoj ploči instrumenta. Instrument je potpuno automatizovan, njegova upotreba je korisna svugde, gde se pored merenja električnih veličina prioritetan je zadatak i kontrola kvaliteta snabdevanja električnom energijom.

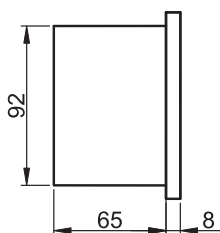
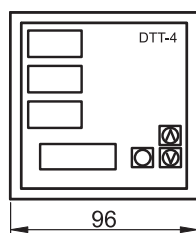

RELEVANT STANDARD
EN 60051

RELEVANT STANDARD
EN 61010

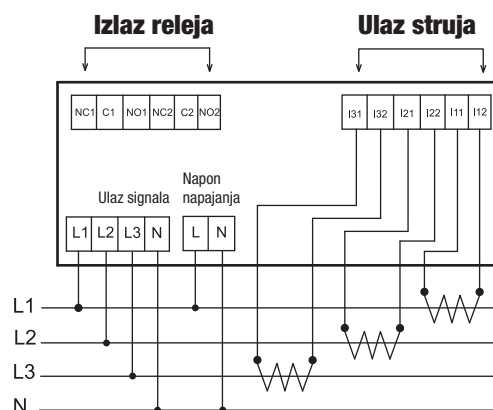

Oznaka	Merena veličina	Alarm	Potpun	L1	L2	L3
VLN	Fazni napon (V)	✓	✓ (*)	✓	✓	✓
VLL	Linijski napon (V)	✓	✓ (*)	✓	✓	✓
I	Fazna struja (A)	✓	✓	✓	✓	✓
FRQ	Frekvencija (Hz)	–	–	✓	–	–
PF	Faktor snage (cos φ.)	–	✓ (*)	✓	✓	✓
kW	Korisna snaga (kW)	✓	✓	✓	✓	✓
kVAr	Jalova snaga (kVAr)	✓	✓	✓	✓	✓
kVA	Prividna snaga (kVA)	✓	✓	✓	✓	✓
kWh	Korisna energija (kWh)	–	✓	–	–	–
kVArh.IND	Induktivna jalova energija (kVArh)	–	✓	–	–	–
kVArh.CAP	Kapacitivna jalova energija (kVArh)	–	✓	–	–	–
kVAh	Prividna energija (kVAh)	–	✓	–	–	–
V _{THD}	Faktor torzije harmonika punog napona (%)	–	–	✓	✓	✓
V _{3 ... V₁₃}	Neparni harmonici napona (do 13.) (%)	–	–	✓	✓	✓
I _{THD}	Faktor torzije harmonika pune struje (%)	–	–	✓	✓	✓
I _{3 ... I₁₃}	Neparni harmonici struje (do 13.) (%)	–	–	✓	✓	✓

* Instrument pokazuje prosečnu veličinu merenih vrednosti na tri faze.

Brojila, monofazna

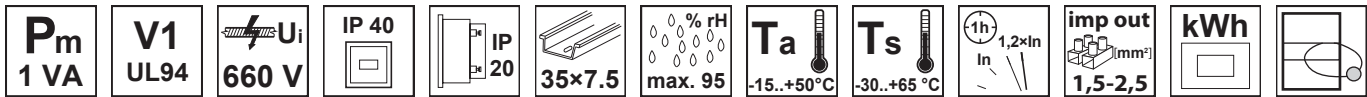

TRACON		U_n	I_b (I_{max})	T_a	imp/kWh S0	ha %	mm^2		m	
TV0-F1M2	DIRECT → kWh	010114	220-240 V AC	20 (60) A	80 mA-60 A	1.600	2	25	16	200 g
TV0-F1MV	DIRECT → kWh	010114	220-240 V AC	5 (30) A	20 mA-30 A	1.000	2	6	6	80 g
TV0-F1V	DIRECT → kWh	00978	220-240 V AC	5 (32) A	20 mA-32 A	1.000	2	6	6	80 g
TV0-F1M-04	DIRECT → kWh	010114	220-240 V AC	5 (45) A	20 mA-45 A	1.000	1	6	6	120 g

TV0-F1M2

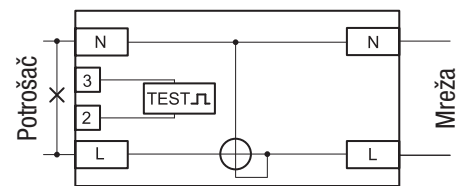
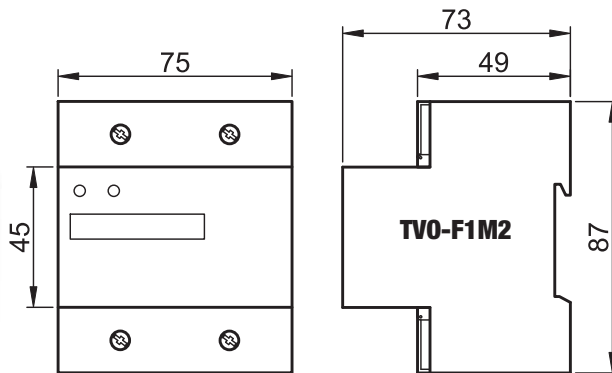

TV0-F1V

TV0-F1MV



imp/kWh S0	U_n	L_{imp}	I_n
	min. 18 V, max. 27 V	>30 ms	max. 27 mA

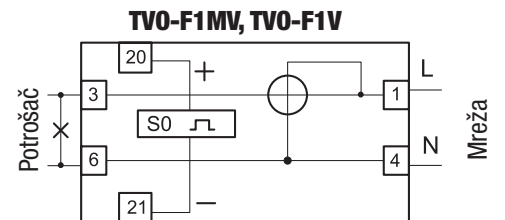
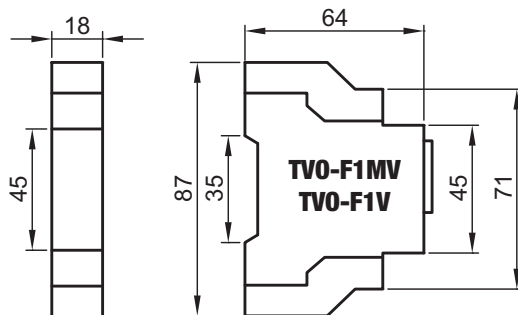

TV0-F1M-04

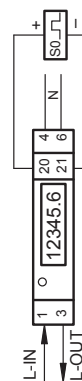
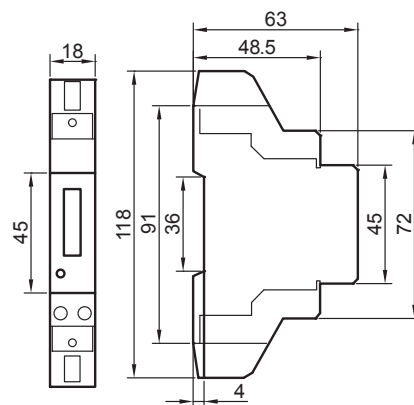

imp/kWh S0	U_n	L_{imp}	I_n
	min. 12 V, max. 27 V	>30 ms	max. 27 mA

RELEVANT STANDARD
EN 62053

RELEVANT STANDARD
IEC 61036

Brojila, monofazna

P_m 1 VA	V1 UL94	U_i 660 V	IP 40	IP 20	35×7.5	% rH max. 95	T_a -10...+50 °C	T_s -30...+65 °C	1h In 1,2×In	imp out [mm ²] 1,5-2,5	kWh	
------------------------------	-------------------	-------------------------------	--------------	--------------	---------------	------------------------	--------------------------------------	--------------------------------------	------------------------	---	------------	--

TRACON	U_n	I_b (I _{max})		imp/kWh S0			
---------------	----------------------	---	--	-----------------------------	--	--	--

TV0-F1-CT CT kWh 220-240 V AC 5A/CT 0,002lp-lp 6.400 1 16 10 260 g

I_p – primarna struja mernog transformatora
CT – strujni merni transformator

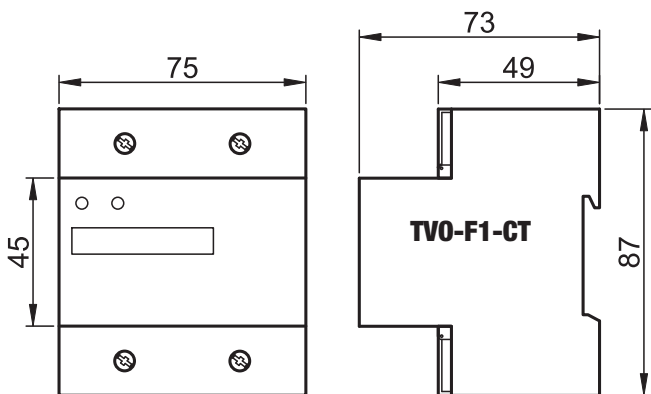

**RELEVANT STANDARD
IEC 61036**

**RELEVANT STANDARD
EN 62053**

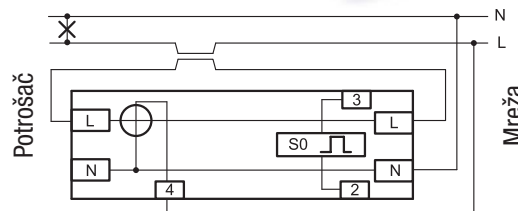

imp/kWh S0	U_n min. 18 V, max. 27 V	L_{imp} >30 ms	I_n max. 27 mA
-----------------------------	--	----------------------------------	------------------------------------

Monofazna brojila potrošnje pomoću prevedenog provodnika

P_m 1 VA	V1 UL94	U_i 660 V	IP 40	IP 20	35×7.5	% rH max. 95	T_a -10...+50 °C	T_s -30...+65 °C	1h In 1,2×In	imp out [mm ²] 1,5-2,5	kWh	
------------------------------	-------------------	-------------------------------	--------------	--------------	---------------	------------------------	--------------------------------------	--------------------------------------	------------------------	---	------------	--

TRACON	U_n	I_b (I _{max})		imp/kWh S0			
---------------	----------------------	---	--	-----------------------------	--	--	--

TV0-F1-WT DIRECT kWh 220-240 V AC 30 (100) A 80 mA-100 A 800 1 25 16 200 g

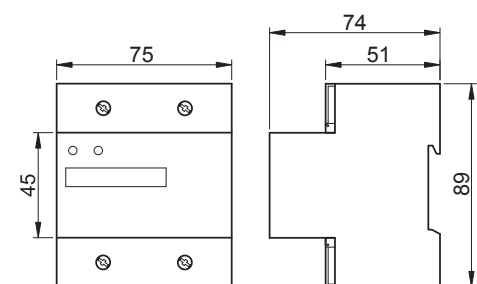

Provodnik tu treba prevezati kroz prozorčić, posle kontakt se ostvaruje stezanjem vijka, koji preseca izolaciju. Za provodnike malog preseka se prilazke reducir prsten.

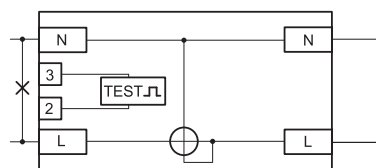

imp/kWh S0	U_n min. 18 V, max. 27 V	L_{imp} >30 ms	I_n max. 27 mA
-----------------------------	--	----------------------------------	------------------------------------

**RELEVANT STANDARD
IEC 61036**



Brojila, trofazna

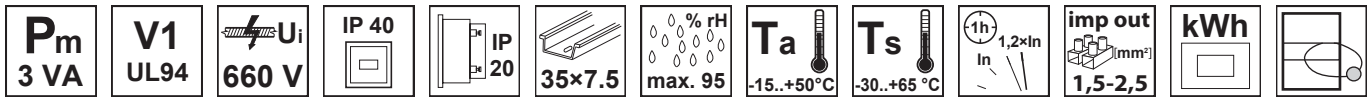

TRACON	U_n	I_b (I_{max})		imp/kWh S_0		mm^2	
TV0-F3-4MCT CT kWh	3x230/400 V	5A/CT	0,002lp-lp	1.600	1	16 10	370 g
TV0-F3-4M DIRECT kWh	3x230/400 V	10 (100) A*	80 mA-100 A	200	2	25 16	450 g

* po fazi

I_p – primarna struja mernog transformatora
CT – strujni merni transformator

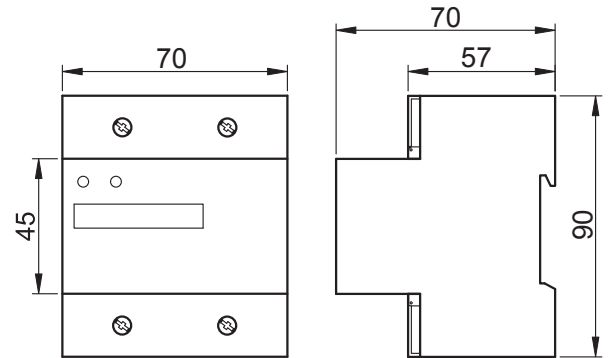

TV0-F3-4MCT

TV0-F3-4M

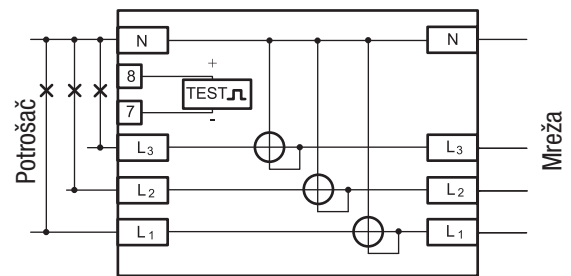
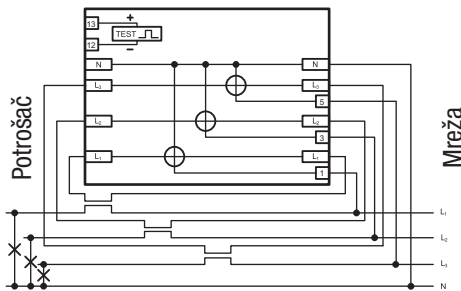

RELEVANT STANDARD
IEC 61036

RELEVANT STANDARD
EN 62053

imp/kWh
 S_0

U_n
min. 18 V, max. 27 V

L_{imp}

I_n

>30 ms max. 27 mA

Digitalna brojila sa utakanjem

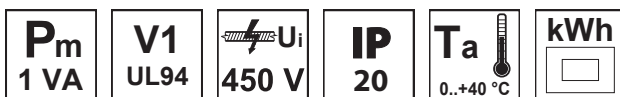

TRACON	U_n	I_n		P_{max}		
TV0-1D216F DIRECT kWh	230 V AC	16 A	2	3.600 W	3x357 A	200 g

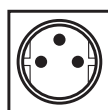

Brojilo tipa TV0-1D216F.. je pouzdan aparat, koji na LCD displeju prikazuje potrošnju priključenog (priključenih) potrošača u svoju utičnicu u kWh, kao i novčani iznos potrošene električne energije.

- Alarm preopterećenja
- Prikaz pikova struje i snage
- Vreme trajanja potrošnje el. energije
- Sat
- Prikaz novčanog iznosa potrošnje

RELEVANT STANDARD
EN 62053

Automatika za popravku faze, sa 3f komandom po fazi

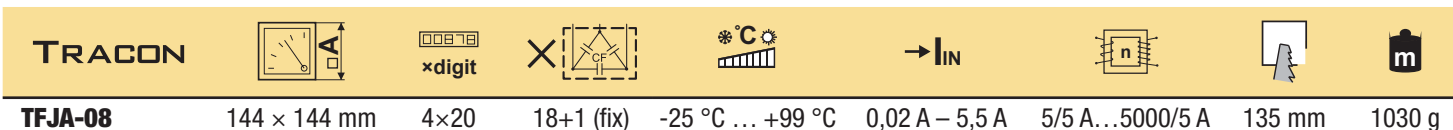
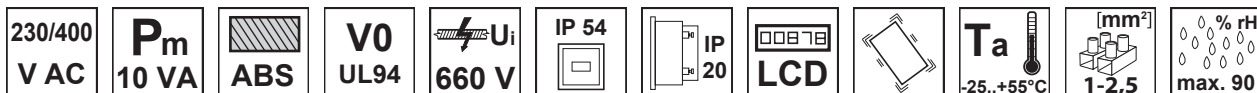

RELEVANT STANDARD
EN 60051

RELEVANT STANDARD
EN 61010

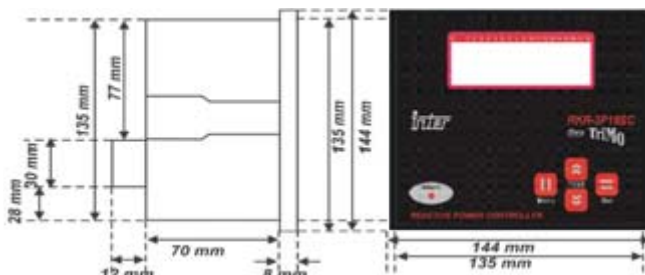

Ovo su regulatori snage na osnovu takvih Hi-Tech mikroprocesora, koji imaju LCD displej, i pokreću 7 ili 12 kondenzatorskih blokova. Ovi regulatori mere parametre mreže u sve tri faze i na osnovu toga se vrši komanda. U automatskom režimu rada možemo dobiti informaciju o uključenom stanju stepena, vrednosti vrste faktora snage. U ručnom režimu imamo mogućnost za merenje faktora snage po fazama, struju i napon, odnosno sadržaj gornjeg harmonika za sve tri faze; merenje efektivne, kapacitivne i induktivne jalove snage mreže, odnosno na ukuljučenje ili isključenje raznih stepena. Regulator vrši uključenje i isključenje kondenzatorskih blokova u automatskom režimu na osnovu podešene snage kondenzatora, i podešenih parametara. Komandni proces vrši uključenje i isključenje raznih stepena na po kompleksnom algoritmu na osnovu vrednosti i vrste faktora snage, a pri tom maksimalno produžuje vek trajanja kondenzatorskih blokova, i pripadajućim kontaktorima. Uređaj poseduje alarmni izlaz nezavisnog potencijala, koji se može programirati pomoću tastera koji se nalazi na uređaju.

- LCD displej sa 4 reda, 20 karaktera po redu
- Ručni/automatski režim rada
- Podesivost: $\cos\phi$ 0,8 ind- 0,8 cap
- Podesiva zaštita od pregrevanja
- Podesiva zaštita od gornjeg harmonika
- Merenje napona i struje do 21-gornjeg harmonika
- Alarmi, pomoću alarmnog izlaza
- 3f regulacija po fazama
- Automatsko prepoznavanje vrste opterećenja
- U-/isključenje sa zakašnjenjem
- Podesiva prenaponska zaštita
- Indikator svih gornjih harmonika
- Indikator napona, struje, i snage
- Zaštita sa lozinkom

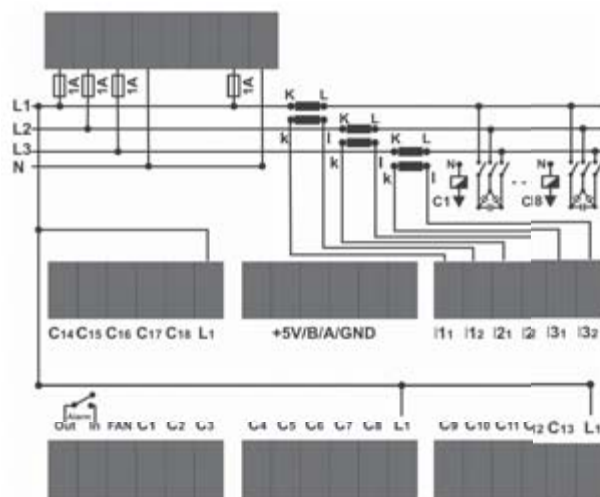

USB-485 konverter za TFJA-08

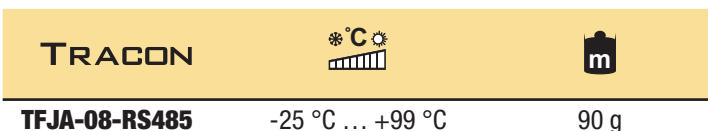
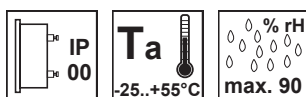

Monofazni merni regulatori

230 V AC	ABS	V0 UL94	U_i 660 V	IP 54	IP 20	LCD	Ta -25...+55°C	[mm ²] 1-2,5	Objašnjenje piktograma	L/O
-------------	-----	------------	----------------	-------	-------	-----	-------------------	-----------------------------	---------------------------	-----

TRACON					I_{IN}			
TFJA-01	144 × 144 mm	2×16	7+1 (fix)	-25 °C ... +99 °C	0,02 A – 5,5 A	5/5 A...5000/5 A	135 mm	1000 g
TFJA-02	144 × 144 mm	2×16	12+1 (fix)	-25 °C ... +99 °C	0,02 A – 5,5 A	5/5 A...5000/5 A	135 mm	1050 g



RELEVANT STANDARD
EN 60051

RELEVANT STANDARD
EN 61010

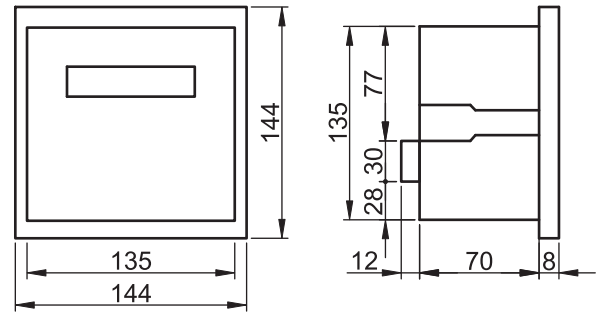

Ovi regulatori snaga imaju Hi-Tech mikroprocesor i digitalni LCD displej. Vrše komandovanje 7 ili 12 kom kondenzatorskih baterija. Ovi regulatori mere mrežne parametre samo u jednoj fazi i po tome se dešava intervencija. Na displeju se signalise vrednost i karakter faktora snage, fazni napon i struja, viši harmonici temperatura i broj uključenih jedinica kondenzatora. U manualnom režimu rada postoji mogućnost komandovanja pojedinih jedinica sa strane korisnika istih.

Tokom procesa testiranja broj priključenih jedinica i dotične jalove snage se određuju automatski. U automatskom režimu rada regulator vrši u – i isključivanje kondenzatorskih baterija shodno potrebnim kondenzatorskim snagama i podešenim parametrima. Proces regulacije deluje na osnovu kompleksnog algoritma po željenoj vrednosti i karaktera faktora snage, uz maksimalno čuvanje veka trajanja kondenzatorskih baterija i kontaktora za njihovo komandovanje.

Naprava je opremljena jednim alarmnim izlazom, nezavisnim od potencijala, i programabilnim pomoću tastature smeštene na prednju ploču. Izlaz hlađenja se aktivira shodno podešenim i u memoriji instrumenta sačuvanim graničnim vrednostima pri rasta temperature baterija. Aktivno stanje alarmnog izlaza signalise LED na prednjoj ploči naprave.

Glavne funkcije

- Faktor snage (cos φ) podešljiv između 0,8 ind. – 1,0 kapac.;
- automatski manualni režim rada;
- tačna kalkulacija početne kondenzatorske snage;
- automatsko podešavanje granične vrednosti struja (C/k vrednost);
- automatsko prepoznavanje polariteta na priključcima strujnog prenosa(k-l);
- podešljiva granica pregrevanja i prenapona;
- podešljiva granica zaštite od prenapona i viših harmonika;
- podešljivo vreme u – i isključivanja kondenzatora;
- kontrola merenje i signalizacija viših harmonika;
- identifikacija pojedinih alarma na displeju

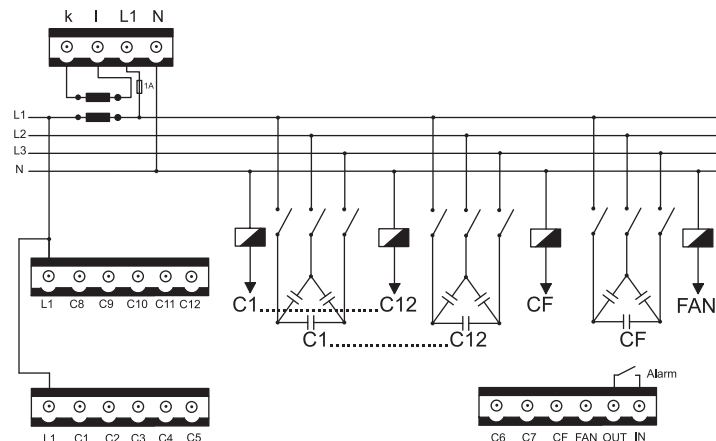

Trofazni merni regulatori

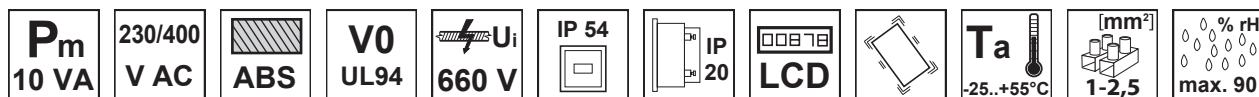

TRACON								
TFJA-03	144 × 144 mm	2×16	7+1 (fix)	-25 °C ... +99 °C	0,02 A – 5,5 A	5/5 A...5000/5 A	135 mm	1030 g
TFJA-04	144 × 144 mm	2×16	12+1 (fix)	-25 °C ... +99 °C	0,02 A – 5,5 A	5/5 A...5000/5 A	135 mm	1030 g

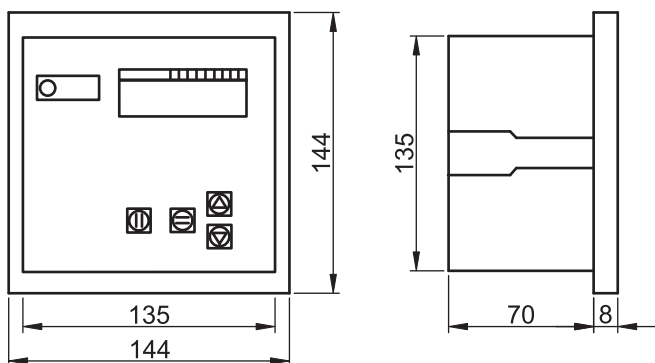

RELEVANT STANDARD
EN 60051

RELEVANT STANDARD
EN 61010



Ovi regulatori snaga imaju Hi-Tech mikroprocesor i digitalni LCD displej. Vrše komandovanje 7 ili 12 kom kondenzatorskih baterija. Ovi regulatori mere mrežne parametre sve tri faze i po tome se dešava intervencija. Merenje veličina ima nivo analizatorski, i kondenzatorska snaga je podešljiva međusobno nezavisno.

U manualnom režimu rada postoji mogućnost komandovanja pojedinih jedinica sa strane korisnika istih. U automatskom režimu rada regulator vrši – i isključivanje kondenzatorskih baterija shodno potrebnim kondenzatorskim snagama i podešenim parametrima. Proces regulacije deluje na osnovu kompleksnog algoritma po željenoj vrednosti i karaktera faktora snage, uz maksimalno čuvanje veka trajanja kondenzatorskih baterija i kontaktora za njihovo komandovanje.

Naprava je opremljena jednim alarmnim izlazom, nezavisnim od potencijala, i programabilnim pomoću tastature smeštene na prednju ploču. Izlaz hlađenja se aktivira shodno podešenim i u memoriji instrumenta sačuvanim graničnim vrednostima pri rasta temperature baterija. Aktivno stanje alarmnog izlaza signalise LED na prednjoj ploči naprave.

Glavne funkcije

- Faktor snage ($\cos \varphi$) podešljiv između 0,8 ind. – 0,9 kapac.;
- automatski manualni režim rada;
- međusobno nezavisna podešljivost snaga kondenzatora po stepenima
- Automatsko detektovanje struje;
- Podešljiva prenaponska granica;
- Podešljiva granica pregrevanja;
- Podešljiva visoka granica viših harmonika;
- Podešljivo vremensko kašnjenje kondenzatora;
- Podešljivi zaštitni nivo napona viših harmonika (V_{THD} ; V_3 ; $V_5 \dots V_{13}$);
- Podešljivi zaštitni nivo struja viših harmonika (I_{THD} ; I_3 ; $I_5 \dots I_{13}$);
- Režim kondenzatorskog testa;

- Merenje aktivne; induktivne i kapacitivne potrošnje energije;
- Kontrola THD napona; struje; $\cos \varphi$; (potpuna torzija harmonika) u svim fazama;
- Kontrola kondenzatorske snage; temperature; frekvencije; i potpunog faktora snage;
- Alarmiranje u slučaju visokog napona, visoke temperature, visokog odnosa reaktivne i aktivne snage i visokog procenta viših harmonika, sa zakašnjenjem

C/k podešavanje: automatsko, manualno
 Polarizacija strujnog prenosa: automatska
 A/D pretvarač: 10 bit
 Učestalost vađenja uzoraka: 64 uzorka / period
 Izlaz kontakt/alarm: 250 V/5 A AC

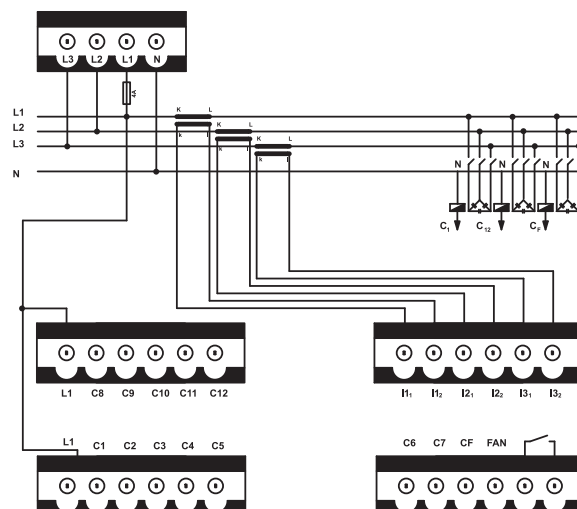

Regulatori sa automatskim ili ručnim režimom rada

230 V AC	ABS	V0 UL94	U_i 660 V	IP 54	IP 20	LCD	Ta -25...+55°C	[mm ²] 1-2,5	Objašnjenje piktograma	L/O
-------------	-----	------------	----------------	-------	-------	-----	-------------------	-----------------------------	---------------------------	-----

TRACON								
TFJA-05	144 × 144 mm	3×7	5+1 (fix)	-25 °C ... +99 °C	0,02 A – 5,5 A	5/5 A...5000/5 A	92 mm	1000 g
TFJA-06	96 × 96 mm	3×7	7+1 (fix)	-25 °C ... +99 °C	0,02 A – 5,5 A	5/5 A...5000/5 A	135 mm	600 g

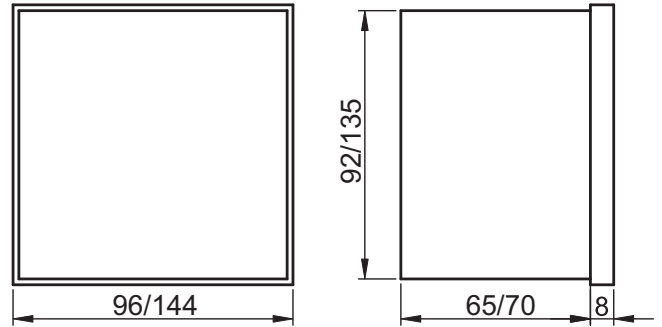

Ove naprave su regulatori na bazi mikroprocesora i LED displejem a pogodne su komandovanje 5 ili 7 kondenzatorskih baterija/grupa. Samo u jednoj fazi mere parametre mreže i po tome se dešavaju intervencije. Uklop ili isklup kondenzatora je u skladu sa ranije određenom punom jalovom snagom i sa merenim snagama kondenzatora. U ručnom režimu rada ima mogućnost za u – i isključivanje pojedinih stepena od strane korisnika istih. Proces regulacije deluje na osnovu kompleksnog algoritma po željenoj vrednosti i karaktera faktora snage, uz maksimalno čuvanje veka trajanja kondenzatorskih baterija i kontaktora za njihovo komandovanje. Naprava je opremljena jednim alarmnim izlazom, nezavisnim od potencijala, i programabilnim pomoću tastature smeštene na prednju ploču. Alarmni izlaz i uključeno stanje pojedinih stepena, režim rada regulatora, signalisanu veličinu, i karakter opterećenja pokazuju svetlosni signali LED smeštene na prednjoj ploči.

Glavne funkcije

- Displej od 7 segmenata;
- Podešljiv faktor snage($\cos \varphi$) između 0,8. – 1,0;
- Automatski i ručni režim rada;
- Merenje snage kondenzatora;
- Automatsko C/k podešavanje;
- Automatsko određivanje smera struje;
- Prekonaponska zaštita preko alarmnog izlaza;
- Podešljivo vreme u-/isključivanja kondenzatora;
- Prikazivanje vrednosti napona i $\cos \varphi$;
- U slučaju alarma signalizacija grešaka se vrši putem LED;

C/k podešavanje: automatski
 Polarizacija strujnog prenosa: automatski
 Dozvoljena struja kontaktnog izlaza: 250 V/5 A AC (TFJA-05),
 250 V/3 A AC (TFJA-06)
 Dozvoljena struja alarmnog izlaza: 250 V/5 A AC (TFJA-05),
 250 V/3 A AC (TFJA-06)

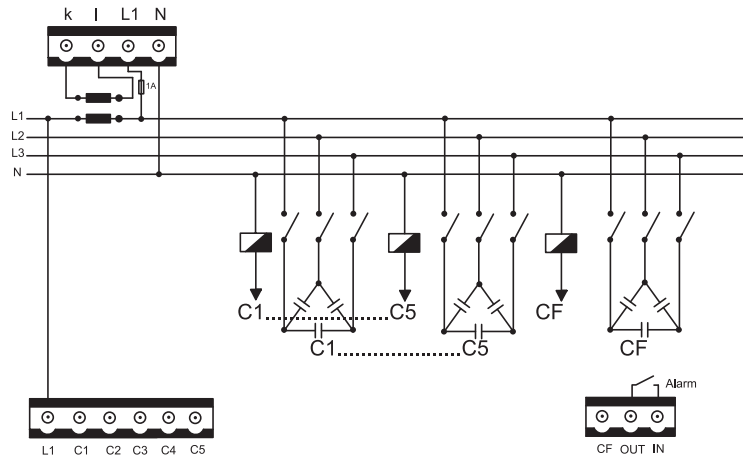

RELEVANT STANDARD
EN 60051

RELEVANT STANDARD
EN 61010



Učitajte šifru!

- Pogledajte naše novosti
- Budite savremeni

Naš asortiman se brzo i kontinuirano proširuje!
 Katalog predstavlja stanje od oktobra 2017.
 Za sveže informacije, posetite naš sajt!

Regulatori sa automatskim režimom rada

230 V AC	ABS	V0 UL94	U_i 660 V	IP 30	IP 20	LCD	T_a -25...+55°C	[mm ²] 1-2,5	Objašnjenje piktograma	L/O
TRACON		xdigit								
TFJA-07	144 × 144 mm	3×7	5	-25 °C ... +99 °C	5/5 A...5000/5 A	1 %	135 mm	1.200 g		

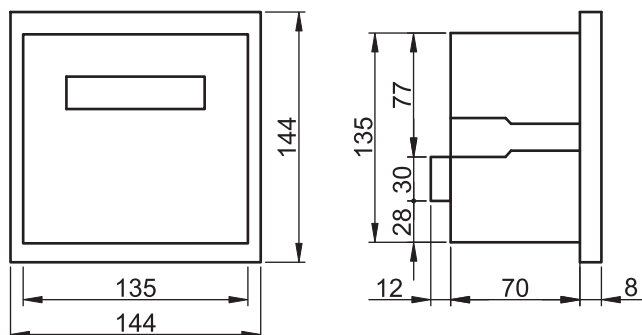

Regulator jalove snage tipa TFJA-07 je potpuno automatizovan, i na svom panelu nema tastature za podešavanje. Intervencija se vrši na osnovu merene vrednosti napona i struje jedne faze. naprava priključuje pet kondenzatorskih baterija na mrežu na osnovu regulacionog algoritma mikroprocesora, ukoliko faktor snage opadne ispod 0,95. Vremensko kašnjenje uključivanja kondenzatorskih baterija je 14 sekundi a isključivanja je 5 sekundi. U neopterećenom stanju ili pri minimalnom opterećenju, kada vrednost $\cos \varphi$ izvan opsega 0,95 do 1, prvi kondenzatorski stepen će funkcionisati kao džoker kondenzator. Na prvi stepen treba priključiti kondenzatorsku bateriju najmanje kapacitivnosti. Proces regulacije deluje na osnovu kompleksnog algoritma po željenoj vrednosti i karaktera faktora snage, uz maksimalno čuvanje veka trajanja kondenzatorskih baterija i kontaktora za njihovo komandovanje. Vrednost faktora snage se očitava sa LED displeja od 3 digita na prednjoj ploči naprave. O broju uključenih stepeni i karakteru faktora snage (induktivan/kapacitivan) Led indikatori daju informacije. Raspored kondenzatorskih snaga na pojedine stepene je vršen po donjoj tabeli.

Kondenzatorski izlazi	1. stepen	2. stepen	3. stepen	4. stepen	5. stepen
Kondenzatorska snaga	1 -1,5 kVAr	2,5 kVAr	5 kVAr	10 kVAr	20 kVAr

Voltmetarski ulaz: L1, N
 Učestalost vađenja uzoraka: 64 uzorka / period
 Ampermetarski ulaz: k, l
 Opterećenje ampermetarskog ulaza: maks. 7 A trajno, 20 A / 1 sec.
 Opteretljivost strujnog izlaza: 250 V/5 A AC

RELEVANT STANDARD
EN 60051

RELEVANT STANDARD
EN 61010

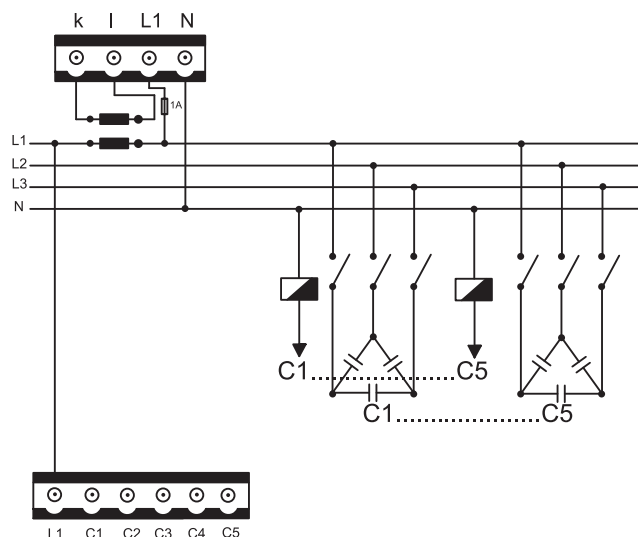

Niskonaponski strujni merni transformatori

Sa njihovom primenom se može proširiti merni opseg analognih ili digitalnih ampermetara naizmenične struje u oblasti struje 5-3000 A, a pomoću njih se može povećati opteretljivost strujnih kalema $\cos\phi$ -metara, brojila, mrežnih analizatora, multimetara ili regulatora jalove snage, ako su priključeni na sekundar strujnog transformatora.

Strujni transformatori se sastoje od jednog primarnog namota, jednog sekundarnog namota odnosno feromagnetnog jezgra. Primarni namot je ili jedan namot u kućištu, ili postavljen kabel odn. šina kroz jezgro. U slučaju ugrađenog primara odnosno prevezanog kabela strujni transformator treba posebno fiksirati pomoću priloženog kompleta za tu namenu. Kod izvedbi sa ugrađenom šinom, fiksiranje se vrši neposredno na šini. Strana P1 primara strujnog transformatora je priključena na mrežu, a strana P2 na potrošač. Stezaljke sekundara S1 i S2 su priključeni neposredno na odgovarajući ulaz instrumenta.

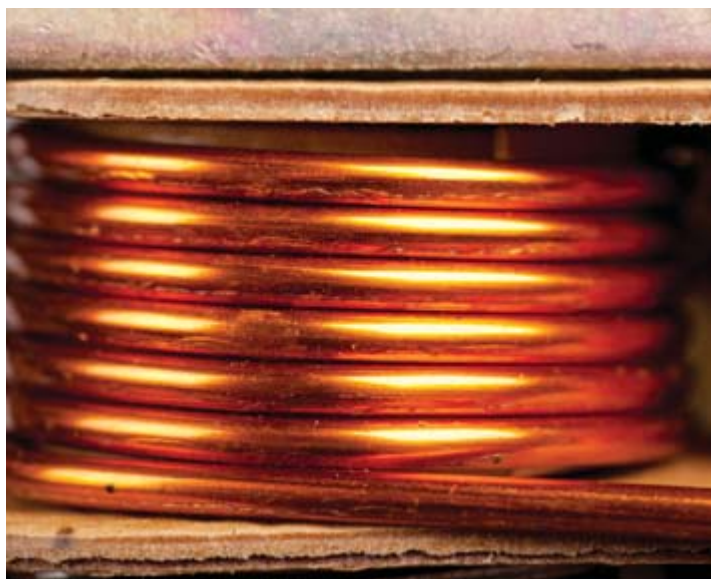

AVBS (5/5A-150/5A)

660 V AC	VO UL94	U_i 720 V	U_{test} 1min 3 kV	F_s security 5	I_{th} 1,2× I_n	T_a -5...+45 °C	I_{th} 50× I_n	I_{din} 2,5× I_{th}	Objašnjenje piktograma	L/O
-------------	------------	----------------	----------------------------	------------------------	---------------------	----------------------	-----------------------	----------------------------	------------------------	-----

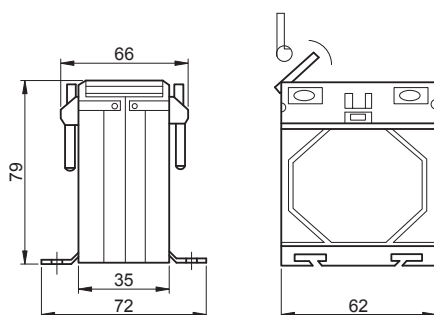

RELEVANT STANDARD
EN 61010

TRACON		P_s	0 10 ha %	m
AVBS-5	5/5 A	2,5 VA	0,5	370 g
AVBS-15	15/5 A	2,5 VA	0,5	380 g
AVBS-30	30/5 A	2,5 VA	0,5	400 g
AVBS-50	50/5 A	2,5 VA	0,5	420 g
AVBS-60	60/5 A	2,5 VA	0,5	430 g
AVBS-75	75/5 A	2,5 VA	0,5	450 g
AVBS-100	100/5 A	2,5 VA	0,5	480 g
AVBS-150	150/5 A	2,5 VA	0,5	510 g

izvedbe sa ugrađenom primarnom šinom

AV30..SH (50/5A-200/5A)

660 V AC	VO UL94	U_i 720 V	U_{test} 1min 3 kV	F_s security 5	I_{th} 1,2× I_n	T_a -5...+45 °C	I_{th} 100× I_n	I_{din} 2,5× I_{th}
-------------	------------	----------------	----------------------------	------------------------	---------------------	----------------------	------------------------	----------------------------

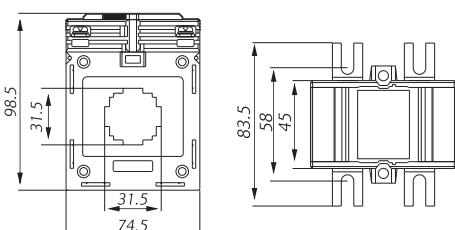

TRACON		P_s	0 10 ha %	m
AV3060SH	60/5 A	1,5 VA	0,5	500 g
AV3075SH	75/5 A	2,5 VA	0,5	500 g
AV30100SH	100/5 A	3,75 VA	0,5	500 g
AV30150SH	150/5 A	5 VA	0,5	500 g
AV30200SH	200/5 A	5 VA	0,5	500 g

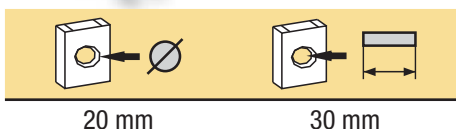

RELEVANT STANDARD
EN 60051

RELEVANT STANDARD
EN 61010

AV40..SH (100/5A-500/5A)

660 V AC	VO UL94	U _i 720 V		U _{test} 1min 3 kV	F _s security 5	1,2×I _n I _n	T _a -5...+45 °C	I _{th} 50×I _n	I _{din} 2,5×I _{th}	Objašnjenje piktograma	L/O
-------------	------------	-------------------------	--	-----------------------------------	---------------------------------	--------------------------------------	-------------------------------	--------------------------------------	---	---------------------------	-----

TRACON		P _s		
AV40100SH	100/5 A	2,5 VA	0,5	500 g
AV40150SH	150/5 A	5 VA	0,5	500 g
AV40200SH	200/5 A	5 VA	0,5	500 g
AV40250SH	250/5 A	5 VA	0,5	500 g
AV40300SH	300/5 A	5 VA	0,5	500 g
AV40400SH	400/5 A	5 VA	0,5	500 g
AV40500SH	500/5 A	5 VA	0,5	500 g

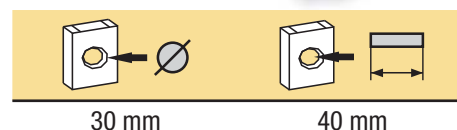
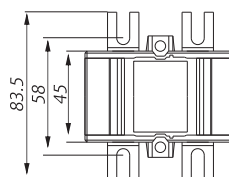
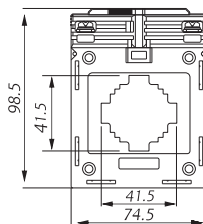

AV60..SH (600/5A-1200/5A)

660 V AC	VO UL94	U _i 720 V		U _{test} 1min 3 kV	F _s security 5	1,2×I _n I _n	T _a -5...+45 °C	I _{th} max. 50kA _{eff}	I _{din} 2,5×I _{th}
-------------	------------	-------------------------	--	-----------------------------------	---------------------------------	--------------------------------------	-------------------------------	---	---

TRACON		P _s		
AV60600SH	600/5 A	15 VA	0,5	450 g
AV60800SH	800/5 A	15 VA	0,5	480 g
AV601000SH	1000/5 A	15 VA	0,5	520 g
AV601200SH	1200/5 A	15 VA	0,5	520 g

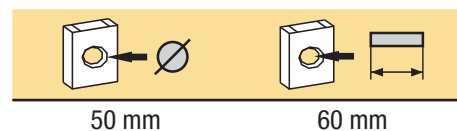
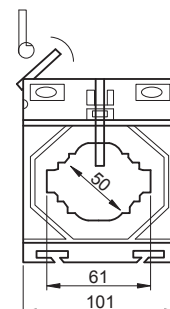
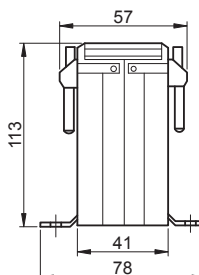

RELEVANT STANDARD
EN 60051

RELEVANT STANDARD
EN 61010

AV100..SH (1200/5A-3000/5A)

660 V AC	VO UL94	U _i 720 V		U _{test} 1min 3 kV	F _s security 5	1,2×I _n I _n	T _a -5...+45 °C	I _{th} max. 50kA _{eff}	I _{din} 2,5×I _{th}
-------------	------------	-------------------------	--	-----------------------------------	---------------------------------	--------------------------------------	-------------------------------	---	---

TRACON		P _s		
AV1001200SH	1200/5 A	15 VA	0,5	690 g
AV1001600SH	1600/5 A	15 VA	0,5	850 g
AV1002000SH	2000/5 A	15 VA	0,5	1.000 g
AV1002500SH	2500/5 A	15 VA	0,5	1.050 g
AV1003000SH	3000/5 A	15 VA	0,5	1.200 g

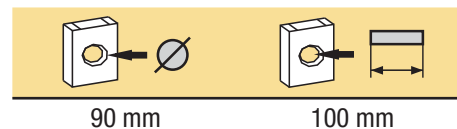
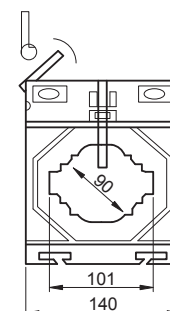
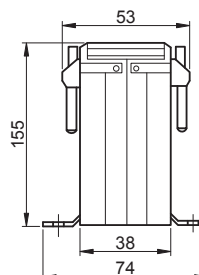

RELEVANT STANDARD
EN 60051

RELEVANT STANDARD
EN 61010

Strujni merni transformatori za baždarenje

Ovi strujni transformatori podležu propisima standarda EN 60044-1 i zadovoljavaju zahteve klase tačnosti 0,5 S.

Ukoliko se ti strujni transformatori žele koristiti za merenje obračunate (tarifne) potrošnje pojedinačno ih treba baždariti u nacionalnom zavodu za kontrolu mera ili akreditovnim etalon laboratorijama.

Pošto strujni transformatori tipa MKEH-MH (nekadašnji OMH) su baždareni, zato se mogu primeniti za merenja tarifiranog karaktera, radi overenog obračuna.

S obzirom na to, njihovu ugradnju prihvataju i elektrodistribucije.

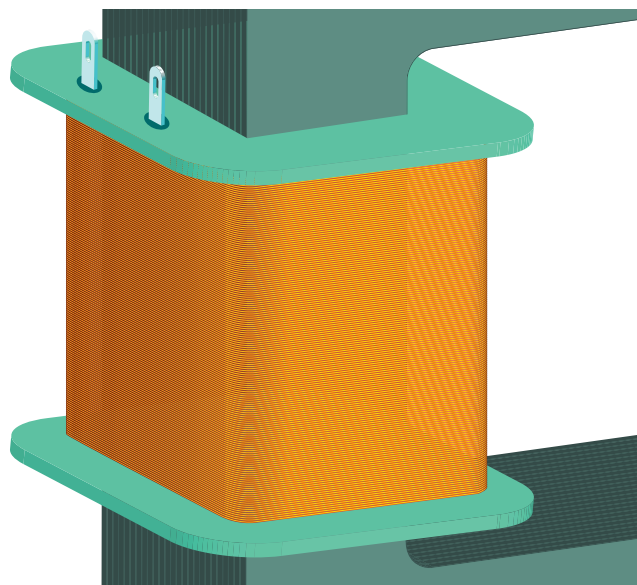

RELEVANT STANDARD
EN 60051

RELEVANT STANDARD
EN 61010

EPSA30 (150/5A-400/5A) 1,5 VA

660 V AC	MKEH -MH	U_i 720 V		Utest 1min 3 kV	Fs security 5	I_n 1,2x I_n	Ta -5...+45 °C	I _{th} 60xI _n	I _{din} 2,5xI _{th}	Objašnjenje piktograma	L/O
-------------	-------------	----------------	--	-----------------------	---------------------	------------------	-------------------	--------------------------------------	---	---------------------------	-----

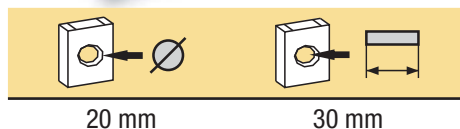
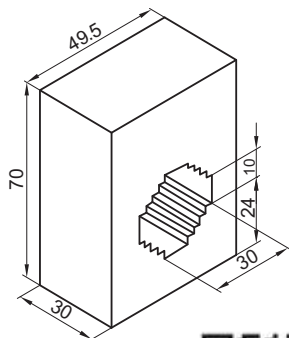

TRACON		P _s		
EPSA30150-1,5	150/5 A	1,5 VA	0,5S	300 g
EPSA30200-1,5	200/5 A	1,5 VA	0,5S	300 g
EPSA30250-1,5	250/5 A	1,5 VA	0,5S	300 g
EPSA30300-1,5	300/5 A	1,5 VA	0,5S	300 g
EPSA30400-1,5	400/5 A	1,5 VA	0,5S	300 g

RELEVANT STANDARD
EN 60051

RELEVANT STANDARD
EN 61010

EPSA30 (150/5A-500/5A) 2,5 VA

660 V AC	MKEH -MH	U_i 720 V		Utest 1min 3 kV	Fs security 5	I_n 1,2x I_n	Ta -5...+45 °C	I _{th} 60xI _n	I _{din} 2,5xI _{th}
-------------	-------------	----------------	--	-----------------------	---------------------	------------------	-------------------	--------------------------------------	---

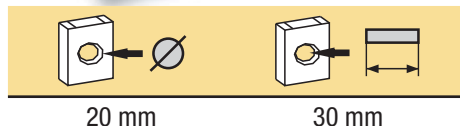
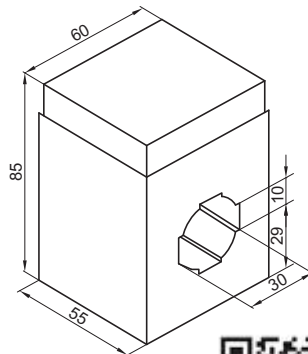

TRACON		P _s		
EPSA30150-2,5	150/5 A	2,5 VA	0,5S	300 g
EPSA30200-2,5	200/5 A	2,5 VA	0,5S	300 g
EPSA30250-2,5	250/5 A	2,5 VA	0,5S	300 g
EPSA30300-2,5	300/5 A	2,5 VA	0,5S	300 g
EPSA30400-2,5	400/5 A	2,5 VA	0,5S	300 g
EPSA30500-2,5	500/5 A	2,5 VA	0,5S	300 g

RELEVANT STANDARD
EN 60051

RELEVANT STANDARD
EN 61010

EPSA30 (150/5A-500/5A) 2,5 VA

660 V AC	MKEH -MH	U_i 720 V		Utest 1min 3 kV	Fs security 5	$1,2 \times I_n$ I_n	Ta -5...+45 °C	I _{th} 60×I _n	I _{din} 2,5×I _{th}	Objašnjenje piktograma	L/O
-------------	-------------	----------------	--	-----------------------	---------------------	---------------------------	-------------------	--------------------------------------	---	---------------------------	-----

TRACON		P _s		
EPSA30150-5	150/5 A	5 VA	0,5S	300 g
EPSA30200-5	200/5 A	5 VA	0,5S	300 g
EPSA30250-5	250/5 A	5 VA	0,5S	300 g
EPSA30300-5	300/5 A	5 VA	0,5S	300 g
EPSA30400-5	400/5 A	5 VA	0,5S	300 g
EPSA30500-5	500/5 A	5 VA	0,5S	300 g

RELEVANT STANDARD
EN 60051

RELEVANT STANDARD
EN 61010

EPSA40 (250/5A-500/5A) 2,5-5 VA

660 V AC	MKEH -MH	U_i 720 V		Utest 1min 3 kV	Fs security 5	$1,2 \times I_n$ I_n	Ta -5...+45 °C	I _{th} 60×I _n	I _{din} 2,5×I _{th}
-------------	-------------	----------------	--	-----------------------	---------------------	---------------------------	-------------------	--------------------------------------	---

TRACON		P _s		
EPSA40250-2,5	250/5 A	2,5 VA	0,5S	300 g
EPSA40300-2,5	300/5 A	2,5 VA	0,5S	300 g
EPSA40400-2,5	400/5 A	2,5 VA	0,5S	300 g
EPSA40500-2,5	500/5 A	2,5 VA	0,5S	300 g
EPSA40250-5	250/5 A	5 VA	0,5S	300 g
EPSA40300-5	300/5 A	5 VA	0,5S	300 g
EPSA40400-5	400/5 A	5 VA	0,5S	300 g
EPSA40500-5	500/5 A	5 VA	0,5S	300 g

EPSA60 (500/5A-1250/5A) 2,5-5 VA

660 V AC	MKEH -MH	U_i 720 V		Utest 1min 3 kV	Fs security 5	$1,2 \times I_n$ I_n	Ta -5...+45 °C	I _{th} 60×I _n	I _{din} 2,5×I _{th}
-------------	-------------	----------------	--	-----------------------	---------------------	---------------------------	-------------------	--------------------------------------	---

TRACON		P _s		
EPSA60500-2,5	500/5 A	2,5 VA	0,5S	400 g
EPSA60500-5	500/5 A	5 VA	0,5S	400 g
EPSA60600-5	600/5 A	5 VA	0,5S	400 g
EPSA60750-5	750/5 A	5 VA	0,5S	400 g
EPSA60800-5	800/5 A	5 VA	0,5S	400 g
EPSA601000-5	1000/5 A	5 VA	0,5S	400 g
EPSA601200-5	1200/5 A	5 VA	0,5S	400 g
EPSA601250-5	1250/5 A	5 VA	0,5S	400 g

Digitalni multimeter



TRACON	xdigit	V	I	Ω	9 V 6F22	115×65×35 mm	170 g
--------	--------	---	---	---	----------	--------------	-------



Pozadinsko osvet



RELEVANT STANDARD
EN 61010

DC V test	200 mV, 2 V, 20 V, 200 V, 500 V
AC V test	200 V, 500 V
DC A test	200 μA, 2 mA, 20 mA, 200 mA, 10 A
Ω test	200 Ω, 2 kΩ, 20 kΩ, 200 kΩ, 20 MΩ
test	3 V / 1 mA
	3 V / 50 HZ / 560 kΩ

Digitalni multimeter



TRACON	xdigit	V	I	Ω	9 V 6F22	150×75×50 mm	270 g
--------	--------	---	---	---	----------	--------------	-------



Pozadinsko osvet



RELEVANT STANDARD
EN 61010

DC V test	200 mV, 2 V, 20 V, 200 V, 500 V
AC V test	200 V, 500 V
DC A test	200 μA, 2 mA, 20 mA, 200 mA, 10 A
Ω test	200 Ω, 2 kΩ, 20 kΩ, 200 kΩ, 20 MΩ
test	2,5 V / 1 mA
	5 V / 50 HZ / 560 kΩ

Digitalni multimeter

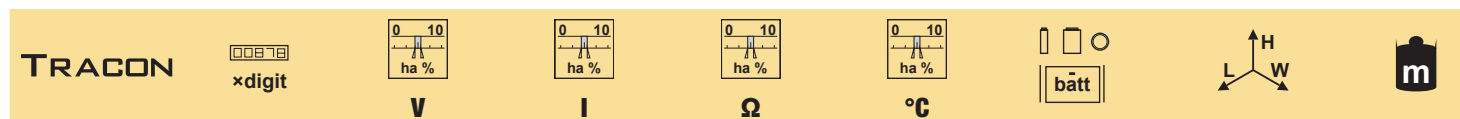
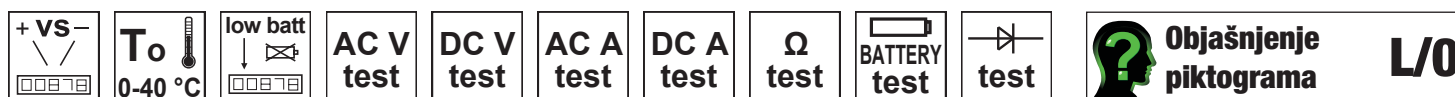

EM420A × 3,5 ±(1,2%+5d) ±(3%+10d) ±(1,5%+5d) ±(5%+4d) 1,5 V, 3×AAA 158×75×35 mm 200 g

DC V test	aut. 0,2-2-20-200-600 V
AC V test	aut. 2-20-200-600 V
AC A test DC A test	200μ-2m-20m-200m-2-10 A
Ω test	0,2-2-20-200-2000-20000 kΩ
°C/°F test	-20...1000 °C / -4...1832 °F
hFE test	2 μA / 1 V
BATTERY test	1,5-3 V / 30 mA 9 V / 12 mA
test	1,5 V
AUTO OFF	10 min.



RELEVANT STANDARD
EN 61010

Funkcije tastature

- dugme** ON-OFF sklopka
- pozadinsko osvet** ON-OFF pritisnati 2 sekunde
- FUNC.** Promena DC-AC ili °C/°F

- RANGE** promena mernog opsega.
- MAX** Zadržava maksimalnu merenu vrednost.
- DATA** Zadržava trenutnu merenu vrednost

Digitalni adapter strujnih klješta za instrument tipa EM420A

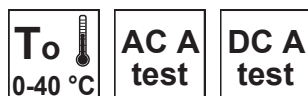

EM264 ±(2,5%+3d) 9 V, 1×6F22 186×73×40 mm 350 g

Digitalni adapter strujnih klješta je dopunski pribor za instrument tipa EM264, pomoću kojih se može meriti AC/DC struja bez prekida voda.

DC A test	40-400 A
AC A test	40-400 A
40 A	10 mV/A
400 A	1 mV/A



Tasterske funkcije
DC ZERO
IKON

podešavanje „0” položaja pri DC merenja
promena mernog opsega



Digitalna merna kješta

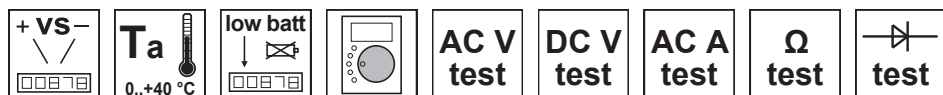

TRACON	xdigit	V	I	Ω	°C	batt		
EM306B	× 3,5	±(1,2%+3d)	±(5%+5d)	±(1,5%+2d)	–	3 V, 3×CR2032	151×65×34 mm	127 g



RELEVANT STANDARD
EN 61010

DC V test	600 V
AC V test	600 V
AC A test	20-200-400 A
Ω test	2-200 kΩ
test	3 V

Funkcije tastature
HOLD sačuva trenutnu vrednost

Digitalna merna kješta



TRACON	xdigit	V	I	Ω	°C	batt		
LF266	× 3,5	±(2%+5d)	±(2,5%+5d)	±(1,2%+5d)	–	9 V, 1×6LA61	240×90×40 mm	320 g







RELEVANT STANDARD
EN 61010

DC V test	1000 V
AC V test	750 V
AC A test	200-1000 A
Ω test	0,2-20 kΩ

Funkcije tastature
HOLD sačuva trenutnu vrednost

Detektor vodova

TRACON    

EM422A 1,5 V, 2×AAA 3 V, 4×LR44 151×65×34 mm 127 g

Detektor služi za ispitivanje nenapajanih vodova. Uređaj se sastoji od predajnika i prijemnika. Pod idealnim uslovima osetljivost uređaja je do 30 cm. Rezultat u velikoj meri zavisi od okolnosti, na pr. Izolacija, drugi obližnji vod, itd.

PREDAJNIK (Transmitter)

Predajnik sadrži pet adaptera za priključenje na provodnik.

- RJ11 priključak
 - Koaksijalni priključak
 - Dve krokodil štipaljke
 - Autoindustrijski sigurnosni priključak
- Adapteri su ispod prednje ploče.



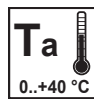

Prijemnik (Receiver)

Za aktivaciju prijemnika pritisnite **TEST** dugme, tada će prijemnik, da detektuje signal predajnika. Pomerajte prijemnik u smeru voda koji želite detektovati. Ukoliko vod nije u prekidu, čuje se zvučni signal i povećava se jačina svetlosti **LED**-a.
Osetljivost se može podesiti pomoću dugmeta **Sensitivity knob**.



RELEVANT STANDARD
EN 61010

Infra termometar

TRACON     









HM-01 9 V, 1×6F22 -20 °C ... +320 °C -4 °F ... +608 °F 45×155×90 mm 150 g

- Merenje temperature bez kontakta, preklop °C/°F
- Čist LCD monitor potrebnog kontrasta, sa plavim pozadinskim osvetljenjem
- laserski spot nišan za tačnost upotrebe
- signal slabe napunjenosti akumulatora
- Funkcija Data- Hold; transportna torba









RELEVANT STANDARD
EN 61010

Ručni digitalni multimetar sa svjetiljkom

 **Objašnjenje piktograma** **L/0**

TRACON       

FV-03 × 3,5 ± (1,5 % + 3 d) ± (1,2 % + 5 d) ± (2,0 % + 2 d) 3 V, 1×CR 2032 155×55×26 mm 130 g

DC V test	200 mV–2 V–20 V–200 V–600 V
AC V test	2 V–20 V–200 V–600 V
AC A test DC A test	20 mA–200 mA
Ω test	200 Ω, 2 kΩ, 20 kΩ, 200 kΩ, 2 MΩ, 20 MΩ
Diode test	1,5 V; 0,5 mA



RELEVANT STANDARD
EN 61010

Ispitivač faze, odvijač (šrafciğer)



RELEVANT STANDARD
EN 61010



Objašnjenje
piktograma

L/O

TRACON



FK-10

-

190 × 18 × 18 mm

30 g

AC V
test

0-250 V

Tester napona



Funkcije tastature

Dugme ON-OFF
Osvetljenje



Objašnjenje
piktograma

L/O

TRACON



GK6A

1,5 V, 2 × AAA

153 × 36 × 24 mm

70 g

AC V
test

100-1000 V

Indukcijski kontrolni aparat



RELEVANT STANDARD
EN 61010



Objašnjenje
piktograma

L/O

TRACON



FV-01

-

130 × 18 × 15 mm

15 g

DC V
test

12-36-55-110-230 V

AC V
test

12-36-55-110-230 V

Aparat za detektiranje napona



TRACON



FV-05

-

142 × 21 × 18 mm

30 g

AC V
test

200-600 V

Namijenjen je za provjeru prisutnosti napona od 200 V do 600 V bez metalnog kontakta, npr. na izoliranim vodičima. Napon je prisutan ukoliko ispitni vršak svoju boju promijeni u crvenu (bez treptanja).

Probna svjetiljka za automobile



Objašnjenje
piktograma

L/0

TRACON



FV-06

-

118 × 11 × 11 mm

30 g

DC V
test

6-24 V



Vreme neprekidnog rada: maks. 10 sekundi



TRACON APPLICATION



TRACON
ELECTRIC®

Obnovljena web stranica!



- **Novi izgled**
- **Optimiziran prikaz na tablet - i mobilnim uređajima**
- **Pošireni tehnički podaci artikala**
- **Pretraživač sopstvenog razvoja**
- **Filteri karakteristike**
- **Brža i preglednija kupovina**
- **Modul za upoređenje**

www.traconelectric.com