

C/O Vysvetlenie piktoqramov hlavičky tabuliek



Dĺžka



Farba

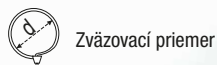

Zväzovací priemer

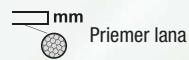

Priemer lana



Hmoždinka

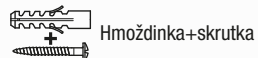

Hmoždinka+skrutka

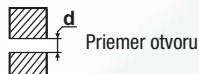

Priemer otvoru

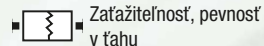

Zaťažiteľnosť, pevnosť v ťahu

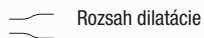

Rozsah dilatácie



Odporúčaná veľkosť skrutky

C/O Piktoqramy technických parametrov

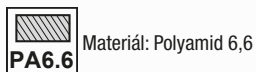

Materiál: Polyamid 6,6



Materiál: Polyetylén

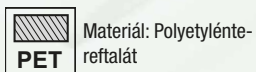

Materiál: Polyetylénte-reftalát

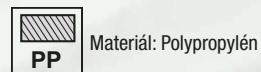

Materiál: Polypropylén



Materiál: oceľ

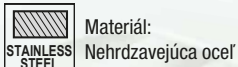

Materiál: Nehrzdavejúca oceľ



Teplota okolia

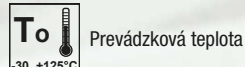

Prevádzková teplota



UV-odolné



Teplota tavenia

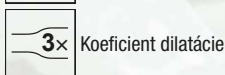

Koeficient dilatácie



Dielektrická pevnosť

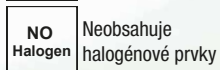

Neobsahuje halogénové prvky

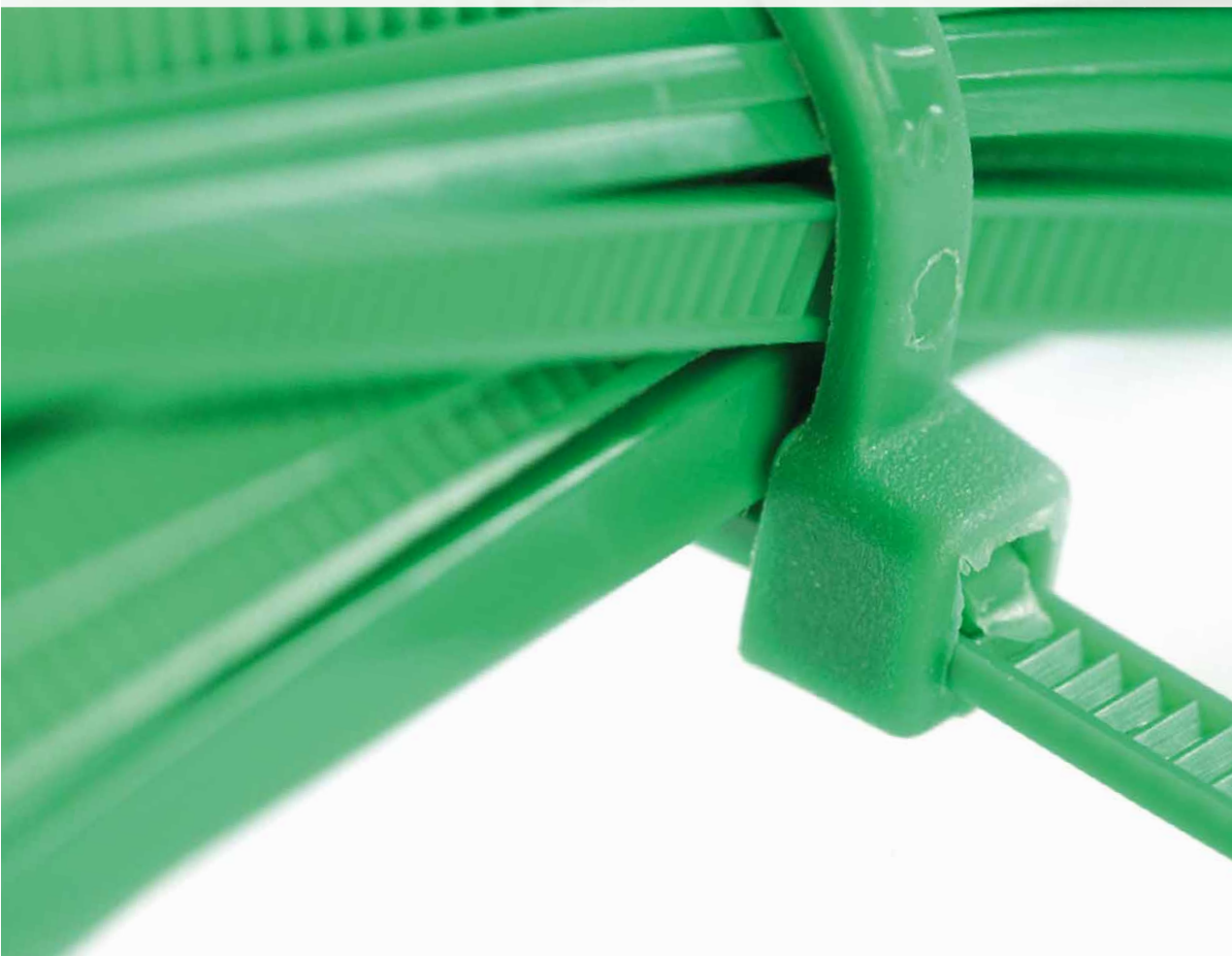



Klasické sťahovacie pásky 2

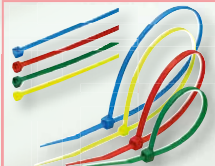

Klasické sťahovacie pásky farebné 3



Sťahovacie pásky s kovovým jazýčkom, čierne 4



Sťahovacie pásky pre viacnásobné použitie 5



Sťahovacie pásky perličkové, rozpinacie 5



Sťahovacie pásky so zvýšenou tepelnou odolnosťou 6



Sťahovacie pásky nehorľavé 6



Sťahovacia páska so zastrávkovou hlavou 6



Sťahovacie pásky so štítkom 7



Oceľové sťahovacie pásky 7



Sťahovacie pásky so samoupínacou pätkou 8



Páska na zväzovanie káblov na suchý zips 9



Samolepiaca prichytka káblov 9



Skrutkovacie pätky k sťahovacím páskam 10



Zatlačiacie hmoždinky k sťahovacím páskam 11



Prichytka na káble, s klincom 12



Samoupínacie prichytky 12



Hmoždinky na uchytenie káblov 13



Zatlačiacie hmoždinky do sadrokartónu 14

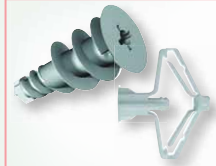

Hmoždinky do sadrokartónu 14



Hmoždinky lemované, so šesťhrannou skrútkou 15



Hmoždinky nylon s vysokou zaťažiteľnosťou 15



Hmoždinky lemované 16



Hmoždinky so zatlačovacou skrútkou 17



Nerezové kovové hmoždinky 18



Závitové tyče a prislúšenstvá 19



Lanové očnice 20



Háky "S" 21



Lanové svorky, profil "U" 21



Lanové svorky dvoj-skrutkové "duplex" 22



Karabiny s pružinou 23



Napínacie skrútky 23



Pozinkovaná dlhočlánková reťaz 24



Káblové zväzovacie špirály 25



Pletená zväzovacia sieťka 25

Klasické sťahovacie pásky

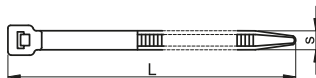

TRACON				
80PR	81PR	75 × 2.2 mm	0.75-15 mm	35 N
120PR	121PR	98 × 2.5 mm	1-21 mm	45 N
130PR	131PR	135 × 2.6 mm	1-32 mm	45 N
150PR	151PR	140 × 3.6 mm	2-36 mm	80 N
160PR	161PR	160 × 2.6 mm	1-40 mm	45 N
170PR	171PR	200 × 3.6 mm	2-50 mm	80 N
180PR	181PR	180 × 7.8 mm	3.5-45 mm	250 N
190PR	191PR	200 × 4.8 mm	3-50 mm	110 N
200PR	201PR	200 × 2.6 mm	1-52 mm	45 N
210PR	211PR	290 × 4.8 mm	3.5-79 mm	110 N
220PR	221PR	360 × 4.8 mm	3.5-103 mm	110 N
230PR	231PR	290 × 3.6 mm	2-80 mm	80 N
250PR	251PR	250 × 4.8 mm	3-68 mm	110 N
260PR	261PR	365 × 7.8 mm	8-100 mm	250 N
270PR	271PR	260 × 2.5 mm	3-73 mm	45 N
280PR	281PR	280 × 8.0 mm	4-65 mm	180 N
300PR	301PR	300 × 7.8 mm	5-80 mm	250 N
370PR	371PR	370 × 3.6 mm	5-108 mm	80 N
430PR	431PR	430 × 4.8 mm	3.5-115 mm	110 N
450PR	451PR	450 × 7.8 mm	35-130 mm	250 N
530PR	531PR	550 × 8 mm	10-160 mm	250 N
550PR	551PR	550 × 4.6 mm	4-160 mm	110 N
580PR	581PR	580 × 12.4 mm	9-168 mm	450 N
610PR	611PR	610 × 8.8 mm	9-181 mm	350 N
760PR	761PR	780 × 9 mm	35-233 mm	350 N
850PR	851PR	850 × 12.6 mm	40-255 mm	450 N
1000PR	1001PR	1000 × 12.6 mm	40-302 mm	450 N

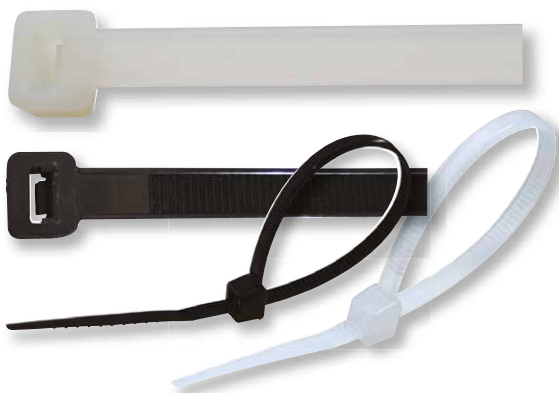

RELEVANT STANDARD
EN 62275



B/20

TG008

TG007

**Vlastnosti:**

Trvale odolné voči olejom, benzínu, derivátom uhľovodíka, syntetickým rozpúšťadlám, plesniam, alkoholom.

Krátkodobo odolné voči organickým kyselínám, zásadám, anorganickým soľam a organickým látkam.

Nie sú odolné voči anorganickým kyselínám a oxidačným prípravkom.

Klasické sťahovacie pásky farebné

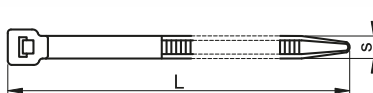
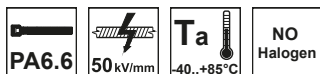

TRACON				
120K	98 × 2.5 mm	1-21 mm	45 N	
150P	140 × 3.6 mm	2-36 mm	80 N	
150Z	140 × 3.6 mm	2-36 mm	80 N	
170P	200 × 3.6 mm	2-50 mm	80 N	
170Z	203 × 3.6 mm	2 - 52 mm	80 N	
190K	200 × 4.8 mm	3-50 mm	110 N	
190Z	203 × 4.6 mm	2 - 52 mm	110 N	
200K	200 × 2.6 mm	1-52 mm	45 N	
230NZ	290 × 3.6 mm	2-80 mm	80 N	

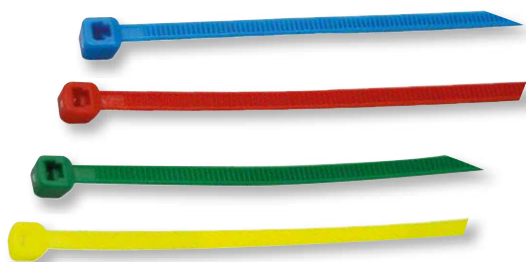

RELEVANT STANDARD
EN 62275

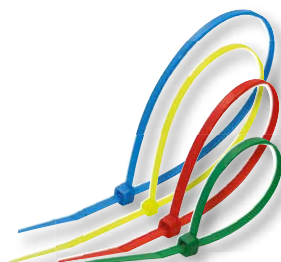

Sťahovacie pásky s kovovým jazýčkom, prírodné

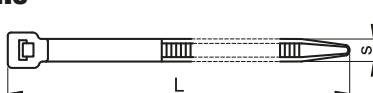
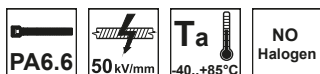

TRACON			
T92	92 × 2.4 mm	2-16 mm	35 N
T140	140 × 3.6 mm	2-29 mm	75 N
T186	186 × 4.8 mm	3.5-45 mm	110 N
T200	200 × 2.4 mm	2-50 mm	35 N
T208	208 × 3.6 mm	2-50 mm	75 N
T281	281 × 3.6 mm	2-76 mm	75 N
T293	293 × 4.8 mm	3.5-78 mm	110 N
T338	338 × 7.6 mm	3.5-120 mm	110 N
T360	360 × 4.8 mm	3.5-102 mm	110 N



Sťahovacie pásky s kovovým jazýčkom, čierne

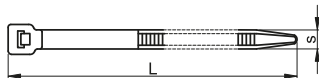

TRACON				
TU92		92 × 2.4 mm	2-16 mm	35 N
TU140		140 × 3.6 mm	2-29 mm	75 N
TU186		186 × 4.8 mm	3.5-45 mm	110 N
TU200		200 × 2.4 mm	2-50 mm	35 N
TU208		208 × 3.6 mm	2-50 mm	75 N
TU281		281 × 3.6 mm	2-76 mm	75 N
TU293		293 × 4.8 mm	3.5-78 mm	110 N
TU338		338 × 7.6 mm	3.5-120 mm	110 N
TU360		360 × 4.8 mm	3.5-102 mm	110 N



Sťahovacie pásky s dvoma jazýčkami

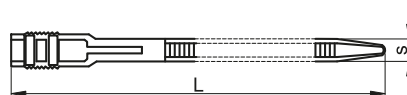

TRACON				
132-12		132 × 9.0 mm	4-27 mm	120 N
180-12		180 × 9.0 mm	5-45 mm	150 N
265-12		260 × 9.0 mm	25-65 mm	250 N
300-12		300 × 9.0 mm	25-80 mm	225 N
360-12		350 × 9.0 mm	25-93 mm	250 N



RELEVANT STANDARD
EN 62275

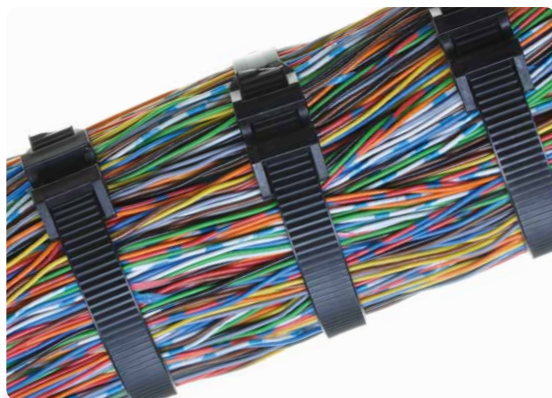

Sťahovacie pásky pre viacnásobné použitie

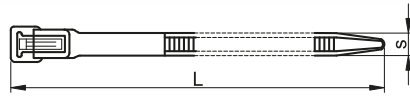

TRACON				
180-NY	181-NY	200 × 7.5 mm	10-50 mm	10-45 N
260-NY	261-NY	250 × 7.5 mm	10-65 mm	10-45 N
280-NY	281-NY	300 × 7.5 mm	10-70 mm	10-45 N
350-NY	351-NY	350 × 8 mm	10-120 mm	10-45 N

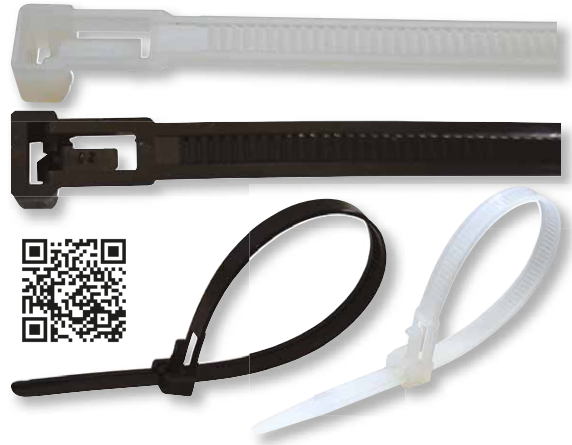

Sťahovacie pásky perličkové, rozpinacie

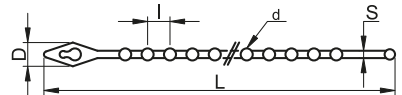

TRACON		L × S (mm)	d (mm)	D (mm)	I (mm)		
100N-GY	100F-GY	1.2 × 100	2.5	4.85	3	3 - 25 mm	45 N
120N-GY	120F-GY	120 × 1.3	2.5	5.5	3	6-25 mm	40 N
150N-GY	150F-GY	150 × 2	3	7.5	4.5	8-35 mm	40 N
160N-GY	160F-GY	1.7 × 150	2.6	7.73	4	4 - 38 mm	40 N
180N-GY	180F-GY	180 × 2	3	7.5	4.5	8-45 mm	40 N
200N-GY	200F-GY	1.8 × 200	2.5	7.63	5	5 - 59 mm	40 N



Sťahovacie pásky so zvýšenou tepelnou odolnosťou

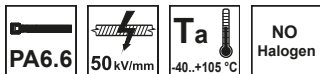

TRACON				
260T	365 × 7.8 mm	8-100 mm	135 °C (5-8 min)	250 N

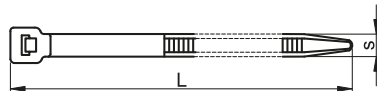
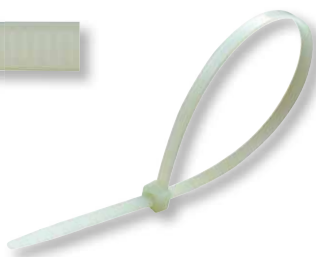

RELEVANT STANDARD
EN 62275

Sťahovacie pásky nehorľavé

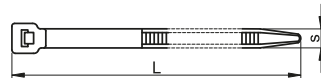
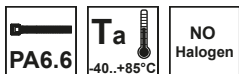

TRACON			
150L	3.6 × 150mm	4 - 36 mm	80 N
200L	4.6 × 200mm	4 - 52 mm	110 N
300L	4 × 300mm	4 - 81 mm	110 N
380L	7.6 × 380mm	9 - 108 mm	250 N



Sťahovacia páska so zastrkávacou hlavou

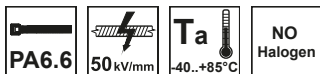

TRACON				
BK-130	130 × 4.8 mm	d=6 mm	3-25 mm	200 N

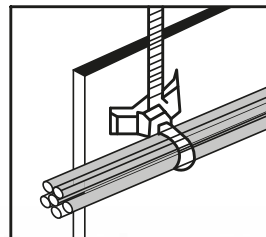
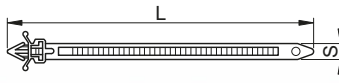
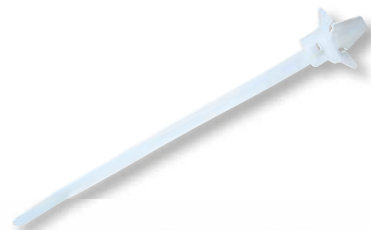

Sťahovacie pásky so štítkom



Vysvetlivky piktogramov

C/O

TRACON	L × S (mm)	a (mm)	b (mm)		
120J	110 × 2.5	8	25	1-20 mm	40 N
190J	190 × 3.6	27	13	10-48 mm	70 N
200J	210 × 2.5	15	30	5-45 mm	40 N

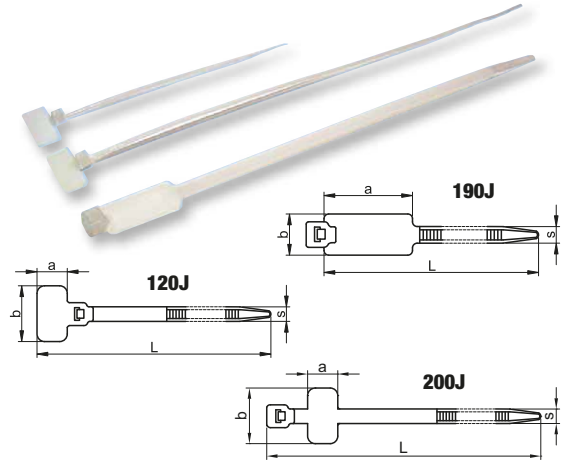

Oceľové sťahovacie pásky

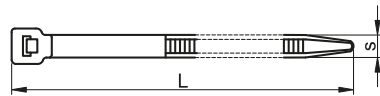

TRACON			
F125	125 × 4.6 mm	15 - 38 mm	350 N
F200	200 × 4.6 mm	15 - 61 mm	350 N
F201	200 × 7,9 mm	15 - 61 mm	450 N
F290	290 × 4.6 mm	15 - 90 mm	350 N
F291	290 × 7.9 mm	15 - 90 mm	450 N
F520	520 × 4.6 mm	15 - 163 mm	350 N
F521	520 × 7,9 mm	15 - 163 mm	450 N
F840	840 × 4.6 mm	15 - 265 mm	350 N
F841	840 × 7.9 mm	15 - 265 mm	450 N



B/20

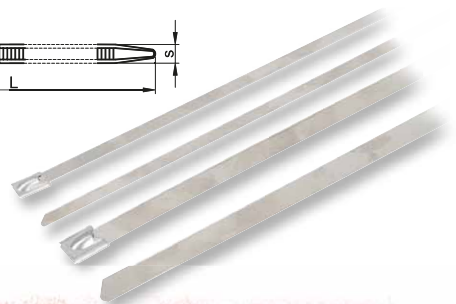
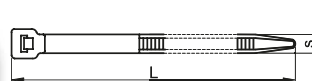

Skrutkovateľná sťahovacia páska

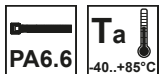

TRACON					
110-CS		110 × 2.5 mm	3 - 19 mm	45 N	M2.5
150-CS		150 × 3.6 mm	3 - 35 mm	80 N	M4
160-CS		160 × 4.8 mm	3 - 36 mm	110 N	M5
200-CS		200 × 4.8 mm	3 - 49 mm	110 N	M5
300-CS		300 × 4.8 mm	3 - 82 mm	110 N	M5
310-CS		300 × 7.6 mm	8 - 78 mm	250 N	M6
370-CS		370 × 4.8 mm	3 - 103 mm	110 N	M5
400-CS		400 × 7.6 mm	8 - 109 mm	250 N	M6

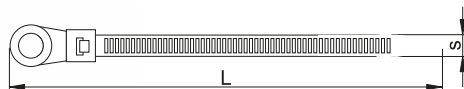

Sťahovacie pásy so samoupínacou pätkou

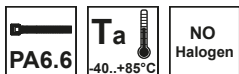

TRACON				
CSKT		4.8 × 200mm	3 - 49 mm	110 N

Maximálna hrúbka okraja: 3 mm.

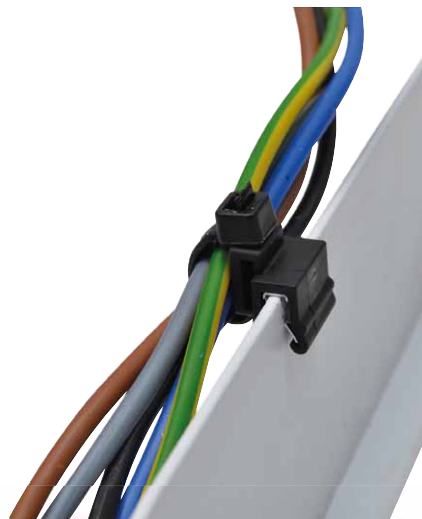

Páska na zväzovanie káblov na suchý zips



Vysvetlivky piktogramov

C/O

TRACON			
TKR130		130 × 12,5 mm	35 mm
TKR200		200 × 12,5 mm	35 mm
TKR300		300 × 12,5 mm	89 mm
TKR310		300 × 17 mm	92 mm
TKR-12T		22,8 m × 12,5 mm	-
TKR-20T		25 m × 20 mm	-



Samolepiaca prichytka káblov



Vysvetlivky piktogramov

C/O

TRACON		L (mm)	W (mm)	H (mm)
OKT15		15	24	9
OKT20		20	24	9
OKT25		25	24	9
OKT28		28	24	9

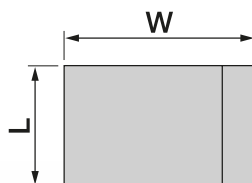
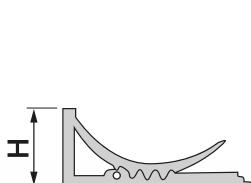

Skrutkovacie pätky k sťahovacím páskam

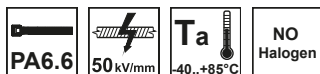

TRACON	a (mm)	b (mm)	L (mm)	d (mm)	D (mm)
CSTALP	15	10	5.1	3.5	7
CSTALP-3	12.8	7	4	3.3	5.8
CSTALP-2	23	16	9	6.3	9.8
CSTALP-4	16	11	5.3	3.5	7
CSTALP-5	22	15	8.3	5	9.5
CSTALP-6	26	16	9.5	5	10.7

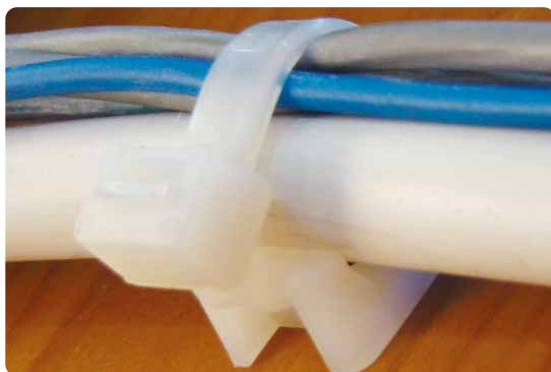
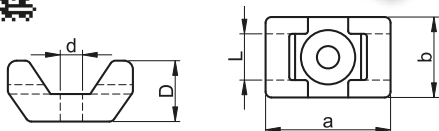
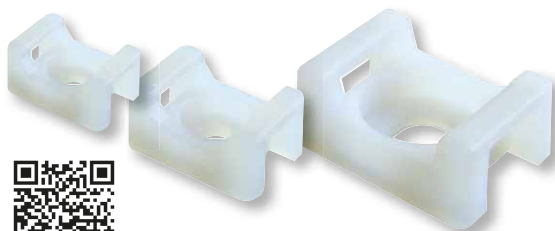

Dvojstupové samolepiace pätky k sťahovacím páskam



TRACON		a (mm)	b (mm)	L (mm)	d (mm)	D (mm)
TALP190-2		18.7	18.7	4	4.4	5.7
TALP191-2		18.7	18.7	4	4.4	5.7
TALP270-2		26.5	26.5	5.8	4.3	8.1
TALP271-2		26.5	26.5	5.8	4.3	8.1

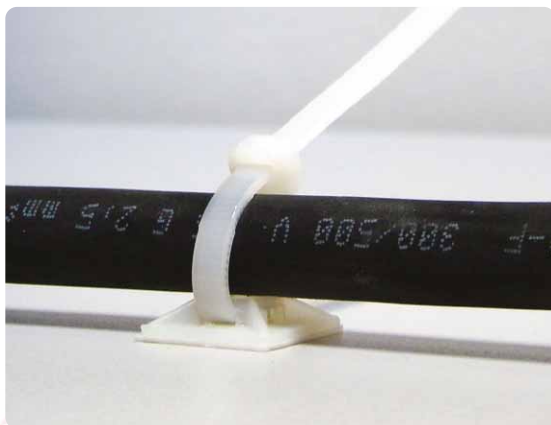
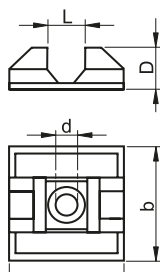
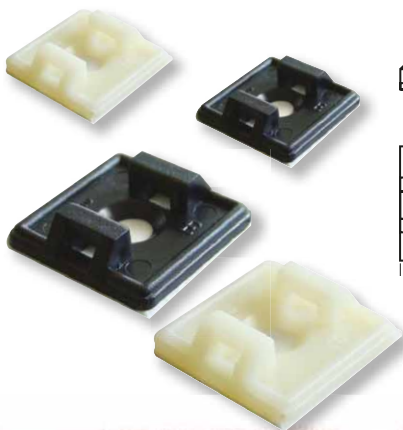

Štvorstupňové samolepiace pätky k sťahovacím páskam



TRACON		a (mm)	b (mm)	L (mm)	d (mm)	D (mm)
TALP190		20	20	5	2.9	6.1
TALP191		20	20	5	2.9	6.1
TALP200		19	19	4.3	5	6
TALP201		19	19	4.3	5.7	6.5
TALP270		25	25	6.2	3.5	7.5
TALP271		25	25	6.2	3.5	7.5
TALP280		28	28	5.2	5.7	6.5
TALP281		28	28	5.2	5.7	6.5

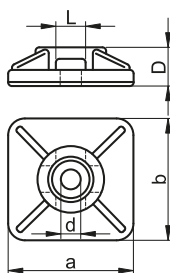

Ztláčacie hmoždinky k sťahovacím páskam



TRACON			a (mm)	b (mm)	c (mm)	W ₁ (mm)	W ₂ (mm)	L (mm)	D (mm)
5458		8 mm	10.6	6.3	3.1	12.8	12.6	43.8	9.9
5458N		7 mm	9.8	6.4	2.1	15.4	11.1	38.0	7.9
8138		7 mm	10.2	6.4	3	14.6	11	38	9.9
9843		8 mm	10.3	6.5	3.2	12.8	12.9	43.3	9.7

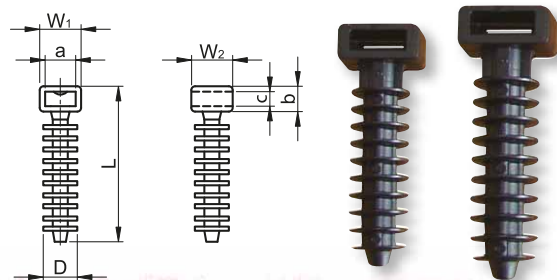
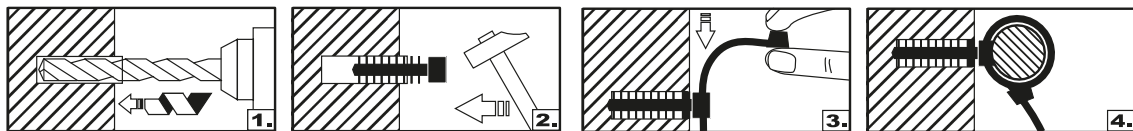

Príchytky na káble, s klincom

TRACON			a (mm)	b (mm)
100 pcs	20 pcs			
NOF	NOF-20		2.5	4.5
N1	N1-20		6	7.3
N2	N2-20		8	8.1
N3	N3-20		9	8.3
N4	N4-20		11	10



N1..N4



NOF

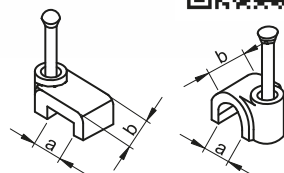

Samoupínacie príchytky



TRACON		D (mm)	W (mm)	L (mm)	H (mm)
CSS-16		16	29.3	12.9	21.7
CSS-20		20	33	12.9	24.2
CSS-25		25	37.5	12.9	27.9

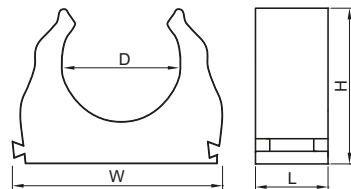

Samolepiace klipsy

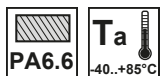

TRACON		d (mm)	W (mm)	L (mm)
TKCR-0708		7-8	20	25

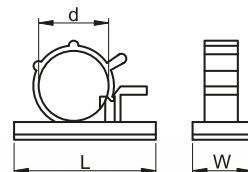

Rozpínacie káblové príchytky

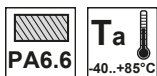

TRACON		d (mm)	L (mm)	H (mm)
TKCRZ-15		15	28	28.5
TKCRZ-18		18	28	33
TKCRZ-22		22	34	37
TKCRZ-28		28	38,5	45
TKCRZ-32		32	38	47.5
TKCRZ-35		35	41	49

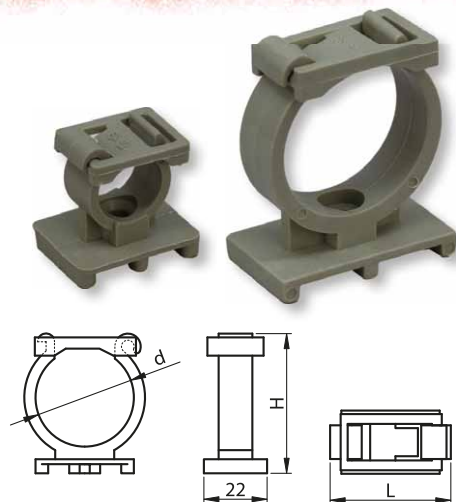

Umelohmotné káblové príchytky

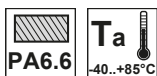

TRACON		a (mm)	b (mm)	L (mm)	I (mm)	H (mm)	W (mm)
BCSV-3		10-18	18.6	26.4	16.2	19.8-37.5	17.7
BCSV-4		19-31	28.8	39.4	15.1	39.5-51.6	18.2

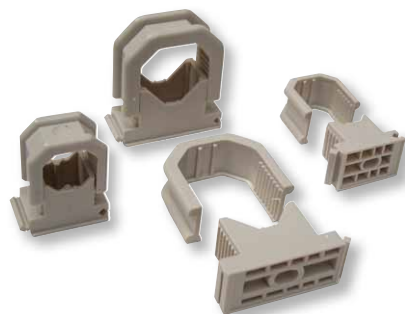
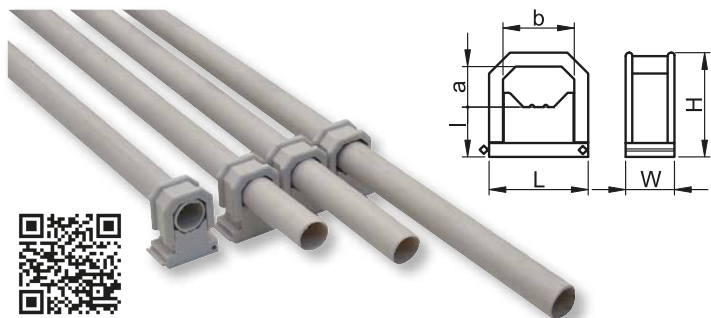

Hmoždinky na uchytenie káblov



TRACON		d ₁ (mm)	d ₂ (mm)	B (mm)	L (mm)
KRT		6	6	10	36.5
KRT8		8	7.7	12.2	42.7

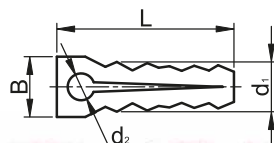

Zatlkacie hmoždinky do sadrokartónu

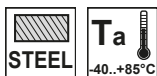

TRACON	D × L (mm)	
GTL30	10,5 × 30	3,5-4 mm
GTL40	10,5 × 40	3,5-4 mm
GTL43	16 × 43	3,5-4 mm

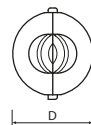
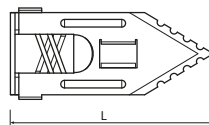

Hmoždinky do sadrokartónu

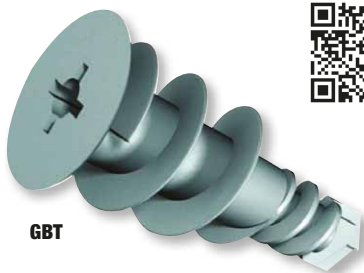
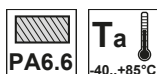

GBT



GSZT

TRACON	Popis	D × L (mm)	d × l (mm)*
			
GBT	Hmoždinka skrutkovacia do sadrokartónu	16 × 36	4 × 35
GSZT	Hmoždinka s krídelkami do sadrokartónu	10 × 55	4 × 50

* Rozmery odporúčanej skrutky

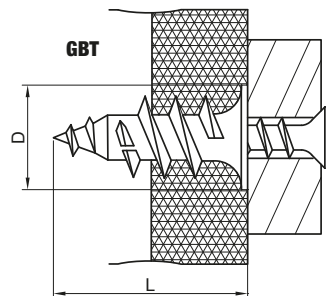
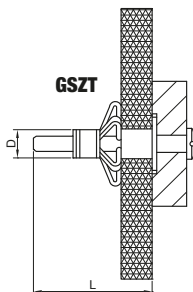

Skrutky do sadrokartónu, do kovových a drevených konštrukcií



GCSS90

GCSW35

GCSS45

GCSW45

GCSS25

GCSW25

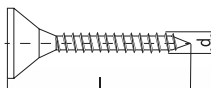

TRACON			
		∅ d1	l (mm)
GCSS25	Kovové konštrukcie	3,5	25
GCSS35			35
GCSS45			45
GCSS55			55
GCSS70			70
GCSS90			90
GCSW25	Drevené konštrukcie	3,5	25
GCSW35			35
GCSW45			45
GCSW55			55
GCSW70			70
GCSW90			90

Hmoždinky lemované, so šesťhrannou skrutkou

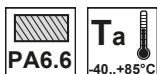

TRACON	D × L (mm)	d × l (mm)
T10080P	10 × 80	6.8 × 95
T10100P	10 × 100	6.8 × 115
T10120P	10 × 120	6.8 × 135
T10140P	10 × 140	6.8 × 155
T10160P	10 × 160	6.8 × 175
T10200P	10 × 200	6.8 × 215
T10240P	10 × 240	6.8 × 255
T10300P	10 × 300	6.8 × 315

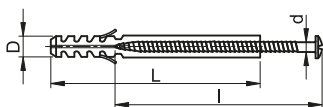

Hmoždinky s vysokou zaťažiteľnosťou

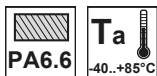

TRACON	D × L (mm)	d × l (mm)*
T5-UNI	5 × 25	3.5 × 35
T6-UNI	6 × 30	4 × 40
T8-UNI	8 × 40	5 × 50
T10-UNI	10 × 50	6 × 60

* Rozmery odporúčanej skrutky

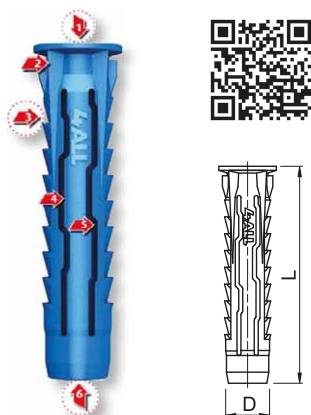

Jedinečné vyhotovenie vnútra, s vynikajúcim uložením použitej skrutky.



Krídlička proti otočeniu, ktoré fixujú hmoždinu v každom type muriva, ako aj v mäkkých materiáloch.



Ryhovanie pod hlavou zvyšuje bezpečné zafixovanie hmoždinky v každom materiáli.



Hmoždinka sa doťahovaním skrutky skracuje a plášť sa v dutých materiáloch rozširuje, čo umožňuje vynikajúce fixovanie.



Rozširovanie do 4 strán umožňuje použiteľnosť v murive ľubovoľného typu a materiálu.



Zosilnený hrot hmoždinky zabezpečuje vhodné vedenie skrutky pri montáži.



Betón



Duté murivo



Stavebná doska

Náš sortiment sa neustále a rýchlo rozrastá. Predložený katalóg odráža stav k januáru 2023. Pre aktuálne informácie, prosím, navštívte našu internetovú stránku!

NAČÍTAJTE KÓD!

- Pozrite si naše novinky!
- Buďte informovaní!



Hmoždinky klasické

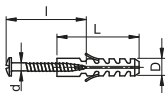
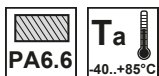

TRACON		D × L (mm)	d × l (mm)
T6-PA	T6CS-PA	6 × 30	4 × 40
T8-PA	T8CS-PA	8 × 40	5 × 50
T10-PA	T10CS-PA	10 × 50	5.5 × 60
T12-PA	-	12 × 60	-
T14-PA	-	14 × 75	-



Vysvetlivky piktogramov **C/O**



Hmoždinky lemované

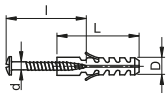
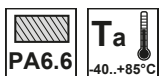

TRACON		D × L (mm)	d × l (mm)
-	T6PCS-PA	6 × 30	4 × 40
T6P-PA	-	6 × 30	4 × 40
T8P-PA	T8PCS-PA	8 × 40	5 × 50
T10P-PA	T10PCSPA	10 × 50	5.5 × 60
T12P-PA	-	12 × 60	-



Hmoždinky uzlovacie

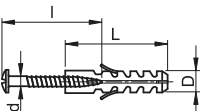
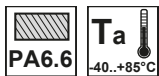

TRACON		D × L (mm)	d × l (mm)
TOP6	TOPCS6	6 × 40	4 × 50
TOP8	TOPCS8	8 × 50	5 × 60
TOP10	TOPCS10	10 × 60	6 × 70





OVO



Hmoždinky štvorhranné

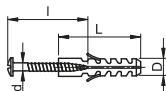
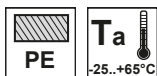

TRACON		D x L (mm)	d x l (mm)
TN6	TNCS6	6 x 23	2.6 x 30
TN8	TNCS8	8 x 34	3.5 x 38
TN10	TNCS10	10 x 42	4.4 x 46
TN12	TNCS12	12 x 52	5.4 x 61
TN14	-	14 x 65	-



Hmoždinky so zatlačacou skrutkou

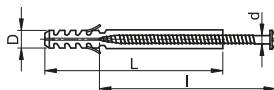
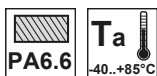

TRACON			TRACON		
	D x L (mm)	d x l (mm)		D x L (mm)	d x l (mm)
TB525	5 x 25	3.5 x 29	TB845	8 x 45	4.9 x 48
TB535	5 x 30	3.5 x 38	TB860	8 x 60	4.4 x 60
TB545	5 x 50	3.5 x 47	TB875	8 x 80	4.7 x 78
TB635	6 x 35	3.7 x 39	TB8100	8 x 100	4.7 x 102
TB645	6 x 40	3.7 x 48	TB8120	8 x 120	4.4 x 122
TB655	6 x 55	3.7 x 58	TB8135	8 x 135	4.4 x 137
TB670	6 x 80	3.2 x 83			



Hmoždinky dlhé, PA6.6

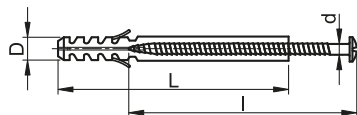

TRACON		D x L (mm)	d x l (mm)
-	THC8100	8 x 100	5.3 x 104
TH8120	THC8120	8 x 120	5.5 x 126
TH8135	THC8135	8 x 135	5.4 x 134
TH10100	THC10100	10 x 100	6.8 x 105
TH10115	THC10115	10 x 115	6.8 x 119
TH10135	THC10135	10 x 135	6.8 x 141
TH10160	THC10160	10 x 160	7 x 165



Hmoždinky s profilovými skrutkami



TRACON		D × L (mm)	d (mm)	l ₁ (mm)	l ₂ (mm)	B (mm)
T6H		6 × 30	3.3	37	24.2	15.4
T6K		6 × 30	3.3	38.5	10	13.4

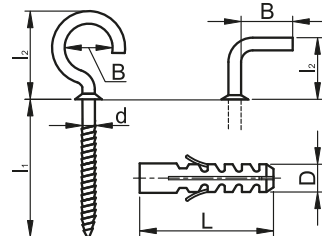

Nerezové kovové hmoždinky



TRACON	d (mm)	l (mm)	M
RFD6	8	25	M6
RFD8	10	30	M8
RFD10	12	40	M10

Samorezky do plechu s plochou hlavou



TRACON	d (mm)	l (mm)
OPCS13	4.2	13
OPCS16	4.2	16
OPCS19	4.2	19
OPCS22	4.2	22
OPCS25	4.2	25
OPCS32	4.2	32



Závitové tyče a príslušenstvá

Závitové tyče

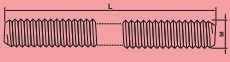
TRACON		M (mm)	l (mm)
SZAL6		6	
SZAL8		8	1.000
SZAL10		10	

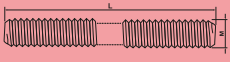

Spojky pre závitové tyče

TRACON		M (mm)	l (mm)
MTOLD6		6	17.9
MTOLD8		8	23.7
MTOLD10		10	30.3



Maticе šest'hornné, samoistiace, pozinkované

TRACON		M
HANYA06		6
HANYA08		8
HANYA010		10



Šest'hornné maticе, pozinkované

TRACON		M
HANYA6		6
HANYA8		8
HANYA10		10



Pružinové podložky

TRACON		M
ALAR6		6
ALAR8		8
ALAR10		10



Ploché podložky

TRACON		M
ALAL6		6
ALAL8		8
ALAL10		10



Vejárové podložky

TRACON		M
ALAF6		6
ALAF8		8
ALAF10		10



Sklápacie závesy do dutých priestorov



TRACON	d (mm)	L (mm)	a (mm)	B (mm)	
TMK	M4	95	20	14	200 N
TMCS	M4	81	20	–	800 N
TMSZ	M4	93	20	14	200 N

Materiál: oceľ, pozinkovaná.

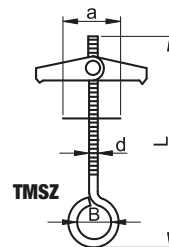
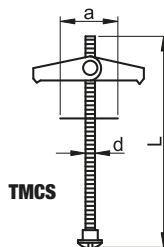
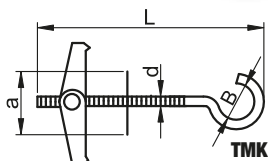

Lanové očnice

TRACON	W (mm)	l (mm)	L (mm)	c (mm)	s (mm)	
SZIV-3	4.5	41.6	46.3	17	1	1 – 3 mm
SZIV-4	5.5	37.7	41.7	15	1	3 – 4 mm
SZIV-5	6.2	37.8	42.4	15	1	4 – 5 mm
SZIV-6	9	42.8	47.5	18.1	1	5 – 6 mm
SZIV-8	9.4	47.7	54.5	19.2	1.5	6 – 7 mm
SZIV-10	12.1	53.8	59.7	21.9	1.5	7 – 9 mm
SZIV-12	17.1	62.4	68.5	28.8	1.5	9 – 12 mm
SZIV-16	21.1	75.7	82.9	39.2	2	12 – 14 mm
SZIV-19	21.6	80.6	90.3	42.2	2.3	16 – 19 mm

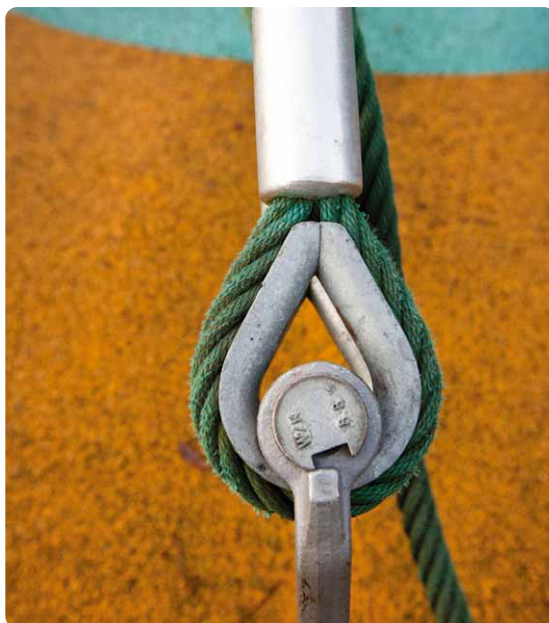
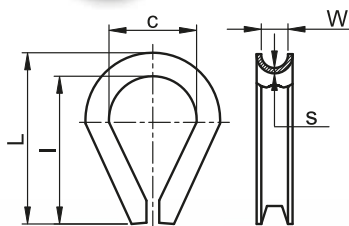

Háky "S"

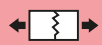
TRACON	d (mm)	L (mm)	l (mm)	m (mm)	D (mm)	
HR3-25	3	26	20.2	3	7	320 N
HR3-30	3	31.1	25.5	4.8	8.8	320 N
HR4-30	4	33.4	25.5	4.8	10	575 N
HR4-35	4	35.3	27.5	5.2	10.2	575 N
HR4-40	4	41	33.3	5.9	10.9	575 N
HR5-45	4.8	46	36.7	6.6	12.5	730 N
HR5-50	5	53.5	44	10.3	15.3	885 N
HR6-80	6	80	69	12	24	1250 N
HR8-100	8	104	88	17	31	2000 N

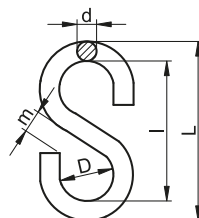

 Vysvetlivky piktogramov **C/O**

 STEEL

Lanové svorky, profil "U"

TRACON	d (mm)	D (mm)	W (mm)	H (mm)	h (mm)	L (mm)	 mm
U03	M4	5.4	9.5	20.4	7.3	18	2-3 mm
U05	M5	7.2	9.6	24.2	7.5	21.5	3.2-5 mm
U06	M5	8.0	11.2	24.2	9.5	23.8	4.5-7 mm
U08	M6	9	12.9	35.4	10.4	27.4	6.3-8 mm
U09	M8	10.5	16.6	37.3	12.7	33	8-9 mm
U11	M8	11	18.4	41	16	36.4	10-11 mm
U13	M10	14.8	20.6	54.7	18.7	42.2	12-14 mm
U14	M10	14.9	24.2	55.2	23	43.7	12-14 mm
U16	M10	18.2	26	62	25.2	49.9	14-16 mm
U19	M12	21.5	29.7	76.8	30.2	54.4	16-19 mm
U22	M12	21.5	31	77.8	33.2	56.7	19-22 mm
U25	M14	27.7	32.8	95.7	34.5	63.3	22-25 mm

Materiál: napínacia skrutka: oceľ, pozinkovaná. Telo svorky: temperovaná zliatina.

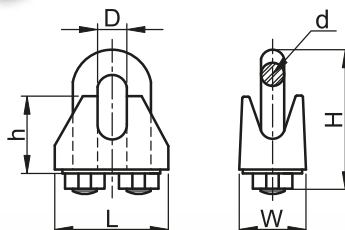

Lanové svorky jednoskrutkové “simplex”

TRACON	d (mm)	b (mm)	B (mm)	H (mm)	L (mm)	k (mm)
BSZ1-2	M4	5.1	13.6	6.1	17.2	13
BSZ1-3	M4	6.4	15.3	7	18.4	13.6
BSZ1-4	M5	10	16.6	6.5	21	17.4
BSZ1-5	M5	10.4	18.7	8.9	24.4	16.9
BSZ1-6	M6	12.5	23.3	9.6	30.2	21.6
BSZ1-8	M8	18.6	30.4	13.5	36.5	29.2

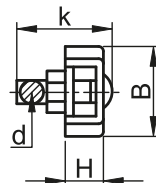
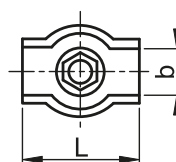

Lanové svorky dvojskrutkové “duplex”

TRACON	d (mm)	b (mm)	B (mm)	H (mm)	L (mm)	k (mm)
BSZ2-2	M4	5.8	12.9	5	36.6	13.4
BSZ2-3	M4	6.4	15.3	6.7	35.2	13.5
BSZ2-4	M5	8.4	17.5	7.1	40	17.6
BSZ2-5	M5	11.9	20.4	8.8	48.8	19.6
BSZ2-6	M6	12.5	23.3	9.6	60.5	21.6
BSZ2-8	M8	18.6	30.4	13.5	73	29.2

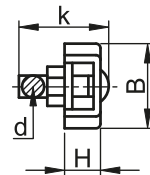
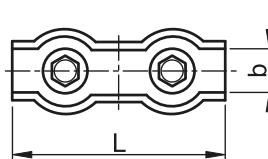

Lanové svorky ploché “AMAX”

TRACON	d (mm)	W (mm)	H (mm)	L (mm)	k (mm)	⌀a
AMAX3	M3	16.1	10.2	28.6	12.7	3 mm (1/8")
AMAX5	M5	17.5	10.7	30.5	12.4	5 mm (3/16")
AMAX6	M6	22.9	12.9	34.9	15.9	6 mm (1/4")

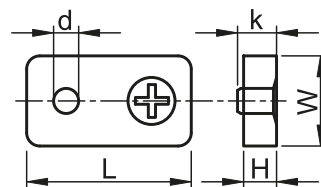

Karabiny s pružinou

TRACON	d (mm)	D (mm)	W (mm)	L (mm)	m (mm)	←  →
RKARA4	4.5	5.8	21.1	42.0	5.5	300 N
RKARA5	5	6.6	26	51.3	7.2	500 N
RKARA6	6	6.9	30.2	62.3	7.7	800 N
RKARA7	7	7.8	35.1	70.7	8.7	1100 N
RKARA8	8	8.1	40.4	80.5	10.2	1400 N
RKARA9	9	9.7	45	90.3	11.7	1700 N
RKARA10	10	11.1	47.3	99.8	13.4	2100 N
RKARA11	11	12.3	57.3	121.2	16.5	2500 N
RKARA12	12	13.9	63.2	142.5	20.8	2700 N
RKARA13	13	15.8	72.8	149.4	24.1	3000 N

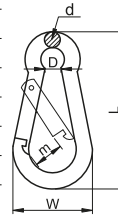





Karabiny so skrutkou

TRACON	d (mm)	D (mm)	W (mm)	L (mm)	←  →
CSKARA3,5	3.5	10.8	17.9	35.5	420 N
CSKARA4	4	11.6	19.7	40.6	850 N
CSKARA5	5	13.6	23.5	50.9	1270 N
CSKARA6	6	14.7	26.7	58.3	1700 N
CSKARA7	7	18.4	32	68.2	2550 N
CSKARA8	8	19.6	36	73.8	3100 N
CSKARA9	9	20.6	39.2	82.2	4250 N
CSKARA10	10	21.6	42.4	89.6	5100 N
CSKARA12	12	23.5	48.3	106.2	6400 N



Napínacie skrutky

TRACON			d (mm)	l (mm)	L (mm)	D (mm)	←  →
							
FSS550	FSH550	FHH550	5	50	92.6	7.8	750 N
FSS570	FSH570	FHH570	5	70	113	8	770 N
FSS660	FSH660	FHH660	6	60	112	10	1050 N
FSS6100	FSH6100	FHH6100	6	100	154	10.2	1800 N
FSS870	FSH870	-	8	70	137	12.3	1200 N
FSS8110	FSH8110	FHH8110	8	110	176	12.3	2000 N
FSS10120	FSH10120	FHH10120	10	120	194	13.3	3000 N
FSS12130	FSH12130	FHH12130	12	130	224	18.3	4450 N
-	FSH16140	-	16	140	265	22	5950 N

Skrutka: oceľ, pozinkovaná. Telo: temperovaná zliatina.



FSS



FHH

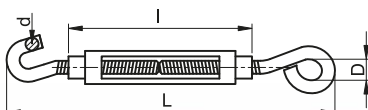

FSH

Pozinkovaná dlhočlánková reťaz



TRACON	A (mm)	B (mm)	C (mm)	(m)
LANC4	4	16	40	25
LANC5	5	20	45	25
LANC6	6	24	54	20



Oceľové lano s PVC obalom



TRACON	∅ d (mm)	(m)
DK0T3	3	100
DK0T4	4	100
DK0T5	5	100



Káblové zväzovacie špirály



TRACON	d (mm)	D (mm)	s (mm)	(m)	(mm)
SPI6	6.2	8.6	1.9	1 m	6 mm
SPI8	8	10.9	2.4	1 m	8 mm
SPI10	10	13.2	2.9	1 m	10 mm
SPI12	12	15.4	2.9	1 m	12 mm
SPI15	15	17.1	2.9	1 m	15 mm
SPI20	20	24	3	1 m	20 mm
SPI25	25	28.7	3	1 m	25 mm

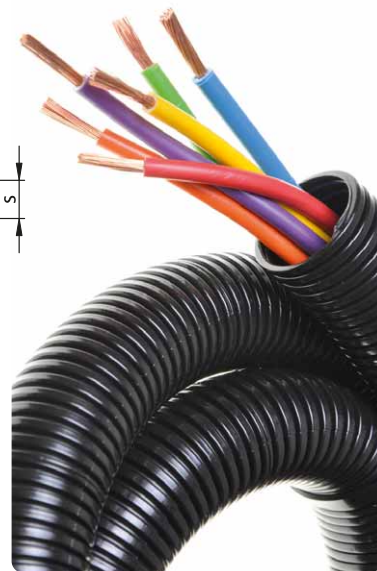
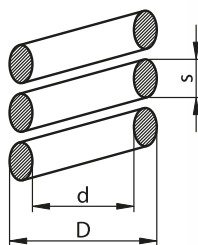

VÝROBA ZÁSUVKOVÝCH ROZVODNÍC PODĽA VAŠICH PREDSTÁV!



Káblové zväzovacie špirály

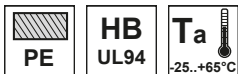

TRACON		D (mm)	d (mm)	W (mm)		
KSPI-4N	KSPI-4F	4.5	3.2	6.8	10 m	4...20 mm
KSPI-6N	KSPI-6F	6.9	5.3	10.3	10 m	7...40 mm
KSPI-8N	KSPI-8F	8.4	6.6	11.7	10 m	12...50 mm
KSPI-10N	KSPI-10F	10.2	8.2	13.4	10 m	13...70 mm
KSPI-12N	KSPI-12F	12.2	9.6	15.9	10 m	15...80 mm
KSPI-16N	KSPI-16F	15.7	12.4	21.6	10 m	20...120 mm

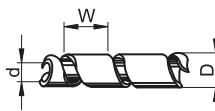

Plastové zväzovacie sietečky

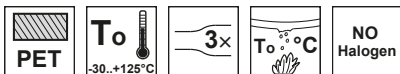

TRACON		
TKH-003	3 mm	2.4 – 6.4 mm
TKH-010	10 mm	4.8 – 15.9 mm
TKH-016	16 mm	9.5 – 25.4 mm
TKH-025	25 mm	15.9 – 36.1 mm
TKH-032	32 mm	19.1 – 44.5 mm



Umožňujú flexibilné uloženie a mechanickú ochranu káblov a vodičov v slab- i silnoprúdových elektrických inštaláciách, v automobilovom priemysle. Rezanie na príslušnú dĺžku je účelne vykonávať horúчим nožom alebo špeciálnym spájkovacím hrotom. Otvorený systém zväzovania umožňuje dobrú ventiláciu a odvedenie tepla od povrchu vodičov.

Pletená zväzovacia sieťka

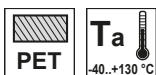

TRACON	
OFK9	9 mm
OFK16	16 mm
OFK25	25 mm
OFK38	38 mm

